

FITS OEM#	SSC#	DESCRIPTION
ACURA SPA		
AQUAHEAT 1 1/2" & AQUAHEAT PLUS 2" PUMPS		
1059	O-2041	Large Pump O-ring
1081	O-2301	Diffuser O-ring
1090-A	MS-1000	Pump Seal

AMERICAN PRODUCTS		
AMERICANA PUMP		
393003	O-2054	Lid O-ring
395005	MS-201	Pump Seal
395012	G-4409	Pot to Volute Gasket
395012	G-5045	Seal Plate O-ring (After 7/75)
397018	O-2026	Volute O-ring
<i>Repair/Service Kit Available...See pg. 73.</i>		

AMERICANA II PUMP		
391015	O-2079	Volute O-ring
391016	O-2066	Body O-ring
391019	O-2218	Lid O-ring
397012	MS-1000	Pump Seal
<i>Repair/Service Kit Available...See pg. 73.</i>		

BRONZE/BRONZE PUMP		
393003	O-2054	Lid O-ring
395012	G-4409	Pot to Volute Gasket
397012	MS-1000	Pump Seal
397028	O-2026	Volute to Seal Plate O-ring
<i>Repair/Service Kit Available...See pg. 73.</i>		

BRONZE/NORYL PUMP		
393003	O-2054	Lid O-ring
395005	MS-201	Pump Seal
395012	G-4409	Pot to Volute Gasket
397028	O-2026	Volute to Seal Plate O-ring
<i>Repair/Service Kit Available...See pg. 73.</i>		

EAGLE PUMP		
392003	O-2095	Volute O-ring
392041	O-2060	Lid O-ring
392048	G-4284	Gasket
397012	MS-1000	Pump Seal
<i>Repair/Service Kit Available...See pg. 73.</i>		

MAXIM PUMP		
391015	O-2079	Body O-ring
391019	O-2218	Lid O-ring
391028	O-2165	Swivel Union O-ring
397012	MS-1000	Pump Seal
570065	O-2090	O-ring
<i>Repair/Service Kit Available...See pg. 73.</i>		

POWERGLAS PUMP		
391016	O-2066	Face Plate O-ring
391019	O-2218	Hair Lint Pot O-ring
397012	MS-1000	Pump Seal
421612	O-2262	Volute O-ring
422160	G-4221	Pump Gasket
468240	O-2195	Slip Body O-ring
<i>Repair/Service Kit Available...See pg. 73.</i>		

FITS OEM#	SSC#	DESCRIPTION
POWER PUMP		
390004	O-2080	Lid O-ring
390008	G-4120	Pump Gasket
390022	O-1060	Body O-ring
390040	O-2195	Diffuser O-ring
510034	O-2115	Adapter O-ring

ULTRA FLOW PUMP		
390066	O-2111	Diffuser Gasket
390060	O-1082	Volute O-ring
393003	O-2054	Lid O-ring
395012	G-4498	Pot to Volute Gasket
397018	O-2026	Volute O-ring
397020	MS-1000	Pump Seal
393006	O-2054	Locking Ring Lid O-rng
570065	O-2090	O-ring
<i>Repair/Service Kit Available...See pg. 73.</i>		

CARTRIDGE FILTER-CARIBE-133, 184, 368, 52, 104 FIBERGLASS		
510135	O-2106	O-ring-133, 184, 368
510136	G-4278	Bulkhead Gasket-133,184,368
510137	G-4237	Bulkhead Gasket-133, 184, 368
530028	O-1039	18" Tank O-ring-133, 184, 368
570031	O-1060	Bottom Seal O-ring-52, 104
570032	O-1014	12" Tank O-rng-52, 104

CARTRIDGE FILTER-COMMANDER-25, 35, 50, 75, 100, 150 SQ. FT.		
570065	O-2090	Gauge Plug O-ring
570067	O-2129	Knob Seal O-ring
570073	O-1059	Tank O-ring
570078	O-2223	Rod O-ring
<i>O-ring/Gasket Kit Available...See pg. 73.</i>		

CARTRIDGE FILTER-COMMANDER II-SPA, ABOVE GROUND-20, 25 SQ. FT.		
387028	O-2026	Filter Head O-ring
570065	O-2090	O-ring

CARTRIDGE FILTER-PREDATOR-50, 75, 100, 150, 200 SQ. FT.		
873004	O-2375	Body O-ring
863005	G-4458	Drain Cap Gasket
391028	O-2165	Union O-ring

CARTRIDGE FILTER-QUANTUM STAINLESS STEEL-175, 350 SQ. FT.		
510136	G-4278	Bulkhead Gask-Thick
510137	G-4237	Bulkhead Gasket
530088	O-1143	18" O-ring (Aft 11/94)
850057	O-2231	O-ring
<i>O-ring/Gasket Kit Available...See pg. 76.</i>		

CARTRIDGE FILTER-QUANTUM COMPOSITE-175, 350, 500 SQ. FT.		
590210	O-1142	O-ring
510137	G-4237	Bulkhead Gasket
510136	G-4278	Bulkhead Gasket
850057	O-2231	O-ring

Please Note: Parts listed by Manufacturer number start on page 14.

FITS OEM#	SSC#	DESCRIPTION
CARTRIDGE FILTER-QUANTUM-RPM-350, 500 SQ. FT.		
390102	O-1141	Clamp O-ring
391029	O-2040	Bulkhead O-ring
850057	O-2231	Drain Plug O-ring

D.E. FILTER-SPIN		
510031	O-2024	Shaft O-ring
530004	G-4298	Flat Gasket
530018	O-2402	Quad Ring
530028	O-1039	18" Tank O-ring

D.E. FILTER-TITAN STAINLESS STEEL-24, 36, 48, 60, 72 SQ. FT.		
510135	O-2106	O-ring (Before 1990)
510136	G-4278	Bulkhead Gasket
510137	G-4237	Bulkhead Gasket
530028	O-1039	18" Tank O-ring (Before 11-94)
391029	O-2040	O-ring (After 1990)
850057	O-2231	O-ring
510133	G-4371	Bulkhead Gasket
530088	O-1143	18" Tank O-ring (After 11-94)
510035	O-2106	Outlet O-ring
<i>O-ring/Gasket Kit Available...See pg. 76.</i>		

D.E. FILTER-TITAN COMPOSITE MATERIAL-24, 36, 48, 60, 72 SQ. FT.		
590210	O-1142	O-ring
510137	G-4237	Bulkhead Gasket
470642	O-2082	Lid Fitting O-ring
510136	G-4278	Bulkhead Gasket
391029	O-2040	Bulkhead O-ring

D.E. FILTER-TITAN RPM-350, 500 SQ. FT.		
390102	O-1141	Tank Clean O-ring
391029	O-2040	Bulkhead O-ring
850057	O-2231	Drain Plug O-ring

D.E. FILTER-WARRIOR AUTOMATIC REGENERATION FILTER		
873004	O-2375	Body O-ring
863005	G-4458	Drain Cap Gasket
391028	O-2165	Union O-ring

SAND FILTER-ECLIPSE AND METEOR TM-18", 20", 22", 26", 30"		
510116	O-2054	Valve O-ring-Eclipse
510119	O-2224	Standpipe O-ring
863005	G-4458	Drain Cap Gasket
510050	O-2068	Drain O-ring

SAND FILTER-ECLIPSE SM-26", 30", 36"		
520005	O-2054	Top O-ring
570068	O-2239	O-ring
510050	O-2068	Drain O-ring

SAND FILTER-OLYMPIAN FIBERGLASS		
392003	O-2095	Lid O-ring
392041	O-2060	Lid O-ring-TM Series
510035	O-2106	Union O-ring
510136	G-4278	Bulkhead Gask-Thick
510137	G-4237	Bulkhead Gasket
<i>O-ring/Gasket Kit Available...See pg. 76.</i>		

EQUIPMENT CROSS REFERENCE

FITS OEM# SSC# DESCRIPTION

SAND FILTER-OLYMPIAN SIDE MOUNT-FIBERGLASS

392003	O-2095	Lid O-ring
510137	G-4237	Bulkhead Gasket
590006	O-2106	Bulkhead O-ring
391029	O-2040	Bulkhead O-ring
510136	G-4278	Thin Gasket

SAND FILTER-SANDPIPER S.S.-18", 24"

510135	O-2106	O-ring-18", 24"
510136	G-4278	Bulkhd Gask-18",24"
510137	G-4237	Bulkhd Gask-18",24"
530028	O-1039	18" Tank O-ring
550009	G-4311	Hub Gask-18",24",30"
550017	O-1042	24" Tank O-ring
550067	O-2239	Drain O-ring-30"
391029	O-2040	O-ring-Current Version
530088	O-1143	18" Tank O-ring (After 11-94)
850057	O-2231	Drain Plug O-ring

1 1/2" MULTIPOINT VALVE-SIDE MOUNT-501501, 501601

510010	O-2410	Lid Quad Ring
510012	O-2133	Shaft O-ring
510013	G-5146	Back Up Ring-Teflon
510018	G-4300	Sight Glass Gasket (For Kit Order 2)
510084	G-5104	Spider Gask (Bef. '76)
--	G-5105	Spider Gask (Aft. '76)

Repair/Service Kit Available...See pg. 76.

2" MULTIPOINT VALVE-P SERIES, SIDE MOUNT

982207	O-2256	Shaft O-ring (2)
982214	G-4625	Sight Glass Gasket

MULTIPOINT VALVE-5 & 8 POSITION TOP MOUNT CLAMP-ON

501517	O-2211	Lid O-ring
501519	O-2256	Rotor O-ring (2)
501523	O-2378	Backwash Sight Glass O-ring
520005	O-2054	26, 30" Sand Filter O-r

MULTIPOINT VALVE-6 POSITION TOP MOUNT CLAMP-ON

510022	O-2025	1 1/2" Valve Lid O-rg
510023	O-2374	2" Valve Lid O-ring
510026	O-2256	Rotor O-ring
510054	G-4319	Sight Glass Gasket
510058	O-2189	1 1/2" Valve Standpipe O-ring
510119	O-2224	22" Filter O-ring
520005	O-2054	26 & 30" Filter O-ring

1 1/2" & 2" SLIDE VALVE-PUSH PULL-ABS 2"

510049	G-3148	Valve Cap Gasket
510135	O-2106	Valve Cap Body O-rg
510031	O-2024	Stem & Shaft Cap O-r
510034	O-2115	Valve Cap O-ring
510050	O-2068	Valve Piston O-ring
467150	O-2126	Valve Stem O-ring
510104	O-2142	Old Style Valve Piston O-ring

Repair/Service Kit Available...See pg. 76.

FITS OEM# SSC# DESCRIPTION

2" SIDE MOUNT VALVE-M SERIES

510167	O-2297	Lid O-ring
510177	O-2256	O-ring (2)
510173	G-4394	Gasket

5 & 8 POSITION TOP MOUNT VALVE-1 1/2"-501151, 501181, 501182, 501183

501517	O-2211	Lid O-ring
501519	O-2256	Rotor O-ring

6 POSITION TOP MOUNT VALVE-1 1/2" & 2"-501131, 501130, 501231

510022	O-2025	1 1/2" O-ring
510023	O-2374	2" O-ring
510026	O-2256	O-ring

SKIMMERS

451170	G-4002	Sealing Gasket-Twin Port Spa
570082	O-2226	Equalizer O-ring-S20 Admiral
850016	G-4008	Sealing Liner Rubber Gasket-Admiral
850016	G-3034	Sealing Liner Fiber Gasket-Admiral
850033	G-3011	Rear Sealing Gasket-FAS 100
850034	G-3009	Front Sealing Gasket-FAS 100
850077	G-3008	Wide Throat Sealing Gasket-Admiral
850151	O-2224	Bottom O-ring-S20 Admiral

ANTHONY

AJ-104-1, AJ-105-1 & AJ-106-1 SERIES PUMPS

4547	MS-100	Pump Seal
4465	G-3226	A.J. Gasket

AS-1, AS-2, AC-1, AC-2 PUMPS

4380	MS-1000	Pump Seal
4382	G-3253	Volute Gasket

1 1/2" SELECTOR VALVE

17437	O-2024	Small O-ring
17606	O-2142	Cap O-ring
17791	O-2004	Plastic Saddle O-rg (2)
17606	O-2142	Brass Saddle O-rg (2)

2" SELECTOR VALVE

17437	O-2024	Small O-ring
17681	O-2231	Cap O-ring
17792	O-2188	Plastic Saddle O-rg (2)
17681	O-2231	Brass Saddle O-rg (2)

2" PLASTIC SLIDE VALVE

--	O-2008	Piston O-ring (3)
17437	O-2024	Shaft O-ring (3)
17790	O-2106	Bulkhead Connector O-ring (2)

Repair/Service Kit Available...See pg. 73.

1 1/2" BRASS SLIDE VALVE

17606	O-2142	Piston O-ring (3)
17437	O-2024	Shaft O-ring (1)

Repair/Service Kit Available...See pg. 73.

FITS OEM# SSC# DESCRIPTION

AQUA FLO

A SERIES PUMP

91500050	G-3256	Volute Gask-.33-2HP
91500100	G-3220	Volute Gasket-3 HP
91500250	G-4407	100% Drain Gasket
92200000	O-2228	5" Trap Cover O-ring
92200010	O-2247	6" Trap Cover O-ring
92500050	MS-1000	Pump Seal
AF12	G-3275	Trap Gasket

Repair/Service Kit Available...See pg. 73.

AC SERIES PUMP

91500000	G-3151	Volute Gasket
91500200	G-3240	6" and 8" Trap Gask.
92200010	O-2247	6" Trap Cover O-ring

B SERIES PUMP

91500050	G-3256	Volute Gask-.33-2 HP
91500250	G-4407	100% Drain Trap Gsk
92200100	O-2226	O-ring
92500050	MS-1000	Pump Seal

C SERIES PUMP

92200100	O-2226	O-ring
92200060	O-2141	O-ring
92200140	O-2195	O-ring
92200050	O-2067	Volute O-ring
92500050	MS-1000	Pump Seal

DOMINATOR PUMP

92200140	O-2195	O-ring
92200180	O-1082	Seal Plate O-ring
92200100	O-2226	Suction O-ring
92200060	O-2141	O-ring
92200190	O-2128	Cover O-ring
92200210	O-2270	Bulkhead O-ring
92500050	MS-1000	Pump Seal (Pre-'95)
--	MS-200	Pump Seal (Since '95)

Repair/Service Kit Available...See pg. 73.

FLO MASTER PUMP-FMCP, FMHP & TMCP

91049000	MS-2131	Pump Seal
92200000	O-2228	Trap Cover O-ring
92200090	O-2262	Volute O-ring
92200100	O-2226	Suction Flange O-ring
92200120	O-2253	Pipe Plug O-ring
92200140	O-2195	Fitting O-ring
92200200	O-2025	Volute O-ring
92200060	O-2141	Plug O-ring

Repair/Service Kit Available...See pg. 73.

FLO MASTER PUMP-XP

92200290	O-2214	Volute O-ring
92200060	O-2141	Drain Plug O-ring
92200210	O-2270	O-ring

FLO MASTER-FMVP

91049000	MS-2131	Pump Seal
92200090	O-2262	Volute O-ring
92200120	O-2253	Drain Plug O-ring
92200100	O-2226	O-ring
92200140	O-2195	O-ring
92200200	O-2025	Volute O-ring

EQUIPMENT CROSS REFERENCE

FITS			FITS			FITS		
OEM#	SSC#	DESCRIPTION	OEM#	SSC#	DESCRIPTION	OEM#	SSC#	DESCRIPTION
TUB MASTER PUMP			CARETAKER			HAYWARD		
91049000	MS-2131	Pump Seal	HYDROSTORM PUMP			SPX1250XZ2	MS-200	Pump Seal
92200090	O-2262	Volute O-ring	413-0501	O-2165	Mounting Bracket O-rg	SPX1600R	O-2618	Gasket
92200140	O-2195	Fitting O-ring	413-0575	O-2146	Diffuser O-ring	SPX1600Z2	MS-200	Pump Seal
92200200	O-2025	Volute O-ring	413-0620	O-2224	Lid O-ring	SPX125Z3	G-5003	Diffuser Gasket
ARNESON			DIACLEAR			SPX125T	G-5039	Strainer Cover Gask
POOLSWEEP			SAND FILTER-MS-12, 16 & SS-18			SPX145T	G-5009	Strainer Cover Gask
F-7	O-2082	O-ring	C10146	O-2201	O-ring	CAST IRON PUMP (DISCONTINUED)		
G-29B	G-3237	Gear Housing Gasket	C30082	O-2099	Strainer Cover O-ring	SPX0125F	G-4227	Slinger Gasket
F-24	O-2135	O-ring	DOUGHBOY			SPX0125T	G-5039	Lid O-ring
G-12	O-2208	O-ring	POWER PAK I PUMP			SPX0125Z2	MS-372	Pump Seal (Prior '67)
G-32	O-2263	O-ring	308-1059	O-2119	Lid O-ring	SPX0125Z3	G-5003	Diffuser Gasket
A-08A	MS-200	Pump Seal	306-1002	MS-1000	Pump Seal	SPX1250G	G-3128	Bracket Gasket
ASTRAL			308-1061	O-2203	Basket Port O-ring	SPX1250XZ2	MS-200	Pump Seal (After '67)
ASTRA MAX PUMP-ABOVE GROUND			<i>Repair/Service Kit Available...See pg. 73.</i>			<i>Repair/Service Kit Available...See pg. 73.</i>		
7731329035	O-2025	O-ring	POWER PAK II PUMP			MAX FLO PUMP		
7730599035	O-2226	O-ring	--	MS-2131	Pump Seal	SPX0125Z2	G-5039	Strainer Cover Gasket
7731520035	O-2011	O-ring	309-1003	O-2104	Seal Housing	SPX0145G	O-2618	Diffuser O-ring/Gask
15628R9601	MS-1000	Pump Seal	<i>Repair/Service Kit Available...See pg. 73.</i>			SPX0145T	O-1209	Housing O-ring/Gask
BAKER HYDRO			HARMSCO			SPX1250XZ2	MS-201	Pump Seal
SAND FILTER-HRV-SIDE MOUNT 1969-84			CARTRIDGE FILTERS-STAINLESS STEEL-BF42, 84, 126			<i>Repair/Service Kit Available...See pg. 73.</i>		
00B7001	O-2106	Bulkhead Fitting	550	O-1207	Rim Gasket	NORTHSTAR PUMP		
		O-ring-Old Style	551	O-2188	O-ring	SX0360Z1	O-2355	Diffuser O-ring
00B7013	G-5006	Lid Gasket-New Style	552	O-2200	O-ring	CX0400G	O-2307	Strainer Cover O-ring
00B7027	O-2040	Bulkhead Union O-ring	CARTRIDGE FILTERS-STAINLESS STEEL-BF96, 144			SPX1600Z2	MS-201	Pump Seal
15B0069	G-5127	172 Lid Gask-Old Sty.	550	O-1207	Rim Gasket	SPX4000TS	O-2307	Strainer Cover O-ring
31B9006	G-4271	Bulkhead Fitting	930	O-2002	O-ring	SPX4000T	O-2047	Seal Plate O-ring
		Gasket-Old Style	552	O-2200	O-ring	SPX4000Z1	O-2355	Diffuser O-ring
SAND FILTER-BAKER HYDRO II TOP			CARTRIDGE FILTER-BF168, 252, 336			<i>Repair/Service Kit Available...See pg. 74.</i>		
MOUNT-18", 24", 30"			635	G-4402	Top Rubber Seal	POWER FLO PUMP 1500 SERIES-SP-1500, 1510, 1511, 1550, 1575, 1500UN		
00B7031	G-5011	Valve Adapter O-ring	<i>(168 & 252)</i>			SPX710Z3	O-2025	Strainer Cover O-ring
00B7000	O-1210	O-ring	636	G-4403	Top Rubber Seal (336)	<i>(Old Sty-Blue Cover)</i>		
1 1/2" HRV & TM MULTIPOINT VALVE			639	G-4334	Bottom Seal	SPX1500KA	MS-2131	Pump Seal
30C3005	O-2025	Cover O-ring	CARTRIDGE FILTER-BF450, BF600, BF900FL, BF1200FL			SPX1500H	G-3125	Housing Gask-Fiber
30C3009	O-2256	Shaft O-ring	671	G-4404	Top Rubber Seal	SPX1500H	G-4119	Housing Gask-Rubber
30C3011	G-5106	Spider Gasket	<i>(450 & 600)</i>			SPX1500W	O-2152	Strainer O-ring
30C3015	G-4637	Sight Glass Gasket	639	G-4334	Bottom Seal	SPX1500P	O-2007	Strainer Cover O-ring
30C3019	O-2195	Plug O-ring	CARTRIDGE FILTER-BF50, 75, 100, 150			SPX1495Z1	O-2040	End Connector O-ring
30C3018	O-2195	Center Tube O-ring	783	O-2165	2 1/2" O-ring	SPX1250RA	BA-692	Basket
		(TM Only)	784	O-2189	2 1/8" O-ring	<i>Repair/Service Kit Available...See pg. 73.</i>		
2" HRV & TM MULTIPOINT VALVE			CARTRIDGE FILTERS-STAINLESS STEEL-TF50, 75, 100, 150			POWER FLO PUMP-SP1580, 1580X15, 1520UN		
30C3105	O-2374	Cover O-ring	783	O-2165	2 1/2" O-ring	SPX1580Z1	O-2209	Housing O-ring
30C3109	O-2256	Shaft O-ring	784	O-2189	2 1/8" O-ring	SPX1495Z1	O-2040	End Connector O-ring
30C3115	G-4637	Sight Glass Gasket	CARTRIDGE FILTERS-STAINLESS STEEL-TF50, 75, 100, 150			POWER FLO II & III 1700-SP-1705, 1710, 1711, 1720, 1725, 1750, 1778, 1780		
30C3119	O-2165	Plug O-ring	783	O-2165	2 1/2" O-ring	SPX1500-KA	MS-2131	Pump Seal
SLIDE VALVE			784	O-2189	2 1/8" O-ring	SPX1705Z1	O-2143	Housing O-ring
00B7014	O-2188	Piston O-ring	CARTRIDGE FILTERS-STAINLESS STEEL-TF50, 75, 100, 150			SPX710Z3	O-2025	O-ring
31B0035	O-2082	O-ring	783	O-2165	2 1/2" O-ring	SPX1500W	O-2152	Strainer O-ring
31B0015	G-4268	Top Plate Gasket	784	O-2189	2 1/8" O-ring	POWER FLO PUMP II & III-SP-1700 UN SERIES		
00B7027	O-2040	O-ring	CARTRIDGE FILTERS-STAINLESS STEEL-TF50, 75, 100, 150			SPX1705Z1	O-2143	Housing O-ring
31B0077	K-6006	Piston O-ring Kit	783	O-2165	2 1/2" O-ring	SPX1495Z1	O-2040	Union O-ring
SKIMMER			784	O-2189	2 1/8" O-ring	POWER FLO PUMP II & III-SP-1700 UN SERIES		
51B1047	G-3010	Face Frame Gasket-All Models	CARTRIDGE FILTERS-STAINLESS STEEL-TF50, 75, 100, 150			POWER FLO PUMP II & III-SP-1700 UN SERIES		

EQUIPMENT CROSS REFERENCE

FITS OEM# SSC# DESCRIPTION

POWER FLO LX PUMP-SP1580 SERIES
 SPX1500KA MS-2131 Pump Seal
 SPX1580Z1 O-2209 Housing O-ring
 SPX1250RA BA-692 Basket
 SPX1500P O-2007 Strainer Cover O-ring
 SPX1500W O-2152 Strainer O-ring
Repair/Service Kit Available...See pg. 74.

POWER FLO MATRIX PUMP-SP1590 SERIES
 SPX5500H O-2286 Strainer COver O-ring
 SPX5500K O-2100 Strainer O-ring
 SPX710XZ5 O-2128 Housing O-ring
 SPX1250XZ2C MS-200 Pump Seal

POWER FLO PUMP-SP-1900SD BATH
 SPX1905E O-2185 Housing O-ring
 SPX1500KA MS-2131 Pump Seal
 SPX1495Z1 O-2040 End Connector O-ring

SUPER II PUMP
 SPX1600R O-2618 Diffuser Gasket
 SPX1600Z2 MS-201 Pump Seal
 SPX3000S O-2247 Cover O-ring
 SPX3000T O-1217 Housing O-ring/Gask
Repair/Service Kit Available...See pg. 74.

SUPER PUMP
 SPX1600R O-2618 Diffuser Gasket
 SPX1600S O-1226 Strainer Cvr O-rng/Gsk
 SPX1600T O-1209 Housing Gasket
 SPX1600Z2 MS-201 Pump Seal
 SPX1600M BA-693 Basket
Repair/Service Kit Available...See pg. 74.

TURBO FLO PUMP-SP2075, 2175
 SPX1500KA MS-2131 Seal Assembly
 SPX1500H G-3125 Housing Gasket
 SPX1705Z1 O-2143 Housing O-ring
 (SP-2100 Series)

CARTRIDGE FILTER-ASL-C850, C1250
 RGX0045G O-1144 Filter Head O-ring
 SPX1425Z6 O-2195 O-ring

CARTRIDGE FILTER-EASY CLEAR A.G.-C-400, 550
 CX0400G O-2307 Cover O-ring
 SX0200Z8 G-4325 Drain Cap Gasket

CARTRIDGE FILTER-MICRO STAR CLEAR
 CX0120D O-2095 Lid O-ring
 SPX1485C G-5033 Gasket/O-ring
O-ring/Gasket Kit Available...See pg. 76.

CARTRIDGE FILTER-SKIM FILTER-SF-400, SF-400-90
 SPX1500M O-2104 Small Drain Valve
 O-ring (Lower)
 SX0200Z9 G-4325 Drain Cap Gasket
 SPX1084B G-3020 12-Hole Skimmr Gask
 SPX1090E G-3006 10 Hole Skimmr Gask
 SPX1084Z4A SCR-410 Skimmer Screw

FITS OEM# SSC# DESCRIPTION

CARTRIDGE FILTER-STAR CLEAR-C-250, 500, 750
 CX0250F O-1215 Tank O-ring
 CX0250Z7 O-2116 Locking O-ring
 SPX0605Z2 O-2261 Drain Plug O-ring
 (1980-Present)
 SP1082Z410 O-2090 O-ring
O-ring/Gasket Kit Available...See pg. 76.

CARTRIDGE FILTER-STAR CLEAR II-C-800, 1100, 1500
 CX0250Z7 O-2116 Locking O-ring
 CX0800F O-1054 Lid O-ring
 SPX0605Z2 O-2261 Drain Plug O-ring
O-ring/Gasket Kit Available...See pg. 76.

CARTRIDGE FILTER-STAR CLEAR PLUS-C-751, 900, 1200, 1750Z
 CX0900H O-2239 O-ring
 CX0900F O-2306 Filter Head O-ring
 SPX0605Z2 O-2261 O-ring

CARTRIDGE FILTER-SUPER STAR CLEAR-MOLDED-C-2000, C-3000, C-4000
 SX0200Z5 O-2133 Filter O-ring
 SX0200Z3 O-2270 Filter O-ring (Pre '95)
 SX0200Z4 O-2165 Filter O-ring
 DEX2400K O-1001 Tank O-ring
 DEX2400Z3A O-2253 Relief Valve Stem O-r
 DEX0360M O-2199 O-ring
O-ring/Gasket Kit Available...See pg. 76.

CARTRIDGE FILTER-SUPER STAR CLEAR-STAINLESS STEEL-C-3000S, C-4000S
 SPX1495Z1 O-2040 Base O-ring
 SPX0722G O-2155 Inlet Elbow O-ring
 SPX0072Z4 O-2208 Air Relief Valve Stem
 O-ring
 DEX0360K O-1099 Tank O-ring
 DEX2400Z3A O-2253 Air Relief Valve Stem
 O-ring
 DEX2400S5 G-4212 Gasket
 DEX0360E O-2186 O-ring
 DEX0360M O-2199 Bulkhead O-ring
 SX0200Z3 O-2270 Bulkhd O-rng (Pre '92)
 SX0200Z4 O-2165 O-ring
O-ring/Gasket Kit Available...See pg. 76.

CARTRIDGE FILTER-SWIMCLEAR
 ECX27091 103009PL Pressure Gauge
 DEX2400K O-1001 Tank O-ring
 DEX360M O-2199 O-ring
 SPX1022C WP-20 Drain Plug w/ O-ring

CARTRIDGE FILTER-XSTREAM
 ECX27091 103009PL Pressure Gauge
 SPX1022C WP-20 Drain Plug O-ring
 CCX1000G O-2395 Body O-ring
 SPX1500W O-2152 Pressure Gauge O-rng
 CCX1000Z5 K-6023 Air Relief Valve O-ring

FITS OEM# SSC# DESCRIPTION

D.E. FILTER-MICRO CLEAR VERTICAL GRID DE-2400-6000
 DEX2400K O-1001 Tank O-ring
 DEX2400Z5 O-2106 Outlet Elbow O-ring
 DEX2400Z3A O-2253 Relief Valve Stem O-r
 ECX1287 O-2105 Outlet Elbow O-ring
 SX0200Z3 O-2270 O-ring
 SX0200Z4 O-2165 O-ring
 SX0200Z5 O-2133 Relief Valve O-ring
 SPX1485C G-5033 Gasket (Prior 1986)
 SX0360Z1 O-2355 Permaglas Body O-rng

D.E. FILTER-MICRO CLEAR VERTICAL GRID DE-7200
 DEX0360E O-2186 O-ring
 DEX0360K O-1099 Tank O-ring
 DEX0360M O-2199 Small O-ring
 DEX2400S5 G-4212 Relief Valve-Tank O-rng
 DEX2400Z5 O-2106 Outlet Elbow O-ring
 ECX1287 O-2105 Gauge Adapter O-ring
 SX0200Z3 O-2270 Large O-ring
 SX0200Z4 O-2165 O-ring
 DEX2400Z3A O-2253 Relief Valve Stem O-r
 SPX1495Z1 O-2040 O-ring

D.E. FILTER-PERFLEX EC-30, 40, 50
 ECX1287 O-2105 Gauge Adapter O-ring
 ECX9611246 O-2135 Shaft O-ring
 ECX1003 G-5153 Diaphragm Gasket
O-ring/Gasket Kit Available... See pg. 76.

D.E. FILTER-PERFLEX EC-60 SERIES II
 ECX9611246 O-2135 Shaft O-ring
 SPX1425Z6 O-2195 Inlet Fitting O-ring

D.E. FILTER-PERFLEX EC-65, EC-75
 ECX1287 O-2105 Adapter O-ring
 ECX9611246 O-2135 Shaft O-ring
 SPX1425Z6 O-2195 Inlet Fitting O-ring
 (Prior to 1989)
 SPX1500W O-2152 O-ring (1990 on)
 ECX1105 G-5152 Diaphragm Gasket
O-ring/Gasket Kit Available...See pg. 76.

D.E. FILTER-PRO GRID VERTICAL GRID
 ECX27091 103009PL Pressure Gauge
 DEX2420Z8A K-6020 O-ring (2)
 DEX2400K O-1001 Tank O-ring
 DEX2400Z5 O-2106 Outlet Elbow O-ring
 SPX1022C WP-20 Drain Plug w/ O-ring
 SX200Z4 O-2165 O-ring

D.E. FILTER-REGEN-X RG-450, 700
 RGX0045G O-1144 Filter Head O-ring
 SP1082Z410 O-2090 Piston O-ring

SAND FILTER-E-100, E-200, E-250 & SAND MASTER-SM1700T, SM1900T, SM2300T
 GMX600F O-2058 Valve/Tank O-ring
 SX0180G G-4443 Gasket

SAND FILTER-S-140T, 144T, 164T, 166T
 GMX0400F O-2164 Valve/Tank O-ring-
 S-140T
 GMX0600F O-2058 Valve/Tank O-ring-
 144, 164, 166
 SX0180G G-4443 Gasket
 SX0200Z5 O-2133 Air Valve O-ring
O-ring/Gasket Kit Available...See pg. 76.

EQUIPMENT CROSS REFERENCE

FITS	FITS	FITS
OEM# SSC# DESCRIPTION	OEM# SSC# DESCRIPTION	OEM# SSC# DESCRIPTION
SAND FILTER-S-200, S-240		
SX0240Z1 O-1044 Tank O-ring	SX0200Z5 O-2133 O-ring	DIAL-A FLO VALVE-SP-732, 733
SX0200Z3 O-2270 O-ring	SX0180G G-4443 Drain Cap Gasket	SPX733Z1A O-2242 Key O-ring
SX0200Z4 O-2165 O-ring	SX0200Z4 O-2165 Valve O-ring	BALL VALVE-SP-720, 730, 735
SX0200Z5 O-2133 Drain Pipe O-ring (Prior 1980)	DEX2400Z3A O-2253 Relief Valve Stem O-r	SPX735G O-2256 Stem O-ring
SX0200Z6 O-2091 Lid O-ring	SX0220Z3 O-2282 O-ring (S-311 '95 & Prior)	SPX735H O-2280 End Connector O-ring
SX0200Z7 O-1106 Tank O-ring	SX0360Z1 O-2355 O-ring S-311, S-360 (After '95)	BALL VALVE-SP-722, 723 AND UN 1 1/2" TRIMLINE
SX0200Z9 G-4325 Drain Gasket	MULTIPORT VALVE-1 1/2" VARI-FLO-4 POSTION-SP-704	SPX722H O-2124 Stem O-ring
SX0200Z14 O-2261 Drain Pipe O-ring (After 1980)	SPX710Z16 G-3277 Non Metallic Bearing	SPX722G O-2155 End Connector O-ring
SPX1425Z6 O-2195 Inlet Fitting O-ring	SPX704F O-2128 Cover O-ring	SPX1495Z1 O-2040 Flush Union End O-rg
SPX1485C G-5033 Elbow Gasket	MULTIPORT VALVE-1 1/2"-SP-710, 711, 712-1976 AND ON	BALL VALVE-SP-729-1 1/2" 2 WAY
<i>O-ring/Gasket Kit Available...See pg. 76.</i>	SPX710R G-4280 Sight Glass Gasket	SPX728H O-2243 End Connector O-ring
SAND FILTER-S-160T	SPX710XD G-5106 Spider Gasket	SPX1441Z1 O-2141 Stem O-ring
SX0160Z1 O-1049 Tank O-ring	SPX710Z3 O-2025 Cover O-ring	BALL VALVE-SP-724, 725, 726, 2" TRIMLINE
SX0200Z5 O-2133 O-ring	SPX170GA K-6001 Valve Stem O-ring Kit	SPX735G O-2256 Stem O-ring
SX0200Z6 O-2091 Lid O-ring	SPX710XZ3 O-2128 Cover O-ring	SPX724G O-2117 End Connector O-ring
SX0200Z9 G-4325 Drain Gasket	SPX710XZ3 O-2128 Cover O-ring	SKIMMERS
SX0200Z14 O-2261 O-ring	SPX735G O-2256 Valve Stem O-ring	SPX1097E G-3003 Gasket-SP-1096, 1097, 1098
<i>O-ring/Gasket Kit Available...See pg. 76.</i>	SPX1022CZ2 O-2115 O-ring	SPX1070Z1 O-2122 Float Valve Ass'y O-ring-SP-1070
SAND FILTER-PRO SERIES-S164T/S166T	MULTIPORT VALVE-1 1/2"-SP-710, 1969-75	SPX1084B G-3020 Gasket-SP-1089, 1084, 1076
ECX270861 103015PL Pressure Gauge	SPX0603Z2 O-2133 Stem O-ring w/Teflon Seal	SPX1084B G-4065 1084 Gasket-Rubber
GMX600F O-2058 Tank O-ring	SPX0710D G-5108 Spider Gasket	SPX1084L SF-451 1084 Faceplate
SAND FILTER-S-210T, S-180T, S-244T, S-220T	SPX0710Z3 O-2025 Cover O-ring	SPX1084F SF-451C Faceplate Cover
GMX0600F O-2058 Tank O-ring	SPX0710R G-4280 Sight Glass Gasket	SPX1084B3 G-3014 Gasket-SP-1084-OM
SX180G G-4443 Gasket	MULTIPORT VALVE-2"-SP-715, 716, 1976 AND ON	SPX1085D G-3001 Gasket-SP-1085,1077
SAND FILTER-S-190T, S-245T	SPX0710R G-4280 Sight Glass Gasket	SPX1085D G-4064 1085 Gasket-Rubber
GMX0600F O-2058 Tank O-ring	SPX0175Z1 O-2067 Cover O-ring	SPX1085B SF-452 1085 Faceplate
SX0200Z9 G-4325 Drain Gasket	SPX0735GA K-6001 Valve Stem O-ring Kit	SPX1085F SF-452C Faceplate Cover
SX0200Z14 O-2261 O-ring	SPX0735G O-2256 Valve Stem O-ring	SPX1090E G-3006 Gask-1090,1092-Fiber
ECX270861 103015PL Pressure Gauge	MULTIPORT VALVE-2"-SP-740DE	SPX1090E G-4001 Gasket-SP-1090, 1092-Rubber
<i>O-ring/Gasket Kit Available...See pg. 76.</i>	SPX0715Z1 O-2067 Cover O-ring	SPX1090D SF-450 1090 Faceplate
SAND FILTER-S-300T, S-310T	SX0200Z4 O-2165 O-ring	SPX1090WMSG G-4066 Widemouth A/G Gasket
GMX0600F O-2058 Tank O-ring	MULTIPORT VALVE-VARIFLO XL 1.5"	SPX1094G G-3002 Gasket-SP-1094, 1094H, SPA
SX0180G G-4443 Gasket	SPX0735GA K-6001 Shaft Seal O-ring Kit	SPX1097E G-3003 1097 Gasket-Fiber
SAND FILTER-S-210S, S-244S, S-220S, S-310S	MULTIPORT VALVE-FLANGE-1 1/2" SP-704	SPX1097E G-4067 1097 Gasket-Rubber
DEX0360M O-2199 O-ring	SPX0704F O-2128 Cover O-ring	SPX1096CA BA-690 Basket for 1090
GMX0600F O-2058 Tank O-ring	MULTIPORT VALVE-FLANGE-GM-400, 4 WAY	SPX1082CA BA-691 Basket for 1085
SX0180G G-4443 Gasket	SPX0072Z4 O-2208 Stem O-ring	SPX1082E SC-491 Skimmer Cover
SX0200Z5 O-2133 O-ring	GMX0400D G-3185 Fiber Bearing Washer	SPX1107-1 VP-695 Large Skimmer Vac Plate
SX0200Z4 O-2165 O-ring	MULTIPORT VALVE-1 1/2" FLANGED-GM-600, 6 WAY	SPX1104-1 VP-696 Small Skimmer Vac Plate
SPX1425Z6 O-2195 O-ring	GMX0600P O-2248 Stem O-ring	FEEDER-200 SERIES-CL200, CL220, CL220BR
SX220Z3 O-2282 O-ring	GMX0600D O-2144 Teflon Bearing Washer	CLX200K O-2511 Cover O-ring-Viton
SAND FILTER-GM-140, 142, 142-G, 142HV	SLIDE VALVE-2"-SP-410X	CLX200LA K-6003 O-ring Set
GMX0400F O-2164 O-ring-140, 142	ECX9611246 O-2135 O-ring	<i>Repair/Service Kit Available...See pg. 74.</i>
GMX0600F O-2058 O-ring-142-G, 142HV	SPX0722G O-2155 O-ring	FEEDER-BROMINE-C250CF, C500CF
GMX0152Z5 O-2116 O-ring	SPX0410Z2 O-2150 Large Piston O-ring	SPX3000SV O-2518 Cover O-ring-Viton
GMX142DA2 G-4462 Gasket	SPX0410Z1 O-2008 Small Piston O-ring	SPX605Z2V O-2515 Drain Plug O-rg-Viton
<i>O-ring/Gasket Kit Available...See pg. 73.</i>	SX0200Z4 O-2165 O-ring	HERCULES
SAND FILTER-GM-152, 152HV	DIVERter VALVE-PERFLEX-SP-727	SKIMMER-162010, 162025, 162050
GMX0152Z5 O-2116 Drain Plug O-ring	SPX727K O-2243 Cover O-ring	1370097 G-4055 Skimmer Gasket
GMX0600F O-2058 Tank O-ring	SPX733Z1 O-2242 Key O-ring	
GMX600FST O-1095 Valve O-ring	SPX1483C O-2231 Union O-ring	

EQUIPMENT CROSS REFERENCE

FITS OEM#	SSC#	DESCRIPTION
JACUZZI		
CYGNET PUMP-7CYG (3/4HP), ICYG (1HP), 15 CYG (1 1/2HP)M 2CYG (2HP)		
47-0352-41	O-2059	Strainer Cover O-ring
47-0112-99	O-2024	Plug O-ring
10-0002-06	MS-200	Pump Seal
47-0361-48	O-2300	O-ring
<i>Repair/Service Kit Available...See pg. 74.</i>		
DB3 COMMERCIAL PUMPS		
47-0022-09	O-2205	Sleeve O-ring
47-0165-06	O-2295	Case O-ring
J, JCM, K, KM PUMPS		
47-0357-46	O-2266	O-ring
10-0002-06	MS-200	Pump Seal
<i>Repair/Service Kit Available...See pg. 74.</i>		
L, LC, LCUN2, LT, LX, LTC, LCU, LTCU, ULCU, ULTCU, LCM PUMPS		
47-0353-40	O-2139	O-ring
47-0258-53	G-5060	Square Ring
LVL-VECTOR SERIES		
47-0352-41	O-2059	Strainer Cover O-ring
47-0258-53	G-5060	Square Ring
10-0002-06	MS-200	Pump Seal
LR, SLR SERIES PUMPS		
10-1436-00	MS-200	Pump Seal
47-0352-41	O-2059	Lid O-ring
47-0112-00	O-2024	Plug O-ring
47-0258-53	G-5060	Bracket to Case O-ring
<i>Repair/Service Kit Available...See pg. 74.</i>		
MAGNUM PUMP		
10-1390-04	MS-201	Pump Seal
47-0112-00	O-2024	Plug O-ring
47-0232-54	G-5031	Differential Square Rg
47-0358-03	O-2224	Lid O-ring-After 7/89
47-0364-47	O-2058	Housing O-ring
47-0434-01	O-2080	Lid O-ring-Prior 7/89
47-0442-01	O-2094	Case O-ring
<i>Repair/Service Kit Available...See pg. 74.</i>		
P, PC, EP, UP, PH, UPH PUMPS		
10-1203-01	MS-877	Pump Seal
47-0355-48	O-2236	Sandtrap Filter Lid O-r
47-0358-03	O-2041	Lid Gasket
47-0462-06	G-5046	Differential Square Rg
47-0466-02	G-5016	Square Ring
47-0463-05	G-5035	Strainer Cover Gasket
47-0353-40	O-2139	Cover O-ring
47-0112-00	O-2024	O-ring
<i>Repair/Service Kit Available...See pg. 74.</i>		
PJM PUMP		
47-0348-06	O-2272	Cap O-ring-1 1/2" & 2"
47-0438-07	O-2247	Cap O-ring-2" & 2 1/2"
10-1203-01	MS-877	Pump Seal
13-0191-04	G-3176	Bracket Gasket-5, 7 1/2 HP
13-0314-06	G-3202	Bracket Gasket-3 HP
13-0379-08	G-4450	Flange Gasket-5, 7 1/2 HP
<i>Repair/Service Kit Available...See pg. 74.</i>		

FITS OEM#	SSC#	DESCRIPTION
R & RC PUMP		
10-1390-04	MS-201	Pump Seal
47-0112-00	O-2024	Plug O-ring
47-0358-03	O-2041	Lid O-ring (Prior 7/89)
47-0358-03	O-2224	Lid O-ring (After 7/89)
47-0462-06	G-5046	Square Ring
47-0466-02	G-5016	Square Ring
<i>Repair/Service Kit Available...See pg. 74.</i>		
ULS PUMP		
10-1203-01	MS-877	Pump Seal
13-0314-06	G-3202	Gasket
47-0357-04	O-2266	Lid O-ring-Bronze & C.I. Cover
47-0433-51	O-2266	Lid O-ring-New Lexan Cover
CARTRIDGE FILTER-CF		
13-0417-02	O-1116	Cover O-ring
47-0223-06	O-2231	Drain Plug O-ring
CARTRIDGE FILTER-CFR 50, 75, 100, 150		
47-0106-08	O-2153	O-ring
47-0380-47	O-2181	O-ring
47-0112-00	O-2024	O-ring (Prior 1993)
13-1023-06	G-4459	Gasket
<i>Repair/Service Kit Available...See pg. 76.</i>		
CARTRIDGE FILTER-CFR25 & CFT25-SPA		
47-0112-00	O-2024	Vent O-ring
47-0360-09	O-2095	Cover O-ring
47-0380-47	O-2181	Cover O-ring (75-200 Sq. Ft.)
<i>O-ring/Gasket Kit Available...See pg. 76.</i>		
CARTRIDGE FILTER-SHERLOCK-SHER80, 120		
47-0380-47	O-2181	O-ring
13-0011-02	G-3406	Plug Gasket
CARTRIDGE FILTER-SPLASH PAK A/G		
47-0360-09	O-2095	O-ring
47-0112-00	O-2024	O-ring
CARTRIDGE FILTER-SPLASH PAK CE		
47-0226-03	O-2195	Union O-ring
47-0371-06	O-2387	Body O-ring
CARTRIDGE FILTER-SPLASH PAK EF		
47-0106-08	O-2181	O-ring
47-0380-47	O-2153	O-ring
47-0222-68	O-2165	O-ring
47-0328-00	O-2008	O-ring
CARTRIDGE FILTER-TRI-CLOPS & EARTHWORKS		
47-0112-00	O-2024	Vent O-ring
47-0228-35	O-2165	Bottom O-ring
47-0212-66	O-2264	Manifold Knob O-ring
47-0569-99	O-1015	Tank O-ring
<i>O-ring/Gasket Kit Available...See pg. 77.</i>		
D.E. FILTER-AVALANCHE-AV40, 60, 80, 100		
47-0380-47	O-2181	O-ring
13-013-00	G-3407	1 1/2" Plug Gasket

FITS OEM#	SSC#	DESCRIPTION
D.E. FILTER-LANDSLIDE, D.E. SEPARATION TANK		
47-0448-05	O-2024	Drain Plug O-ring
47-0257-05	O-2143	Support O-ring
47-0380-47	O-2181	Tank & Cover O-ring
<i>O-ring/Gasket Kit Available...See pg. 77.</i>		
SAND FILTER-LASER-160L, 190L, 225L, 250L		
13-0378-09	G-5023	Gasket
47-0359-02	O-2224	Valve O-ring
47-0434-01	O-2080	O-ring
13-1022-07	G-4447	Drain Nozzle gasket
<i>O-ring/Gasket Kit Available...See pg. 77.</i>		
SAND FILTER-SAND TRAP-RMST-24, ST-24		
47-0355-06	O-2236	O-ring
47-0326-02	O-2134	Valve Adapter O-ring
SAND FILTER-SAND TRAP-ST-27, ST-33		
47-0355-06	O-2236	O-ring
47-0443-00	O-2293	O-ring
42-2927-06	O-1101	O-ring
47-0326-02	O-2134	Inspection & Drain O-r
47-0213-08	O-2221	Plug O-ring
SAND FITLER-SANDSTORM 31		
47-6172-04	O-2374	O-ring
SAND FILTER-MFM15		
13-0378-09	G-5023	Gasket
47-0112-00	O-2024	O-ring
SAND FILTER-MFM17, 20, 24		
13-0378-09	G-5023	Valve Gasket
47-0013-00	O-2248	Bottom Drain Plug O-r
<i>O-ring/Gasket Kit Available...See pg. 77.</i>		
SAND FILTER-SPLASH PAK 16", 18.5", 24"		
47-6172-04	O-2374	O-ring
1 1/2" DV-5 DIAL VALVE-PLASTIC & BRONZE MODELS FOR PM FILTERS		
47-0110-02	O-2090	O-ring
47-0117-05	O-2220	Shaft O-ring
13-0113-64	G-5023	Flange Square Ring
2" DIAL VALVE-39-2586-03		
47-0364-47	O-2058	Cover O-ring
47-0212-09	O-2256	O-ring
13-1075-03	G-4618	Gasket
47-0229-00	O-2226	O-ring
2" DV-5 DIAL VALVE-CAST IRON		
47-0110-02	O-2090	O-ring
47-0364-05	O-2058	O-ring
47-0370-07	O-2278	O-ring
47-0143-03	O-2049	O-ring
6-7 WAY DIAL VALVES-DVK-6, DVK-7, 15VK-24 & 15VK-27/33 PLASTIC VALVES		
47-0214-07	O-2264	Key Assembly O-ring
47-0258-53	G-5060	Square Ring (DVK-6)
DV-4 DIAL VALVE-FOR 15MFM FILTER		
47-0214-07	O-2064	Key Assembly O-ring
47-0248-56	G-5026	Square Ring

EQUIPMENT CROSS REFERENCE

FITS	FITS	FITS
OEM#	OEM#	OEM#
SSC#	SSC#	SSC#
DESCRIPTION	DESCRIPTION	DESCRIPTION
SKIMMERS	LETRO	CARTRIDGE FILTER-FE129
13-0411-08 G-3012 Face Gasket-WL, WC, WB Widemouth	LA01N PUMP	72209 O-2391 Filter Head Cover O-ring
47-0248-56 G-5026 Square Ring	LA1000 MS-1000 Pump Seal	CARTRIDGE FILTER-FE029-5 FOR MAGNA FLO PUMP
JANDY	LA375 O-2253 Drain Plug O-ring	54017 G-3269 Valve Gasket
MEDIUM HEAD PUMPS-MHP & MHPU UP RATED SERIES	LA415 O-2089 O-ring	54006 G-3194 Gasket (2)
R0338200 MS-601 Pump Seal	MARLOW	54021 G-3195 Gasket (2)
R0340400 O-2214 Body O-ring	AF SERIES PUMP	54007 G-3235 Gasket (2)
R0338801 O-2100 Diffuser O-ring	32540 G-5078 Strainer Cover Gasket	54027 G-4218 Tank Gasket
R0338900 O-2224 Pot Lid O-ring	15621 G-5073 Diffuser Gask-1-2 HP	CARTRIDGE FILTER-POLY ELEMENT-FE002-FE097
R0339600 O-2002 Coupling Set O-ring	21035 O-2100 Diffuser Gasket-3 HP	54006 G-3194 Closure Nut Gasket
HIGH HEAD PUMPS-HHP FULL RATED & HHPU UP RATED SERIES	253532 MS-411 Pump Seal	54067 O-2256 Pump O-ring
R0338200 MS-601 Shaft Seal	21034 G-3103 Housing Gasket	54076 G-3405 Pump Gasket
R0338700 O-2146 Body O-ring	ARGONAUT PUMP	CARTRIDGE FILTER-POLY ELEMENT-FE-095-FE121
R0338801 O-2100 Diffuser O-ring	44308 O-2167 Cover O-ring	54008 G-5001 Closure Nut Gasket
R0338900 O-2224 Pot Lid O-ring	38592 MS-201 Pump Seal	54067 O-2256 O-ring
R0339600 O-2002 Coupling Set O-ring	44802 O-2094 Seal Plate Gasket	54029 G-4613 Intake Gasket
CARTRIDGE FILTERS-C200, C300, C400, CT50, CT75, CT100, CL580	GEMINI WHIRLPOOL PUMP	CARTRIDGE FILTER-POLY PAK
R0350600 O-1160 Tank O-rng(C200-400)	40478 O-2189 O-ring	54065 O-2146 O-ring
R0353400 O-2390 Lid O-ring (CT50-100)	42925 O-2118 O-ring	54005 G-3193 Gasket
R0357800 O-1161 Tank O-ring (CL580)	H SERIES PUMP	CARTRIDGE FILTER-1/8 HP POLY ELEMENT-FE039-FE064
CARTRIDGE FILTER-SHEER DESCENT-3456	26144 G-5069 Diffuser Gasket-3/4 to 1 1/2 HP	54005 G-3193 Gasket
3293 O-2125 Filter O-ring	25475 O-2100 Diffuser Gasket-2 HP	54065 O-2146 O-ring
D.E. FILTER-DEL60	253532 MS-411 Pump Seal	CARTRIDGE FILTER-POLY ELEMENT-FE066
R0357800 O-1161 Tank O-ring	23112 G-3166 Housing Gasket	54065 O-2146 O-ring
2 & 3 PORT VALVES-NEVERLUBE & REGULAR	L SERIES STOCKLINE PUMPS	SAND FILTER-1/8 HP-FS643, FS-567
1132 O-2175 Valve Cover O-ring	P48690 G-3404 Volute Gasket	54005 G-3193 Gasket
1307 O-2220 Valve Shaft O-ring (2)	186862 BP-386 Pump Seal	54007 G-3235 Gasket
2 & 3 PORT SPACE SAVER VALVE	MARDUR PUMP	54027 G-4218 Tank Gasket
6749 O-2049 O-ring	25476 G-5017 Diffuser O-ring-1 1/2 & 2 HP	54023 G-3190 Gasket
1307 O-2220 Valve Shaft O-ring (2)	30156 O-2140 Diffuser O-rg-1/3-1 HP	54021 G-3195 Gasket
90 DEGREE VALVE	37478 G-5014 Small Str. Cover Gask	54006 G-3194 Gasket
1132 O-2175 Valve Cover O-ring	37479 G-5010 Strainer to Tank Gask	54017 G-3269 Valve Gasket
1307 O-2220 Valve Shaft O-ring (2)	37482 G-5052 Tank to Seal Plate Gasket	SAND FILTER-15" TANK-FS619, FS620, FS719, FS720, FTA11, 72902
90 DEGREE SPACE SAVER VALVE	39404 G-5016 Strainer Cover Gasket- 1 1/2-2 HP	54007 G-3235 Gasket
6749 O-2049 O-ring	38592 MS-201 Pump Seal	54023 G-3190 Gasket
1307 O-2220 Valve Shaft O-ring (2)	4SPC SERIES PUMPS	54021 G-3195 Gasket
LESLIE'S	37478 G-5014 Gasket	54006 G-3194 Gauge Adapter Gask
HYDRAMAX II-SP-LE-40010 TP SP-LE-40019	47040 G-3415 Gasket	54017 G-3269 Valve Gasket
5066-C1 O-2247 Strainer Cover O-ring	47121 G-3414 Gasket	SAND FILTER-FS369, FS739, FTA12, 72904 (15") & FS570, FS770, 72909 (18")
SPX1600-R O-2618 Diffuser Gasket	MUSKIN	54007 G-3235 Gasket
SPX1600-Z2 MS-201 Pump Seal	AQUA JET PUMP	54021 G-3195 Gasket
SPX3000-T O-1217 Housing Gasket	54005 G-3193 Gasket	54027 G-4218 Tank Gasket
HYDRAMAX A/G-ABOVE GROUND POOLS-SP-LE-40022 TO SP-LE-40026	MAGNA FLO PUMP	54023 G-3190 Gasket
SPX1500-KA MS-2131 Pump Seal	54071 O-2007 Hair & Lint Pot O-ring	54012 G-3122 Valve Gasket
SPX1705-Z1 O-2143 Housing O-ring	MPA PUMP	SAND FILTER-FS592, FS792, FTA13, 72913 (15") & FS571, FS572, FS771, FS772, FTA15, 72910 (18")
SPX710-Z-3 O-2025 O-ring	54005 G-3193 Gasket	54020 G-3191 Gasket
SPX1500-W O-2152 Strainer O-ring	CARTRIDGE FILTER-AQUAJET	54055 G-3403 Gasket
	54076 G-3405 Pump O-ring	54027 G-4218 Gasket
	54067 O-2256 Pump O-ring	
	54029 G-4613 Gasket (2)	
	54008 G-5001 Closure Nut Gasket	

EQUIPMENT CROSS REFERENCE

FITS

OEM#	SSC#	DESCRIPTION
SAND FILTER-FS583-8, FS584-8, FS585-8, FS683-8, FS684-8, FS685-8, FS783-8, FS784-8, FS785-8		
54072	O-2020	Gasket
54055	G-3403	Gasket
54027	G-4218	Tank Gasket
54067	O-2256	Small O-ring
54079	O-2128	Large O-ring

SAND FILTER-12" TANK ASSEMBLY-FS609, FTA10, 72901

54007	G-3235	Gasket
54027	G-4218	Tank Gasket
54021	G-3195	Gasket
54017	G-3269	Valve Gasket

SAND FILTER-FS683B

19-2115	O-2261	Drain Plug O-ring
15-4713	G-4640	Drain Gasket
27-2505	O-2082	Plastic Washer (2)
72201	O-2012	Valve Bottom O-ring
72198	O-2266	Valve Top O-ring

SAND FILTER-FS SERIES

54023	G-3190	Gasket
54005	G-3193	Gasket
54007	G-3235	Gasket (2)
54023	G-4218	Gasket
54021	G-3195	Gasket (2)
54072	O-2020	O-ring (Magna Flo)
54017	G-3269	Valve Gasket
54055	G-3403	Gasket (Magna Flo)
54078	O-2242	Small O-ring (2) (Magna Flo Pump)
54006	G-3194	Gasket

3 POSTION VALVE

54017	G-3269	Valve Gasket
54062	O-2133	Valve Stem O-ring

5 POSTION VALVE

54062	O-2133	Valve Rotor Stem O-rng
54012	G-3122	Valve Gasket
54040	O-2420	Quad Ring (4)

7 POSITION VALVE

54078	O-2242	Small O-ring (2)
54079	O-2128	Large O-ring

OLYMPIC

WIDE MOUTH SKIMMER

WP-83W	G-4056	Widemouth Gasket
--------	--------	------------------

FITS

PENTAIR / PAC FAB

CHALLENGER PUMP

19-2115	O-2082	Drain Plug O-ring
35-4545	MS-200	Pump Seal
35-5030	O-2409	Medium Head Diffuser O-ring
35-5329	G-5061	Front Housing Square Ring-New Style
35-5329	O-2046	Front Housing O-ring-Old Style
35-5330	O-2226	Strainer Pot Fig. O-rng
35-5331	O-2015	High Head Diff. O-r
35-5332	O-2172	Lid O-ring (Old Style)
35-5332	O-2080	Lid O-ring (New Style)
27-4494	O-2002	Union O-ring
15-2509	G-5079	Square Ring

Repair/Service Kit Available...See pg. 74.

COMMERCIAL R SERIES PUMPS-5-15 HP

07-1725	MS-360	Pump Seal
07-4629	G-4386	Gasket

DYNAMITE & DYNATRON PUMPS

35-4545	MS-200	Pump Seal
35-4533	O-2139	Housing O-ring
35-4571	O-2195	Adapter O-ring

DYNAMO & DYNAMO II PUMPS

27-3062	O-2040	Cap O-ring
35-4533	O-2139	Tank Lid O-ring (For Dynamo II)
35-4535	O-2214	Bracket Diffuser O-rng
35-4545	MS-200	Pump Seal
35-4571	O-2195	Connection O-ring (2)
35-4634	O-2286	Bracket O-ring-After 1993

Repair/Service Kit Available...See pg. 74.

HYDRO PUMP

19-2323	O-2106	Connector & Bulkhead O-ring
35-2602	O-2028	Lid O-ring
35-2626	O-2262	Volute O-ring
35-3525	O-2080	Lid O-ring (New Style)
35-4001	MS-201	Pump Seal
35-5332	O-2172	Lid O-ring (Old Style)
35-2627	G-4104	Seal Plate Gasket

Repair/Service Kit Available...See pg. 74.

PINNACLE PUMP

35-5619	O-2294	Seal Bracket O-ring
19-2115	O-2082	Drain Plug O-ring
35-4545	MS-200	Pump Seal
35-5030	O-2409	Diffuser O-ring
35-5332	O-2172	Lid O-ring
35-4571	O-2195	O-ring (After 11/1/94)

Repair/Service Kit Available...See pg. 74.

R SERIES COMMERCIAL HIGH PERFORMANCE PUMP

07-5847	O-2389	Lid O-ring
07-5848	O-2139	Diffuser O-ring
07-1725	MS-360	Pump Seal
07-4629	G-4386	Gasket

FITS

SUPERFLO PUMP

19-2115	O-2082	Drain Plug O-ring (2)
35-5619	O-2294	Valve Adapter O-ring
35-5030	O-2409	Adapter O-ring (2)
35-4545	MS-200	Pump Seal

WATERFALL PUMP

35-4545	MS-200	Pump Seal
35-5331	O-2015	Diffuser O-ring
35-5329	G-5061	Front Housing O-ring
19-2115	O-2082	Drain Plug O-ring
35-5330	O-2226	Strainer Pot Fig O-ring
19-2115	O-2082	Drain Plug O-ring
35-5332	O-2080	Lid O-ring

CARTRIDGE FILTER-CLEAN & CLEAR PLUS-POLYPROPYLENE-240, 320, 420, & 520 SQ. FT. MODELS

39010200	O-1141	Clamp O-ring
86006900	O-2150	Lower Bulkhead O-r
86300500	G-4458	Drain Cap Gasket
51005000	O-2068	Drain Plug O-ring
192320	O-2215	Upper Bulkhead O-r
86006900	O-2150	Upper Bulkhead O-r

CARTRIDGE FILTER-MITRA-MA 60, 80, 100, 160

15-4661	O-2141	Air Bleeder Adapter O-ring
15-4492	O-2282	2" Bulkhead O-ring
15-4538	G-4324	Bulkhead Diffuser Gasket
27-4494	O-2002	Bulkhead Adapter O-r
31-3225	O-1070	11" Tank O-ring
15-4693	O-2376	Knob O-ring

O-ring/Gasket Kit Available...See pg. 77.

CARTRIDGE-MYTILUS FMY 80/100/150 & 60/80/100 PLASTIC

15-4492	O-2282	2" Bulkhead O-ring
15-4538	G-4324	Bulkhead Diff. Gask.
15-4661	O-2141	Air Bleeder Adapt O-r
17-4704	O-1048	Tank O-ring
27-4494	O-2002	Bulkhead Adapter O-r
15-4693	O-2376	Knob O-ring

O-ring/Gasket Kit Available...See pg. 77.

CARTRIDGE FILTER-MYTILUS B SINGLE CARTRIDGE

15-4661	O-2141	Air Bleeder Adapt O-r
17-4704	O-1048	Tank O-ring
19-1424	O-2071	Bottom Piping O-ring
19-1474	O-2115	O-ring

O-ring/Gasket Kit Available...See pg. 77.

CARTRIDGE FILTER-SEA HORSE-STAINLESS STEEL-SH 300, SH 400, SH 500

15-2127	O-1062	Tank O-ring
15-4492	O-2282	2" Bulkhead O-ring
15-4493	O-2041	6" Adapter O-ring-Fiberglass
19-2320	O-2215	Bulkhead O-ring
27-4494	O-2002	O-ring
27-3513	O-2302	Bleeder O-ring
19-2323	O-2106	O-ring

EQUIPMENT CROSS REFERENCE

FITS	FITS	FITS	
OEM# SSC# DESCRIPTION	OEM# SSC# DESCRIPTION	OEM# SSC# DESCRIPTION	
CARTRIDGE FILTER-SEA HORSE-FIBERGLASS-FSH 300, FSH 400, FSH 500			
15-4492 O-2282 2" Bulkhead O-ring	19-2115 O-2082 Drain Plug O-ring	1 1/2" BACKWASH VALVE-BRASS	
15-4661 O-2141 Air Bleeder & Adapter O-ring	27-2708 O-2059 Valve Body O-ring	27-3097 G-3271 Cap Gasket	
19-2320 O-2215 Bulkhead O-ring	SAND FILTER-TAGLEUS		
19-2323 O-2106 O-ring	15-4493 O-2041 Valve Body O-ring	27-3060 O-2090 Shaft O-ring	
27-4494 O-2002 O-ring	15-5064 O-2189 Standpipe O-ring	27-3160 G-5112 Piston O-ring (2)	
27-3513 O-2302 Bleeder O-ring	19-2115 O-2082 Drain Plug O-ring	2" BACKWASH VALVE-BRASS	
19-5008 O-1037 Tank O-ring	27-2708 O-2059 Valve Body O-ring	27-3097 G-3271 Cap Gasket	
15-4493 O-2041 O-ring	35-5330 O-2226 Standpipe O-ring	27-3059 G-5114 Piston O-ring (2)	
D.E. FILTER-NAUTLIUS-STAINLESS STEEL, FIBERGLASS			
15-2127 O-1062 Tank O-ring	27-2541 O-2292 Valve Body O-ring	27-3060 O-2090 Shaft O-ring	
15-4492 O-2282 2" Bulkhead O-ring	15-4494 G-5076 Square Ring	1 1/2" MULTIPOINT VALVE-TOP MOUNT, SIDE MOUNT	
15-4493 O-2041 Adapter O-ring-Fiberglass	27-5333 O-2091 Valve Body O-ring	27-1103 O-2025 Cover O-ring	
15-4661 O-2141 Air Bleeder Adapt O-r	<i>O-ring/Gasket Kit Available...See pg. 77.</i>		
19-5007 O-2219 Adapter O-rng-Fibergl	SAND FILTER-TRION		
19-2320 O-2215 Bulkhead O-ring	15-4492 O-2282 2" Bulkhead O-ring	27-1162 O-2256 Valve Stem O-ring	
19-2323 O-2106 O-ring	15-4493 O-2041 Closure O-ring	27-1104 G-5106 1 1/2" Diverter Gasket	
19-5008 O-1037 Tank O-ring-Fiberglas	15-4538 G-4324 2" Bulkhead Gasket	27-1106 G-4362 Sight Glass Gasket	
27-4494 O-2002 Valve Adapter O-ring-Fiberglass	15-4661 O-2141 Air Bleeder Adapt O-r	27-2708 O-2059 Valve Adapter O-ring	
27-3513 O-2302 Bleeder O-ring	19-2115 O-2082 Drain Plug O-ring	15-4493 O-2041 Adapter O-ring	
<i>O-ring/Gasket Kit Available...See pg. 77.</i>			
D.E. FILTER-NAUTILUS-POLYMERIC 24, 36, 48			
27-3513 O-2302 Bleeder O-ring	27-4494 O-2002 Valve Adapter O-ring	27-4494 O-2002 O-ring (2)	
15-4492 O-2282 O-ring	35-4053 O-2041 O-ring	2" MULTIPOINT VALVE-TOP MOUNT, SIDE MOUNT	
15-4693 O-2376 Knob O-ring	15-4693 O-2376 Knob O-ring	27-1151 O-2374 Cover O-ring	
27-3514 O-2303 Float O-ring	SAND FILTER-TRITON II		
19-2323 O-2106 O-ring	15-4661 O-2141 Air Bleeder Adapter O-ring	27-1162 O-2256 Valve Stem O-ring	
19-5310 O-1100 Tank O-ring	15-4495 O-2041 Closure O-ring	27-1106 G-4362 Sight Glass Gasket	
19-2320 O-2215 Bulkhead O-ring	15-4492 O-2282 2" Bulkhead O-ring	27-5333 O-2091 Valve Body O-ring	
27-4494 O-2002 O-ring	15-4538 G-4324 2" Bulkhead Gasket	27-4494 O-2002 Adapter O-ring (2)	
15-4661 O-2141 Bleeder Adapter O-rng	15-4492 O-2282 O-ring	15-2501 O-2217 Adapter O-ring	
D.E. FILTER-STAR			
15-5064 O-2189 O-ring-After 11/89	19-2115 O-2082 Drain Plug O-ring	FULL FLOW VALVE	
17-4704 O-1048 Tank O-ring	27-4494 O-2002 Valve Adapter O-ring	19-2039 O-2220 O-ring	
19-1424 O-2071 Bottom Piping O-ring	27-3513 O-2302 Bleeder O-ring	27-5300 O-2332 O-ring	
19-1474 O-2115 O-ring-After 11/89	27-2541 O-2292 Valve Body O-ring	27-4494 O-2002 Adapter O-ring (2)	
19-1479 O-2256 O-ring-After 11/89	27-1106 G-4362 Sight Glass Gasket	SKIMMER	
27-3011 O-2024 O-ring	15-4493 O-2041 O-ring	51-3033 G-3267 Face Plate Gasket-Skim Clean	
15-5564 O-2189 O-ring	35-4571 O-2195 Adapter O-ring	PARAPORT	
<i>O-ring/Gasket Kit Available...See pg. 77.</i>			
D.E. FILTER-TURBO			
15-4492 O-2282 2" Bulkhead O-ring	1 1/2" 6 WAY TOP MOUNT VALVE		
15-4661 O-2141 Air Bleeder Adapt O-r	27-2511 O-2261 Diverter Shaft O-ring	GENERAL PURPOSE MULTIPOINT VALVE	
17-4704 O-1048 Tank O-ring	35-4053 O-2041 Valve Top O-ring	C64057 O-2141 Bleeder Adapter O-rng	
19-2323 O-2106 O-ring	27-3513 O-2302 Bleeder O-ring	C64069 G-4388 Sight Glass Gasket	
27-3062 O-2040 O-ring	27-2541 O-2292 Valve Body O-ring	POLARIS	
27-4494 O-2002 2" Bulkhead O-ring	27-1106 G-4362 Sight Glass Gasket	BOOSTER PUMP-3/4 HP PUMP FOR 180, 280 AND 380 MODELS; PB-4	
SAND FILTER-P.F. 35, 50, 100 ST. STEEL			
15-2038 O-1056 22" Tank O-ring	15-4493 O-2041 O-ring	P-55 MS-1000 Pump Seal	
15-2127 O-1062 18" Tank O-ring	15-4005 O-2114 O-ring	P-95 O-2209 Bracket to Volute O-r	
15-2235 O-1071 16" Tank O-ring (100)	15-4004 O-2283 O-ring	P-40 O-2024 O-ring	
15-4661 O-2141 Air Bleeder Adapt O-r	27-4494 O-2002 O-ring	<i>Repair/Service Kit Available...See pg. 75.</i>	
15-4491 O-2100 1 1/2" Bulkhead O-rng	1 1/4" 4 WAY VALVE-FOR SAND DOLLAR		
15-4492 O-2282 2" Bulkhead O-ring	27-2707 O-2253 O-ring	VAC SWEEP	
15-4538 G-4324 2" Bulkhead O-r (100)	27-2708 O-2059 O-ring	C-140 O-2124 Thrust Jet O-ring	
15-4539 G-4296 1 1/2" Bulkhead O-rng	2" HI-FLOW DIAL-TROL VALVE-26-1049		
15-4693 O-2376 Knob O-ring	27-2406 O-2124 Diverter O-ring	D-24 O-2144 O-ring For D-22, D-23	
15-2038 O-1087 22" Tank O-ring(PF50)	27-4494 O-2002 Adapter O-ring	P-40 O-2024 Shaft O-ring	
<i>O-ring/Gasket Kit Available...See pg. 77.</i>			
2" PVC SLIDE VALVE-26-1165			
27-3060 O-2090 Shaft O-ring	1 1/2" MULTIPOINT VALVE-TOP MOUNT, SIDE MOUNT		
27-3062 O-2040 Cap O-ring	27-1103 O-2025 Cover O-ring	27-1162 O-2256 Valve Stem O-ring	
27-3059 G-5114 Piston Gasket	27-1104 G-5106 1 1/2" Diverter Gasket	27-1106 G-4362 Sight Glass Gasket	
27-3090 O-2068 O-ring	27-1106 G-4362 Sight Glass Gasket	27-5333 O-2091 Valve Body O-ring	
27-2406 O-2124 O-ring	27-4494 O-2002 Adapter O-ring (2)	27-4494 O-2002 Adapter O-ring (2)	
<i>Repair/Service Kit Available...See pg. 77.</i>			
POOLCO			
VORTEX XL PUMP			
3XL SCOR O-2007 Strainer Cover O-ring	3XL SCOR		
3XL SOR O-2341 Threaded Strainer	1 1/2" O-ring		
2XLXLVBHOR O-2025 Pump Housing O-ring	2XLXLVSEAL MS-200		
2XLXLVSEAL MS-200 Pump Seal			

EQUIPMENT CROSS REFERENCE

FITS		
OEM#	SSC#	DESCRIPTION
CARTRIDGE FILTER-CW 650, 900, 1200 & D.E. FILTER-500/DE700		
65CW FHOR	O-2294	Filter Head O-ring
1XL FP	O-2223	Air Relief Plug O-ring
SAND FILTER-PV1000 & ULTRA CLEAR 16T-26T		
16T PG	10315PL	Pressure Gauge
16T VT	O-2094	Valve to Tank O-ring
65CW PLUG	WP-20	Threaded 1 1/2" Plug with O-ring
9CP 1110-1	O-2350	End Cap with O-ring

PRAHER		
4 WAY MULTIPOINT VALVE-MODEL 3334		
T15-E3	O-2211	Cover O-ring
T15-E6	O-2134	Diverter O-ring

PREMIER		
225, 255 PUMPS		
29-113	O-2024	Shaft O-ring
29-674	O-2195	1 1/2" Tailpiece O-ring
31-813	MS-1000	Pump Seal (Original Spa Pump)
31-161	O-2187	Volute O-ring (Later Version)
31-812	MS-200	Pump Seal (Later Ver)
31-486	O-2228	Lid O-ring (Later Ver.)
31-256	O-2041	Volute O-ring (Original Spa Pump)
320, 325, 355 PUMPS		
31-158	O-2262	Volute O-ring
31-812	MS-201	Pump Seal
29-113	O-2024	O-ring
<i>Repair/Service Kit Available...See pg. 75.</i>		

455 BRONZE PUMP		
29-113	O-2024	Shaft O-ring
31-276	G-3256	Volute Gasket
31-486	O-2228	5" Lid O-ring
31-813	MS-1000	Pump Seal
33-248	G-3240	Suction Pot Gasket
33-489	O-2167	6" Lid O-ring
31-159	O-2026	O-ring
33-248	G-3248	Strainer to Volute Gsk

456 B/N PUMP		
29-113	O-2024	O-ring (2)
31-813	MS-1000	Pump Seal
31-159	O-2026	Volute O-ring
25-229	O-2226	O-ring (2)

555 NORYL PUMP		
31-813	MS-1000	Pump Seal
25-229	O-2226	Pot to Volute O-ring
33-229	O-2189	Pot to Volute O-ring
31-486	O-2228	Lid O-ring
35-162	O-2209	Volute O-ring
29-113	O-2024	O-ring (2)
29-674	O-2195	Tailpiece O-ring
<i>Repair/Service Kit Available...See pg. 75.</i>		

FITS		
OEM#	SSC#	DESCRIPTION
556 AB PUMP		
29-113	O-2024	O-ring
31-813	MS-1000	Pump Seal
39-271	G-3220	Gasket
33-248	G-3240	Trap/Volute Gasket
33-489	O-2167	O-ring
556 N PUMP		
29-113	O-2024	O-ring (2)
35-162	O-2209	Volute O-ring
31-813	MS-1000	Pump Seal
29-674	O-2195	Tailpiece O-ring
25-229	O-2226	O-ring (2)
33-489	O-2167	O-ring

575 PUMP		
29-113	O-2024	1/2" O-ring
31-159	O-2026	Volute O-ring
31-813	MS-1000	Pump Seal
35-162	O-2209	Volute to Adapter O-rng

658 BRONZE, 680 PUMPS		
29-113	O-2024	Shaft O-ring
31-812	MS-201	Pump Seal
33-248	G-3240	Pot to Volute Gasket
39-271	G-3220	Bracket to Volute Gsk
39-441	O-2032	8" Lid O-ring
31-813	MS-1000	Pump Seal
32-248	G-3240	Strainer to Volute Gsk

RENEGADE PUMP		
25-229	O-2226	2" Tailpiece O-ring
29-113	O-2024	Shaft O-ring
31-812	MS-201	Pump Seal
33-489	O-2167	6" Trap O-ring
29-674	O-2195	O-ring
31-420	O-2306	Volute O-ring

CARTRIDGE FILTER-HERCULES II		
29-113	O-2024	1/2" O-ring (2)
27-379	G-4283	Gasket

D.E. FILTER-ATLAS		
29-225	O-2006	O-ring
23-671	O-1039	O-ring

PUREX

A, AH SERIES PUMPS		
71416	O-2138	Seal Flange O-ring
71421	O-2247	Lid O-ring
P-29300	MS-201	Pump Seal

AQUATRON, AQUATRON II, QUIETFLO PUMPS		
71422	O-2041	Lid O-ring
71427	O-2209	Bracket to Volute Flange O-ring
71733	MS-501	Pump Seal
<i>Repair/Service Kit Available...See pg. 75.</i>		

FITS		
OEM#	SSC#	DESCRIPTION
C SERIES PUMP (EASTSIDE COMMERCIAL PUMP)		
70943	G-4123	Volute Gasket
71725	MS-360	Pump Seal
71423	O-2249	Seal Flange O-ring
71433	O-1067	Cover O-ring
71423	O-2604	Bracket to Volute Flange Gasket
70943	G-4247	Pot to Volute Flange Gasket
<i>Repair/Service Kit Available...See pg. 75.</i>		

L SERIES PUMP		
70940	G-3255	Strainer Gasket
70941	G-3247	Bracket to Volute Gsk
71416	O-2138	Bracket to Volute O-rng
71421	O-2247	Cover O-ring
71728	MS-201	Pump Seal
<i>Repair/Service Kit Available...See pg. 75.</i>		

WHISPERFLO PUMP		
71417	O-2209	Bracket to Volute O-rng
71419	O-2208	Impeller Lock Screw O-ring
71422	O-2041	Cover O-ring
71444	O-2103	Diffuser O-ring
71445	O-2216	Seal Plate O-ring
71734	MS-1000	Pump Seal
75713	O-2208	O-ring
<i>Repair/Service Kit Available...See pg. 75.</i>		

CARTRIDGE FILTER-CF-40, 60, 80		
71441	O-1063	Tank O-ring-CF 24-80 & 700
<i>O-ring/Gasket Kit Available...See pg. 77.</i>		

CARTRIDGE FILTER-CFM FIBERGLASS		
74021	O-2234	Manifold O-ring
71439	O-1029	Body O-ring

CARTRIDGE FILTER-STAINLESS STEEL-CFW120, 180, 315, 405		
71442	O-1073	Tank O-ring
70952	G-3175	Air Relief Lid O-ring

D.E. FILTER-800 STAINLESS		
70952	G-3175	Lid Air Relief Gasket
71431	O-2231	O-ring
71443	O-1074	Channel O-ring

D.E. FILTER-SM/SMBW 4000 SERIES		
71435	O-2124	Rotor Valve O-ring
71439	O-1029	Tank O-ring
71426	O-2165	Collar & Rotor O-ring
71427	O-2209	Valve 3 Port O-ring

D.E. FILTER-2000 SERIES STAINLESS-SMBW 2024, 2035, 2048, 2060, 2072, 1018, 1027, 1036, 1045, 1054		
71435	O-2124	Rotor Shaft O-ring
71426	O-2165	Collar Rotor O-ring
71428	O-2220	Brass Rotor O-ring
70952	G-3175	Lid Air Relief Gasket
73270	O-1154	Filter Tank O-ring
35-4535	O-2214	Valve Body O-ring
35-5330	O-2226	Collar Rotor O-ring

EQUIPMENT CROSS REFERENCE

FITS OEM#	SSC#	DESCRIPTION
SAND FILTER-TAHITIAN-HR-21, 25, 31		
71426	O-2165	Adapter O-ring
71434	O-2221	Rotor Shaft O-ring
71448	O-2034	Valve Body O-ring
<i>O-ring/Gasket Kit Available...See pg. 77.</i>		
TAHITIAN VALVE		
71448	O-2034	Valve Body O-ring
71434	O-2221	O-ring
71426	O-2165	O-ring
BACKWASH VALVE-2000 SERIES		
71427	O-2209	O-ring
71435	O-2124	Rotor Shaft O-r-Noryl
71428	O-2220	Rotor Shaft O-r-Brass
71426	O-2165	Collar & Rotor O-r-g (2)
ORTEGA VALVE		
72555	O-2024	Shaft O-ring
72553	O-2030	1 1/2" Cover O-ring
72554	O-2044	2" Cover O-ring
ORTEGA 3-PORT BRASS & CPVC VALVES- WITH BRASS OR NORYL DIVERTERS		
72555	O-2024	Shaft O-ring
72553	O-2030	1 1/2" Cover O-ring
72554	O-2044	2" Cover O-ring
ORTEGA II MOTORIZED VALVES-2 & 3 PORT		
71436	O-2090	Shaft O-ring
72555	O-2024	Shaft O-ring (2)
72553	O-2030	1 1/2" Cover O-ring
72554	O-2044	2" Cover O-ring
75114	G-4624	1 1/2" Valve Gasket

RAINBOW		
VACUUM PUMP-CONCORDE		
37121	O-2324	Plate O-ring
37009	O-2326	Motor Housing O-ring
CARTRIDGE FILTER-DYNAMIC SERIES I		
17-2224	O-2135	Valve O-ring
17-2223	O-2095	Lid O-ring
17-2222	G-4337	Cartridge Gasket
<i>O-ring/Gasket Kit Available...See pg. 77.</i>		
CARTRIDGE FILTER-DYNAMIC SERIES II & III		
17-2221	O-2135	O-ring
17-2222	G-4337	Cartridge Gasket
17-2223	O-2095	O-ring
17-2393	O-2082	O-ring
17-2451	O-2087	O-ring
33017	O-2141	Control Valve O-r-g (2)
FEEDERS-IN LINE-310, 312, 320		
17-2009	O-2114	Cap O-ring
17-2009	O-2522	Cap O-ring-Viton
17-2033	G-4327	Saddle Gasket
17-2319	O-2112	Bottom In-Line O-ring
FEEDERS-FREE STANDING-300, 302, 300-19, 300-29, 300-29X		
17-2009	O-2114	Cap O-ring
17-2009	O-2522	Cap O-ring-Viton
17-2263	G-4393	1/2" Saddle Gasket
17-2033	G-4327	3/4" Saddle Gasket

FITS OEM#	SSC#	DESCRIPTION
FEEDER-BROMINE IN-LINE 322		
17-2009	O-2114	Cap O-ring
17-2009	O-2522	Cap O-ring-Viton
17-2319	O-2112	Bottom In-Line O-ring
FEEDERS-HIGH CAPACITY AUTOMATIC- HC-3315, 3330, 3340		
17-2221	O-2135	Vent Valve O-ring
17-2223	O-2095	Lid to Housing O-ring

RICHARDSON/SEABLUE		
SAND FILTER-S/S, FIBERGLASS SIDE MOUNT		
5099-149	O-2278	O-ring
5099-525	O-2152	1 1/2" Valve Adapter O-ring
5099-518	G-5064	Gasket
5099-504	G-4395	Air Bleeder Gasket
5099-125	O-1152	18" Tank O-ring
5099-135	O-1076	22" Tank O-ring
SAND FILTER-FIBERGLASS TOP MOUNT		
5535-101	O-2058	O-ring
5099-518	G-5064	Gasket
CARTRIDGE FILTER-DYNAPURE		
4546-001	O-1153	O-ring

SEASON MASTER		
SKIMMER		
SMS-1094G	G-4001	Face Plate Gasket (2)
SMS-1023G	G-4290	Wall Fitting Gask Set

SONFARREL (MARTEC)		
POOL MASTER PUMP		
320-102	O-2167	Lid O-ring
700-103	O-2195	Union O-ring
201-002	O-2220	Bleed Plug O-ring
320-108	G-4033	Square Flange Gask
320-110	O-1082	Volute Housing O-ring
320-119	MS-201	Pump Seal
SPA MASTER AND H&L ASSEMBLY		
320-102	O-2167	6" Lid O-ring
700-103	O-2195	1 1/2" Union O-ring
201-010	O-2024	Plug O-ring
300-004	O-2025	Face Plate O-ring
300-009	MS-1000	Pump Seal
CARTRIDGE FILTER-IC & IF, TS & TT		
201-002	O-2220	Shaft O-ring
201-044	O-2041	Filter O-ring
201-010	O-2024	O-ring
CARTRIDGE FILTER-SS, ST, SK SUCTION		
201-004	O-2041	Filter O-ring
CARTRIDGE FILTER-LARGE CAPACITY TOP LOAD		
205-104	O-2024	O-ring
205-106	O-2294	Bleed Plug O-ring

FITS OEM#	SSC#	DESCRIPTION
SPECK		
BADUJET MODEL 21-80-WITH BS HAIR & LINT POT		
2920141230	O-2220	Filler Plug O-ring
2923541220	O-2024	Drain Plug & Shaft O-ring
2923441200	O-2221	Casing O-ring
2923141000	G-4448	Gasket
2991500001	O-2381	Bearing O-ring (Prior 1/86)
2920941210	O-2293	Lid O-ring (Prior 1/95)
MODEL 90 PUMP		
2921141210	O-2304	Lid O-ring
2920141240	O-2141	Plug O-ring
2920141210	O-2071	Diffuser O-ring
2921141220	O-2307	Casing O-ring

STA RITE / SWIMQUIP		
ABG PUMP		
35505-1438	O-2266	Seal Plate O-ring
37400-027S	MS-851	Pump Seal
35505-1437	O-2086	Trap Lid O-ring
AJ, PE, PEA PUMPS		
U109-358SS	MS-100	Pump Seal
U9-228	O-1082	Clamp O-ring
U9-226	O-2195	Diffuser O-ring
C20-79	G-3226	Seal Plate Gasket
<i>Repair/Service Kit Available...See pg. 75.</i>		
CC PUMP		
C20-19	G-3240	Flange Gasket
C20-77	G-3261	Pump Gasket
U109-220	MS-381	Pump Seal
U9-171	O-2107	8" Lid O-ring
U9-265	O-2271	Shaft O-ring
C20-101	G-3197	Seal Gasket
C20-100	G-3199	Gasket
CF PUMP		
C20-72	G-3256	Head Gasket
U109-136	MS-1000	Pump Seal
U9-046	O-2167	Lid O-ring
U9-161	O-2218	5" Lid O-ring
C110-17	E-6502	Pump Shaft Extension
<i>Repair/Service Kit Available...See pg. 75.</i>		
CK, CRA4 PUMPS		
N20-26	G-3236	Seal Plate Gasket- Low Heads
N20-35	G-3259	Seal Plate Gasket- High Heads
U109-93	MS-100	Pump Seal
U9-45	O-2099	Lid O-ring
C69-2	G-4253	Slinger Gasket
L21-1	G-5034	Diffuser O-ring
CENTRIFUGAL PUMP-CSPH, CCSPH		
S04757	G-3412	Volute to Bracket Gsk
33455-8044	G-3409	Impeller to Shaft Sleeve Gasket
33455-8043	G-3408	Impeller to Washer Gasket
33450-8042	G-3410	Volute Discharge Gsk
33450-8041	G-3411	Volute Suction Gask.

EQUIPMENT CROSS REFERENCE

FITS

OEM# SSC# DESCRIPTION

CENTRIFUGAL PUMP-ED SERIES

C20-21 G-3151 Gasket

D PUMP

C20-46 G-3164 Gasket
 U109-220 MS-381 Pump Seal
 U9-265 O-2271 Shaft O-ring
 C20-100 G-3199 Gasket

DURA GLAS PR, P2R, PRA, P2RA & MAX-E-GLAS PE, PEA PUMPS

C20-19 G-3240 Tank Body/Trap
 Gasket-Fiber
 C20-19 G-4411 Tank Body/Trap
 Gasket-Rubber
 U9-226 O-2195 Diffuser O-ring
 U9-228 O-1082 Pump Clamp O-ring
 U9-229 O-2060 Lid O-ring
 16920-0012 O-2095 O-ring For 6" Trap
 U109-93 MS-100 Seal-Before 1998
 17304-0100 MS-200 Seal-After 1998
Repair/Service Kit Available...See pg. 75.

DURA-GLAS II P4R, P4RA & MAX-E-GLAS II P4E, P4EA, P4EAA PUMPS

U9-376 O-2142 Seal Insert O-ring
 35505-0422 O-1082 Seal Plate O-ring
 U9-374 O-2002 Diffuser O-ring
 U9-375 O-2247 Trap Cover O-ring
 35505-1426 O-2386 Impeller Screw O-ring
Repair/Service Kit Available...See pg. 75.

DURA JET SPA PUMP-JS SERIES

37400-0027S MS-851 Pump Seal
 U9-229 O-2060 O-ring

DYNA GLAS & DYNA MAX PUMPS-3/4 THRU 2 HP

U9-358SS MS-201 Pump Seal
 U9-374 O-2002 Diffuser O-ring
 U9-375 O-2247 Lid O-ring
 U9-373 O-2305 Seal Plate O-ring
 33455-1047 G-5072 Impeller Screw Gask
Repair/Service Kit Available...See pg. 75.

DYNA JET PUMP

33455-1047 G-5072 Lock Screw Gasket
 U9-374 O-2002 Diffuser O-ring
 U9-373 O-2305 Seal Plate O-ring

FLOTEC A/G PUMP

C20-31B G-4412 Volute Gasket
 U109-68 MS-163 Pump Seal
 U9-295 O-2099 Lid O-ring

FLOTEC PUMP

37407-0019 MS-201 Pump Seal
 17140-0026 G-4641 Body Gasket

FLO TECH PUMP

U9-358SS MS-201 Pump Seal
 C69-2 G-4253 Water Slinger
 U9-374 O-2002 Diffuser O-ring
 U9-399 O-2247 Cover O-ring
 U9-373 O-2305 Seal Plate O-ring
Repair/Service Kit Available...See pg. 75.

FITS

OEM# SSC# DESCRIPTION

HF, HHF, HPA, SEABLUE BPA PUMPS

C20-19 G-3240 Str to Volute Gasket
 C20-72 G-3256 Volute to Motor Gask
 U109-136 MS-1000 Pump Seal
 U9-45 O-2099 4" Lid O-ring
 U9-46 O-2167 6" Lid O-ring
 U9-161 O-2218 5" Lid O-ring
 U9-229 O-2060 Trap Cover O-rg(HPA)
 C20-123 G-4441 Strainer to Volute
 Gasket-Rubber

JWPA PUMP

U9-266 O-2195 O-ring
 U109-358 MS-380 Pump Seal
 U9-357 O-2266 Front Plate O-ring
 U9-229 O-2060 Trap Cover O-ring
 C20-123 G-4441 Gasket

JW & JWA5 PUMPS

U9-226 O-2195 O-ring
 U109-358 MS-380 Pump Seal
 U9-357 O-2266 Front Plate O-ring

LT PUMP

C20-031 G-4412 Head Gasket
 U109-68 MS-163 Pump Seal

PLBC SERIES PUMP-PLBC-149L, PLBC-178L, PLBCL 1/2 HP

U9-389 O-1011 O-ring
 U109-93SS MS-100 Pump Seal
 U9-199 O-2231 Diffuser O-ring
 L20-40 G-4620 Gasket

XL-6 SERIES SELF PRIMING PUMP

37400-0027S MS-851 Pump Seal
 35505-1408 O-2025 Bracket O-ring
 35505-1338 O-2121 O-ring

XL-V11 METERIZER PLASTIC PUMP

37400-0027S MS-851 Pump Seal
 35505-1408 O-2025 Bracket O-ring
 16920-0012 O-2095 O-ring

CARTRIDGE FILTER-STAINLESS-T SERIES/POSIFLO

WC9-3 O-1010 Tank O-ring
 U9-301 O-2047 Top O-ring

CARTRIDGE FILTER-POSI FLO&POSI FLO II

WC9-3 O-1010 Tank O-ring
 31935-0001 O-2046 Lid O-ring-70, 100,
 135 Sq. Ft.
 U9-359 O-2024 Air Release O-ring-
 135 Sq. Ft.

O-ring/Gasket Kit Available...See pg. 77.

CARTRIDGE FILTER-SYSTEM 3-S7M120, S8M150

35505-1423 O-2092 O-ring
 35505-1428 O-2040 O-ring
 35505-1429 O-2231 O-ring
 35505-1424 O-2002 O-ring
 35505-1425 O-2114 O-ring
 U9-362 O-2111 Adapter O-ring

FITS

OEM# SSC# DESCRIPTION

CARTRIDGE FILTER-SYSTEM 3 MODULAR MEDIA-PLM100 & PLM150

27001-0061S O-2086 Cord O-ring
 35505-1424 O-2002 O-ring

CARTRIDGE FILTER-TXC25B, TXC50B, TXC75, TXC100

35505-1157 O-2102 O-ring
 WC9-11 O-1059 Seal Ring
O-ring/Gasket Kit Available...See pg. 77.

D.E. FILTER-DEP, DEP-01B-VERTICLE

35505-1317 O-2100 Cap O-rg (All Models)
 35515-1296 O-2403 Outlet Elbow O-ring
 (All Models)
 24751-5 O-1009 Tank O-ring (DEP51,
 HRP24)
 24752-5 O-1046 Tank O-ring (DEP83,
 HRP30)
 24750-5 O-1106 Tank O-ring (DEP36,
 HRP20)
O-ring/Gasket Kit Available...See pg. 78.

D.E. FILTER-DEPB 36, 51, 83

35505-1317 O-2100 O-ring
 24750-0006 O-1151 Tank O-rng (DEPB 20)
 24751-0006 O-1155 Tank O-rng (DEPB 24)
 24752-0006 O-1156 Tank O-rng (DEPB 30)
 35515-1296 O-2403 O-ring

D.E. FILTER-STAINLESS DES 25-01B, 36-01B, 5-01B, 60-01B

24700-0068 O-1133 Tank O-ring (25-01B)
 24700-0072 O-1015 Tank O-ring (36-01B)
 24700-0073 O-1002 Tank O-ring (60-01B)

D.E. FILTER-SYSTEM 3-S7D75, S8C110

35505-1423 O-2092 O-ring
 U9-362 O-2111 Adapter O-ring
 35505-1425 O-2114 O-ring
 35505-1424 O-2002 O-ring

D.E. FILTER-SYSTEM 3 MODULAR MEDIA & MODULAR D.E.-PLM100, 150-MOD MEDIA, PLD50, 70-MOD D.E.

27001-0061S O-2086 Cord O-ring (3/97 -
 Present)
 27001-0060S O-1157 Cord O-ring (Pre 3/97)
 35505-1424 O-2002 O-ring

SAND FILTER-CRISTOL FLO-T-170BP, T-200BP, T-240BP, T-300BP

U9-369 O-2094 Valve Flange O-ring
 U9-370 O-2259 Lateral O-ring
 U9-371 O-2134 Drain Cap O-ring

SAND FILTER-CRISTOL-FLO HIGH RATE-T-150BP-1, T-170BP-1, T-200BP-1, T-240BP-1, T-300BP

U9-369 O-2094 Valve Flange O-ring
 U9-370 O-2259 Lateral O-ring
 U9-371 O-2134 Drain Cap O-ring
 U9-226 O-2195 Union Coupling O-ring

SAND FILTER-HIGH RATE-HRS16-01, HRS20-01, HRS24-01

24700-068 O-1133 O-ring (HRS16-01)
 24700-0072 O-1015 O-ring (HRS20-10)
 24700-0073 O-1002 O-ring (HRS24-01)

EQUIPMENT CROSS REFERENCE

FITS	FITS	FITS
OEM# SSC# DESCRIPTION	OEM# SSC# DESCRIPTION	OEM# SSC# DESCRIPTION
SAND FILTER-MODELS HRP20, 24, 30 24750-5 O-1106 20" Tank O-ring 24751-5 O-1009 24" Tank O-ring 24752-5 O-1046 30" Tank O-ring 35515-1296 O-2403 Valve Connection O-rg 35505-1317 O-2100 1 1/2" Bulkhead O-rng	PLASTIC SLIDE VALVE 35505-1246 O-2280 O-ring 35505-1318 O-2010 O-ring U9-362 O-2111 O-ring 35505-1116 O-2082 Shaft O-ring SEPARATION TANK-THERMOPLASTIC-60SEP U9-359 O-2024 O-ring 31935-0001 O-2046 O-ring WC9-3 O-1010 O-ring	CARTRIDGE FILTER-1 1/2" & 2" IN-LINE 805-0114 O-2133 Air Relief O-ring 805-0360 O-2095 Filter Top O-ring CARTRIDGE & D.E. FILTER-CLEARWATER-D.E. MODELS FD044, FD067, FD090; CARTRIDGE MODELS FC075, FC100, FC150 805-0383 O-2388 O-ring SAND FILTER-CLEARWATER-FS016 (16"), FS019 (19"), FS022 (22") 711-1920 G-4609 Gasket
SAND FILTER-HRPB 20, 24, 30 35505-1317 O-2100 1 1/2" Bulkhead O-ring 24750-0006 O-1151 Tank O-ring (HRPB20) 24751-0006 O-1155 Tank O-ring (HRPB24) 24752-0006 O-1156 Tank O-ring (HRPB30) 35515-1296 O-2403 O-ring	VICO BIG FOOT PUMP PPULPLUG O-2024 Plug O-ring PPBFV/OR O-2209 Pump O-ring PPUFSEAL MS-201 Pump Seal WOW PUMP PPSFSEAL MS-201 Pump Seal PPWWVO/R O-2005 Volute O-ring	WET INSTITUTE WA PUMP 34-050-303 O-2247 Lid O-ring 34-050-309 G-3207 Trap to Volute Gasket 34-050-312 O-2026 Bracket O-ring D.E. FILTER 32-050-715 O-1061 18" Tank O-ring
SAND FILTER-SYSTEM 3-S7550, S8S70 35505-1423 O-2092 O-ring 35505-1424 O-2002 O-ring 35505-1425 O-2114 O-ring	WATERCO TURBOTUF, TURBOTUF E, HYDROSTORM PUMP 634002 O-2167 H/L Pot Lid O-ring 634017 O-2146 Mounting Bracket O-ring 634011 O-2100 Diffuser Gasket 6340113 O-2117 Diffuser O-ring 6340241 O-2002 Union O-ring SUPATUF PUMP 635028 O-2214 Body O-ring 634016 MS-601 Pump Seal 63151 O-2167 H/L Pot O-ring 6340241 O-2002 50MM Union O-ring	WMC AT SERIES PUMP AT-1600-S O-1226 Strainer Cover Gask SS-1600-R O-2618 Diffuser Gasket SS-1600-Z-2 MS-201 Pump Seal SS-1600-T O-1209 Housing Gasket JS SERIES PUMP JS-1505R O-2195 Union O-ring JS-1701 O-2041 Housing Gasket-Center Discharge JS-3701 O-2025 Housing Gasket-Side Discharge JS-1702 MS-200 Pump Seal JS-1903 O-2095 Strainer Cover O-ring HYDRON SAND FILTER 62100 O-2266 Neck O-ring 621457 O-2264 Axle O-ring 621462 O-2242 Sight Glass O-ring
SAND FILTER-WATERFORD SYSTEM-JSAL15, JSAL17, JSAL20, 24200, 24201, 24203 U9-369 O-2094 Tank Flange O-ring U9-371 O-2134 Drain Cap O-ring U9-370 O-2259 Lateral Tube O-ring	WATERMATIC G-1000 FEEDER 1-020 G-4451 Rain Cover Gasket 1-190 G-4602 Collar Gasket 1-110 G-4389 Hopper Lid Gasket 1-370 G-4456 Cross Pump Bracket Gasket	<div style="border: 2px solid black; border-radius: 15px; padding: 10px; width: fit-content; margin: auto;"> <p>Please Note: This is only a partial list of the parts we offer. Please refer to the OEM Part# Cross Reference section (pg. 14) for many more listings</p> </div>
1 1/2" MULTIPOINT SIDE MOUNT 14964 & TOP MOUNT 14962 VALVE 35505-1228 O-2255 O-ring 35505-1272 O-2189 O-ring 14962-0021 G-5012 Square Ring	WATERWAY A.G. / SPA PUMP-CENTER DISCHARGE 805-0014 O-2082 Drain Plug O-ring 805-0252 O-2025 Faceplate O-ring 811-1001AB MS-1000 Pump Seal A.G. / SPA PUMP-SIDE DISCHARGE-HI-FLO, SUPER-FLO MODELS 805-0014 O-2082 Plug O-ring 805-0256 O-2041 Volute O-ring 811-1001AB MS-1000 Pump Seal	
1 1/2" MULTIPOINT VALVE-WC112 SERIES-FOR CRISTOL-FLO & WATERFORD 35505-1228 O-2255 Diverter O-ring 35505-1275 O-2209 Cover O-ring U9-369 O-2094 Valve Flange O-ring	CARTRIDGE FILTER-TOP LOAD 715-1001 O-2133 Air Relief O-ring 805-0360 O-2095 Filter Top O-ring 805-01205D O-2053 O-ring <i>O-ring/Gasket Kit Available...See pg. 78.</i>	
1 1/2" (14821) & 2" (14826) BRONZE SLIDE VALVE 35505-1116 O-2082 O-ring 35505-1401 O-2042 1 1/2" Unitrol O-ring 35505-1313 O-2134 2" Unitrol O-ring U9-362 O-2111 O-ring	OLD STA RITE SLIDE VALVE U9-147 O-2024 Cap O-ring-Internal U9-152 O-2134 2" Piston Cap Assembly O-ring U9-174 O-2142 1 1/2" Piston Cap Assembly O-ring	
2" MULTIPOINT VALVE-SIDE MOUNT-WC-212-150P U9-243 O-2067 Cover O-ring U9-244 O-2110 O-ring WC9-2 G-4387 Sight Glass Gasket U9-362 O-2111 Union O-ring (2)		

OEM PART# CROSS REFERENCE

FITS			FITS		
OEM#	SSC#	DESCRIPTION	OEM#	SSC#	DESCRIPTION
A & A MFG.			--	O-2142	Commander 1 1/2" Volute Piston O-ring
820-115	O-2217	Water Valve O-ring	--	O-2222	Air Relief Valve O-ring
A.O. SMITH			--	G-4207	Rubber Washer
23789	G-5022	Spa Element Gasket	--	G-4237	Olympian Filter Gasket
98198	O-2134	Heater By-Pass O-ring	--	F-8215	Titan Stainless Steel DE Filter O-ring Kit
99659	G-4335	Outlet Manifold Gasket	--	F-8316	Commander Cartridge Filter O-ring Kit
99659-1	G-4209	Inlet Manifold Gasket	--	F-8317	Quantum Cartridge Filter O-ring Kit
99660	O-2134	Heater By-Pass O-ring	--	R-6126	Multiport Valve-Before 1976-Repair Kit
ACURA SPA SYSTEMS			--	R-6127	1 1/2" & 2" Bronze & ABS Slide Valve Repair Kit
0163	G-4040	Turbo Blower Cover Gasket	--	R-6128	Multiport Valve-After 1976-Repair Kit
0167	G-4137	Turbo Blower Motor Mount Gasket	--	R-6129	Americana & Bronze Pump Repair Kit
0390	G-3030	Power Quip Heater Gasket	--	R-6130	Eagle Pump Repair Kit
0430	O-2125	Power Quip Heater O-ring	--	R-6143	Ultra Flow & Bronze w/ Bronze Imp. Repair Kit
1058	O-2024	Magna Drain Plug O-ring	--	R-6149	Maxim, Americana II, Power Glas Pump Repair Kit
1059	O-2041	Aquaheat Large Pump O-ring	--	O-2222	Air Relief Valve O-ring
1060	O-2252	Maverick Pump Face Plate O-ring	--	O-2264	Americana Spacemaker O-ring
1061	O-2209	Magna Faceplate O-ring	191016	O-1205	O-ring
1062	O-2226	Magnaflow 2" Union O-ring	192320	O-2159	Clean & Clear Plus Upper Bulkhead O-ring
1081	O-2301	Aquaheat Diffuser O-ring	271151	O-2374	2" P Valve Lid O-ring
1090	MS-1000	Pump Seal	371017	O-2012	Lid O-ring
1660	O-2189	Pump Union O-ring	374058	G-4329	Heater Gasket
ADVANCE			390004	O-2080	Power Pump Lid O-ring
6C-200	MS-200	Pump Seal	390008	G-4120	Power Pump Gasket
6C-201	MS-201	Pump Seal	390022	O-1060	Power Pump Body O-ring
OV-11-006	O-2503	Chlorinator Viton O-ring	390040	O-2195	Diffuser O-ring For Power Pump
OV-11-008	O-2507	Chlorinator Viton O-ring	390060	O-1082	Ultra Flow Pump Volute O-ring
OV-11-009	O-2520	Chlorinator Viton O-ring	390066	O-2111	Ultra Flow Pump Volute O-ring
OV-11-010	O-2521	Chlorinator Viton O-ring	390100	O-2082	Impeller O-ring
OV-11-011	O-2506	Chlorinator Viton O-ring	390102	O-1141	RPM Tank Cover O-ring
OV-11-012	O-2502	Chlorinator Viton O-ring	391015	O-2079	Body O-ring
OV-11-028	O-2505	Chlorinator Viton O-ring	391016	O-2066	Americana II Body O-ring
OV-11-110	O-2508	Chlorinator Viton O-ring	391017	O-2012	Americana II Lid O-ring
OV-11-112	O-2519	Chlorinator Viton O-ring	391019	O-2218	Maxim, Americana II Lid O-ring
OV-11-113	O-2124	Chlorinator O-ring	391028	O-2165	Swivel Union O-ring
OV-11-203	O-2516	Chlorinator Viton O-ring	391029	O-2040	Titan O-ring, Sandpiper O-ring (Current Version)
OV-11-210	O-2515	Chlorinator Viton O-ring	392003	O-2095	Plate to Volute O-ring
OV-11-212	O-2256	Chlorinator O-ring	392014	O-2249	Lid O-ring
OV-11-325	O-2068	Chlorinator O-ring	392014	O-2604	Blue Teflon Coated Lid O-ring
OV-11-332	O-2002	Chlorinator O-ring	392041	O-2060	Eagle Pump Lid O-ring, Filter O-ring
AIRQUATIC			392048	G-4284	Eagle Gasket
5099-149	O-2217	FG Filter Lid O-ring	393003	O-2054	Pump Lid O-ring
ALADDIN			393006	O-2054	Locking Ring Lid O-ring
O-408	O-2122	Vac Master Lid O-ring	395001	G-4285	Noryl Pump Slinger Gasket
ALDEN LEEDS			395001	G-4601	Water Slinger
O-6030	O-2139	Divert-O-Trol Chlorinator O-ring	395004	O-2404	Seal Plate Quad Ring (Prior to 1975)
AMERICAN GRANBY			395005	MS-201	Pump Seal
50-1100BSS	O-2115	1 1/2" Heat Sink O-ring	395012	G-4409	Pot to Volute Pump Gasket
55-1150B55	O-2165	2" Heat Sink O-ring	395013	G-5045	Seal Plate Ring (After 7/75)
AMERICAN PRODUCTS (DIV. OF PENTAIR)			397012	MS-1000	Pump Seal
--	O-1014	Separation Tank O-ring MS6-72	397013	E-6501	Pump/Motor Shaft Extension
--	O-1060	Bottom Seal For Carbide 52/104 Sq. Ft.	397018	O-2026	Pump O-ring
--	O-2008	1 1/2" Collection O-ring	397020	MS-1000	Pump Seal
--	O-2020	Americana Spacemaker Collector O-ring	397028	O-2026	6 3/4" Bronze Pump O-ring
--	O-2024	Separation Tank Air Relief Valve O-ring	421612	O-2262	Power Glass Volute O-ring
--	O-2082	Crank O-ring	422160	G-4221	Power Glass Gasket
--	O-2106	Titan Manifold O-ring	422240	G-4628	Diverter Jet Gasket-2 or 3 Port
--	O-2124	Multiport Valve Rotor Shaft O-ring	423160	O-2129	Super Flo II Cartridge Filter Knob O-ring
--	O-2135	Commander Air Relief O-ring	451170	G-4002	Twin Port Skimmer Sealing Gasket
			453330	G-3141	Pep Main Drain Gasket
			461130	G-4290	2" ID Thick Gasket
			461352	G-4350	Lux Spa Jet Gasket
			467130	O-2090	Diverta Port Valve Bobbin O-ring
			467150	O-2134	Diverta Port Valve Puck O-ring
			467170	O-2165	Diverta Port Valve Cap O-ring
			467220	G-4163	Aqua Fan Gasket
			468155	O-2208	Aqua Lumin Light O-ring

OEM PART# CROSS REFERENCE

FITS OEM#	SSC#	DESCRIPTION	FITS OEM#	SSC#	DESCRIPTION
468240	O-2195	Power Glass Slip Body O-ring	550017	O-1042	24" Tank O-ring
469115	O-2227	Air Control O-ring	550060	G-4440	Sahara Filter Manhole Gasket
469150	O-2160	Standard Air Control O-ring	550067	O-2239	Sahara Drain Filter O-ring
469250	O-2053	Mini Air Control O-ring	570031	O-1060	10" Sep. Tank O-ring
470626	G-4375	Luxury Collection Gasket	570032	O-1014	12" Carbide Filter Tank O-ring
470628	O-2177	Luxury Spa Jet O-ring	570065	O-2090	Commander Gauge Plug O-ring, Maxim Pump O-ring
470642	O-2082	Titan Lid Fitting O-ring	570067	O-2129	Commander Knob Seal O-ring
470690	G-4607	Micro Jet Gasket	570068	O-2239	Eclipse O-ring
472240	G-4608	Diverter Jet Gasket-2 or 3 Port	570073	O-1059	Commander Tank O-ring
472253	G-4378	Diverter Jet Valve Gasket	570078	O-2223	Commander Center Rod O-ring
472264	O-2105	Diverter Jet Valve O-ring	570082	O-2226	Admiral Twin Port Skimmer S20 Equalizer
477210	O-2082	Cyclojet Small O-ring	570087	G-3239	Olympian Filter Fiber Washer
477211	O-2118	Cyclojet Large O-ring	570113	O-2030	Commander II In-Line Cartridge Filter Drain O-ring
501133	G-4371	Bulkhead Gasket	590006	O-2106	Manifold O-ring
501407	G-3277	1 1/2" Multiport Valve T/M Series Gasket	590210	O-1142	CM Tank Cover O-ring
501414	O-2256	1 1/2" Multiport Valve T/M Series O-ring	711001	G-4374	Mini Jet Wall Fitting Gasket
501415	O-2017	1 1/2" Multiport Valve T/M Series Lid O-ring	791016	O-1205	Gasket/O-ring Before 1986
501517	O-2211	Lid O-ring	791016N	O-1212	Light Lens Gasket/O-ring-After 1986
501519	O-2256	Rotor O-ring	791048	G-4297	Rubber Washer
501521	O-2189	1 1/2" Multiport II Valve O-ring	791085	O-1211	Spa Light Lens Gasket/O-ring
501523	O-2378	Meteor Hose Assembly O-ring, Sight Glass O-ring	791143	G-4241	Fun Light Gasket
510004	G-4130	Multiport Cover Gasket	791169	O-2001	Aqua Luminator O-ring
510010	O-2410	New Style Quad Ring	792003	G-3157	Niche Gasket (For Kit Order 2)
510012	O-2133	Multiport Valve Shaft O-ring	792004	G-3158	Standard Hole Niche Gasket (For Kit Order 3)-Fiber
510013	G-5146	Multiport Valve Teflon Backup Ring	792004	G-4165	Standard Hole Niche Gasket (for kit Order 3)-Rubber
510018	G-4300	Multiport Valve Rubber Gasket (For Kit Order 2)	792005	O-2253	O-ring
510022	O-2025	1 1/2" O-ring	792046	G-3146	Spa Light Sealing Gasket (For Kit Order 3)
510023	O-2374	O-ring	792071	O-2120	Hi-Lite O-ring
510026	O-2256	Valve O-ring	793006	G-4438	Junction Box Sealing Gasket
510031	O-2024	Stem & Shaft Cap O-ring	850016	G-3034	Liner Gasket-Fiber (For Kit Order 2)
510032	O-2126	Valve Stem O-ring	850016	G-4008	Liner Gasket-Rubber (For Kit Order 2)
510034	O-2115	Bronze Valve Cap O-ring	850033	G-3011	Rear Gasket For Front Access Skimmer
510035	O-2106	Sand Filter Union O-ring	850034	G-3009	Front Gasket For Front Access Skimmer
510049	G-3148	2" B/V Cap Gasket	850057	O-2231	Manifold O-ring
510050	O-2068	2" B/W Valve Piston O-ring	850077	G-3008	W/T Skimmer Sealing Gasket
510054	G-4319	6 Position Valve Sight Glass Gasket	850151	O-2224	S-20 Skimmer Bottom O-ring
510056	G-5055	Small Separation Tank Ring	860069	O-2150	RPM Bulkhead O-ring
510058	O-2189	Standpipe O-ring	862005	O-2231	Manifold O-ring
510059	O-2208	Air Relief Valve Sep. Tank O-ring	863005	G-4458	Drain Cap Gasket
510061	G-4310	Sight Glass Gasket	863005	G-4611	Predator Drain Cap Gasket
510065	G-4267	Air Relief Valve Sep. Tank Gasket	871020	G-3149	Drain Pump Gasket
510076	G-5024	Separation Tank Lid Ring	872002	G-4290	Thin Line Spa Skimmer Gasket
510084	G-5104	6 Spoke Spider Gasket (Prior to 1976)	872012	G-4290	2" ID Thick Gasket
510084	G-5105	5 Spoke Spider Gasket (After 1976)	872063	G-4160	Aqua Lumin Sealing Gasket
510087	G-4300	Rubber Sight Glass Washer	873004	O-2375	Predator Body O-ring
510104	O-2142	Old Style Piston O-ring	910043	G-4330	Rubber Washer
510116	O-2054	Eclipse Valve O-ring	982085	G-4333	Washer
510119	O-2224	Standpipe O-ring	982207	O-2256	2" P Valve Shaft O-ring
510133	G-4371	Bulkhead Gasket	982214	G-4625	2" P Valve Sight Glass Gasket
510135	O-2106	ABS Valve Body O-ring			
510136	G-4278	Bulkhead Gasket			
510137	G-4237	Bulkhd Gasket-Titan, Sandpiper 18&24, Carbide, Quantum			
510162	O-2175	Directional Valve 2 & 3 Port O-ring	AMPRO		
510167	O-2297	Multiport Valve 2" Lid O-ring	--	O-2042	Large O-ring for Spool 900-8S, 900-7S
510173	G-4394	Valve Gasket	--	O-2248	900-9S Small Spool O-ring
510177	O-2256	2" Valve Stem O-ring	--	G-3144	Selector Valve Gasket-4 3/8" OD
510183	O-2067	2" Multiport Valve Threaded O-ring	1403	O-1052	14" Tank O-ring
510215	G-4647	Eclipse Bulkhead Gasket	200-36	O-2067	Lexan Pump Body O-ring
520001	O-2120	Eclipse Bulkhead O-ring	300-6	O-2146	Noryl Pump Body O-ring
520005	O-2054	Eclipse O-ring	3015-82	O-1137	Cent. 2000 Cover O-ring
530004	G-4298	Shaft Sleeve Gasket	3015-83	O-1017	Tank O-ring
530018	O-2402	Female Bell Quad Ring	504-D	MS-163	Pump Seal
530028	O-1039	18" Tank O-ring	511	G-4446	AP900 P/PL Valve WA Gasket
53003201	103015PL	Gauge	512	G-4348	AP900 P/PI Valve Gasket
530088	O-1143	Quantum Tank O-ring (After 11-94)	513	G-4445	AP900 P/PL Valve LW Gasket
550009	G-4311	Sandpiper Hub Gasket	600-57	O-2121	H&L Pot Lid O-ring
550015	O-1114	Sandpiper Tank O-ring (Before 11-94)	606-78	MS-200	Pump Seal

OEM PART# CROSS REFERENCE

FITS OEM#	SSC#	DESCRIPTION
6-146	G-3250	Gasket
641-36	G-4345	Dura Flo Pump Gasket
646	G-3203	Pump Gasket
900	O-2092	Small Spool O-ring for 900-7S, 8S
900-4	G-4215	Upper Cap Washer
900-9S	O-2001	Large Spool O-ring
AP-304D	MS-1000	Pump Seal

ANTHONY

--	O-2008	Piston O-ring
--	O-2093	1 1/2" Old Style Piston Ring
--	O-2100	Rear Seal O-ring
--	O-2106	Bulkhead Connector
--	O-2121	Hydro H&L Lid O-ring
--	O-2203	New Style Piston O-ring
--	O-2240	4" Pump Lid O-ring
--	O-2282	Old Style Light Base O-ring
--	G-3139	Pump Gasket
--	G-4006	Inlet/Outlet Gasket
--	G-4217	Oval Lid Gasket
--	G-4310	Sight Glass Gasket
--	R-6112	1 1/2"&2" Univ. Bronze & ABS Slide Valve Repair Kit
--	R-6154	1 1/2" Brass Slide Valve Repair Kit
04278	O-1014	Separation Tank O-ring
04380	MS-1000	Pump Seal
04382	G-3253	AC, AS Volute Gasket
04387	O-2218	AC2, AS2 5" Strainer Cover O-ring
04412	O-2214	AR Seal Plate O-ring
04465	G-3226	AJ 105 Sweep Pump Gasket
04466	G-3210	Sweep Pump Gasket 105, VB44
04547	MS-100	Pump Seal
06483	O-1014	Separation Tank 40/60 O-ring
11027	O-2087	Conv. Kit O-ring
12382	O-1025	Ditron Tank O-ring
12388	G-4327	SS Ditron Upright Filter Air Release Valve Gasket
14118	O-1216	Double Bead Light Lens Gasket
15029	G-4431	Old Style Rear Header Gasket
15147	G-4005	Dual Housing Heater Gasket
15448	G-4224	Rubber Tube Seal Gasket
15981	G-4025	Inlet/Outlet Heater Gasket
17433	O-1039	18" Tank O-ring
17434	O-1037	A-40 O-ring
17437	O-2024	Valve Shaft O-ring
17438	O-2006	Spinfilter End Bell O-ring
17606	O-2142	1 1/2" Piston & Valve Cap O-ring
17681	O-2231	3/16" Piston & 2" Cap O-ring
17770	R-6111	2" Plastic Slide Valve Repair Kit
17786	O-2188	Plastic Valve Plunger Rod O-ring
17790	O-2106	2" Plastic Valve Union O-ring
17791	O-2004	Brass Push Pull Valve 1.5 O-ring
17792	O-2188	2" Brass Push-Pull Valve O-ring
17810	R-6111	2" Plastic Slide Valve Repair Kit
27111	G-4326	Large Tube Seal Gasket
6527	O-1158	Separation Tank O-ring
HL4	O-2099	4" H&L Trap O-ring
HL6	O-2247	6" Pump Lid O-ring
LL	O-2018	Lens O-ring
U109-93SS	MS-100	Centrifugal Pump Seal
U9-161	O-2218	Centrifugal Pump Trap Cover O-ring
U9-169	O-2214	Seal Plate O-ring
VB27	G-3169	Volute Pump Gasket

AQUA DYNE (SEE LAARS)

AQUA GENIE (SEE CASCADE)

FITS OEM#	SSC#	DESCRIPTION
AQUA FLO		
--	O-2195	Male Adapter O-ring
--	R-6140	Dominator & C-Before 1995-Pump Repair Kit
--	R-6141	Master & Tubmaster Pump Repair Kit
--	R-6142	Standard A Series 5" Pump Repair Kit
--	R-6145	Dominator & C-After 1995-Pump Repair Kit
91049000	MS-2131	Pump Seal
91500000	G-3151	AC Series Volute Gasket
91500050	G-3256	A Series 1/3 to 2 HP Volute Gasket, B Series Gasket
91500100	G-3220	A Series 3 HP Volute Gasket
91500150	G-3275	A Series 5" Trap Gasket
91500200	G-3240	A Series 6" & 8" Trap Gasket
91500250	G-4407	A Series Drain Gasket
92200000	O-2228	A Series 5" Trap Cover O-ring
92200010	O-2247	A & AC Series 6" Trap Cover O-ring
92200020	O-2032	8" Trap Cover O-ring-AC
92200050	O-2067	C Series Volute O-ring
92200060	O-2141	O-ring
92200070	O-2082	O-ring
92200090	O-2262	FMH Series Volute O-ring
92200100	O-2226	FM, B Series Suction O-ring
92200110	O-2189	FM Series Suction O-ring
92200120	O-2253	Pipe Plug O-ring
92200140	O-2195	O-ring
92200150	O-2252	Volute O-ring
92200160	O-2221	O-ring
92200180	O-1082	O-ring
92200190	O-2128	Dominator Trap Lid O-ring
92200200	O-2025	Flo Master, Tubmaster Volute O-ring
92200210	O-2270	O-ring
92200220	O-2211	Trap Lid O-ring
92200270	O-2252	FMCP Volute O-ring
92200290	O-2149	FMXP Pump Volute O-ring
92500050	MS-1000	Pump Seal
92500150	MS-200	Pump Seal
92509020	MS-200	Pump Seal
92509040	MS-1000	Pump Seal
ACF-11/915	G-3151	Commercial Volute Gasket
AF-10	O-2228	5" Lid O-ring
AF-10-01	O-2247	O-ring
AF-11	G-3256	Volute Gasket
AF-11-01	G-3220	3 HP Volute Gasket
AF-12	G-3275	Trap Gasket
AF-12-1	G-3240	3 HP Trap Gasket
AF-14	MS-1000	Pump Seal
CF-11	O-2067	C Series Volute O-ring, Dominator O-ring
FCF-11	O-2041	O-ring
FF-11	O-2262	O-ring
FF-12	O-2226	O-ring
FF-12-02	G-4407	100% Drain Gasket
FF-12-1	O-2189	O-ring
FF-14	MS-200	Pump Seal
FF-14-02	O-2104	Seal Cup O-ring
FF-17-03	O-2195	O-ring

AQUALEADER (SEE ALSO OLYMPIC)

--	G-4032	Skimmer Face Plate Gasket
--	G-3006K	Skimmer Gasket Kit-2 Sets Totaling 4 Gaskets

AQUA SPORTS

SMS-1094G	G-4001	Face Plate Gasket (for Kit Order 2)
-----------	--------	-------------------------------------

AQUARIUS

--	G-3251	Volute Gasket
----	--------	---------------

OEM PART# CROSS REFERENCE

FITS	OEM#	SSC#	DESCRIPTION
AQUATHERM			
	16-070-200B	MS-1000	Pump Seal
	17-051-003	O-2195	O-ring
AQUAVAC			
	78005	G-4062	Tiger Shark Bottom Lid Gasket
ARNESON (DIVISION OF HAYWARD)			
A-08	MS-200		Pump Seal
A-40	G-5119		A1, A60 Booster Pump Endbell Gasket
AXL12	G-4162		Main Drain Gasket
D-10	G-5043		Hose Washer
E-43	O-2220		Turbo Sweep Seal Plate O-ring
F-07	O-2082		Pool Sweep O-ring
F-24	O-2135		Backup Extension O-ring
G-12	O-2208		Gear Housing O-ring
G-29	G-3238		Gear Housing Gasket
G-29B	G-3237		Gear Housing Gasket
G-32	O-2263		Lower Bearing O-ring
J-04	O-2144		Valve Body O-ring
K-965	O-2243		Body O-ring
K-966	O-2254		Element O-ring
W-430	O-2011		Leaf Cannister O-ring
W-542	O-2300		Pool Vac O-ring
ASTRAL			
00091R0204	O-2254		O-ring
00270R0001	G-4158		Gasket
00273R0001	G-4055		Gasket
00352R0010	G-4605		Compression Ring Gasket
00361R0001	G-4604		Light Gasket
00470R0319	G-4633		Chemical Feeder Drain Gasket
00541R0402	G-4319		Persius Sand Filter Drain Gasket
00541R0404	G-4462		Persius Sand Filter Drain Cap Gasket
00545R0214	G-4295		Gasket
00546R0202	G-4157		Interior Bulkhead Gasket
00600R0001	G-4630		Top Mount M/V Sight Glass Gasket
00612R0001	G-4320		Filter Gasket
00690R0402	G-4156		Sand Filter Drain Gasket
02063	G-4153		Gasket
02064	G-4143		Sand Filter Gasket
02065	G-4154		4" Gasket
02068	G-4155		6" Gasket
103R0003	G-4257		Drain Gasket
11130R0006	G-4631		Offline Chemical Feeder Gasket
1461R0001	G-4049		Skimmer Gasket
15628R9601	MS-1000		Astra Max Seal
271R0002	G-4147		Main Drain Gasket
365R0002	G-4145		Light Gasket
544R0106	G-4392		Gasket
545R0305	G-4144		Bulkhead Gasket
597R0102	G-5106		5 Spoke Spider Gasket
600R0205	G-4383		Valve Plug Gasket
687R0303	G-4146		Sand Filter Gasket
690R0406	O-2224		Sand Filter O-ring
710R0402	O-2224		O-ring
711R1329035	O-2025		Chemical Feeder O-ring
713R0580030	G-4603		Gasket
713R1206053	O-2526		Chlorinator O-ring-Viton
713R1329045	O-2527		Chlorinator O-ring-After 06/03-Viton
721R0089019	O-2135		Bolt O-ring
721R0195030	O-2220		Light O-ring
721R180060	O-2032		Persius Sand Filter O-ring
721R1820060	O-2094		Valve Body O-ring
722R0198035	O-2239		O-ring
722R0198036	O-2239		Multiport Valve Rotor Axle O-ring
722R1100110	O-1145		Light O-ring
722R1362035	O-2128		Multiport Valve Lid O-ring

FITS	OEM#	SSC#	DESCRIPTION
	722R1362035	O-2128	Top Mount M/V Lid O-ring
	723R0049003	O-2152	Persius Sand Filter O-ring
	723R0700050	O-2120	Sand Filter O-ring
	7730599035	O-2226	Astra Max O-ring
	7731329035	O-2025	Astra Max O-ring
	7731520035	O-2011	Astra Max O-ring
	773R0950050	O-2114	Sand Filter O-ring
	773R1450050	O-2266	Sand Filter O-ring
	788R4140120	G-4150	Gasket
BAKER HYDRO			
--		O-2106	Valve Coupler O-ring
--		O-2223	Newport Valve Shaft O-ring
--		F-8324	Mite Cartridge Filter O-ring Kit
00B7000		O-1210	Control Plate Gasket/O-ring
00B7001		O-2106	Bulkhead Fitting O-ring
00B7013		G-5006	Filter Lid Ring (1969-71)
00B7014		O-2188	Valve Piston O-ring (For Kit Order 3)
00B7015		K-6006	Piston O-ring Kit
00B7026		O-2089	Newport Sand Filter Valve Tank O-ring
00B7027		O-2040	Old Style Bulkhead Adapter O-ring
00B7027		G-5058	New Style Bulkhead Adapter Ring-Square Cut
00B7028		G-5006	Baker II Clamp Ring
00B7031		G-5011	Top Mount Sand Filter Gasket
00B7037		O-1021	Tri-Filter Lid O-ring
15B3315		O-2094	Tank O-ring-16, 20, 24
17B1085		G-4216	Cartridge Filter Gasket
17B1087		O-2095	25 Sq. Ft. Lid O-ring
254760		O-2155	Old Style Spa Pak Pump O-ring
284860		G-4231	Old Spa Pak Pump Slinger Gasket
301560		O-2020	Old Spa Pak Pump Gasket
30C3005		O-2025	1 1/2" Multiport Valve Cover O-ring
30C3009		O-2256	1 1/2" Multiport Valve Shaft O-ring
30C3011		G-5106	1 1/2" Spider Gasket-5 Spoke
30C3015		G-4637	Sight Glass Gasket
30C3018		O-2195	TM 1 1/2" Center Tube O-ring
30C3019		O-2195	1 1/2" Valve Plug O-ring
30C3105		O-2374	2" Multiport Valve Cover O-ring
30C3109		O-2256	2" Multiport Valve Shaft O-ring
30C3115		G-4637	Sight Glass Gasket
30C3119		O-2165	2" Valve Plug O-ring
31B0015		G-4268	Baker Valve Top Plate Gasket
31B0024		K-6006	Piston O-ring Kit
31B0035		O-2082	Index Plate O-ring
31B1107		O-2618	Spa Pak Pump Diffuser Gasket
31B9006		G-4271	Sand Filter Bulkhead Fitting Gasket
34B3147-2-V		MS-1000	Pump Seal
35131138		MS-2131	Pump Seal
35B1108		O-1209	Spa Pak Pump Housing Gasket/O-ring
35B1109		MS-201	Pump Seal
35B1116		G-4227	Spa Pak Pump Slinger Gasket
35B1117		G-5039	Spa Pak Pump Lid Gasket
35B1136		G-3125	Spa Pak Pump Housing Gasket
35B1138		MS-2131	Pump Seal
35B1150		G-4435	Spa Pak Pump Gasket
35B1178		MS-200	Pump Seal
374780		G-5014	Old Spa Pak Pump Gasket
374790		G-5010	Old Spa Pak Pump Gasket
374820		G-5052	Old Spa Pak Pump Gasket
394040		G-5016	Old Spa Pak Pump Gasket
51B1047		G-3010	Skimmer Face Ring Gasket (For Kit Order 2)
51B1047		G-3039	Hydro-Pak Face Ring Gasket
MI-29-3		MS-100	Pump Seal
BARACUDA			
67600		O-2093	Zippy/Zippy Pure Wall Adapter O-ring
ADG-5		G-4401	Universal Pool Cleaner Floor Gasket

OEM PART# CROSS REFERENCE

FITS OEM#	SSC#	DESCRIPTION
BERKELY		
--	O-2109	5" H&L Pot Lid O-ring
BILNOR		
1743	G-3283	Skimmer Gasket
1750	G-4132	Return Fitting Gasket
1761	G-4133	Return Fitting Gasket
BIO LAB		
25475HYD	O-2228	Brominator Lid O-ring
254840MN	G-4617	Brominator Gasket
5470	G-4327	Tygon Washer
B-94	O-2228	Brominator Lid O-ring
PC25350	O-2524	MA Chlorinator Cover Viton O-ring
BLUE HAVEN		
--	O-2093	1 1/2" Old Style Piston Ring
BLUE WHITE		
9003-003	O-2208	Chlorinator O-ring
9003-009	O-2135	Chlorinator O-ring
9003-011	O-2248	Chlorinator O-ring
9003-016	O-2257	Chlorinator O-ring
9003-020	O-2205	Chlorinator O-ring
9003-024	O-2281	Chlorinator O-ring
9003-030	O-2141	Chlorinator O-ring
9003-051	O-2227	Chlorinator O-ring
9003-058	O-2051	Chlorinator O-ring
9003-067	O-2220	Chlorinator O-ring
C-350	O-2222	Check Ball O-ring
C-502	O-2248	Tube Adapter O-ring
BRETT AQUALINE		
100022K	O-2262	EM203 Pump O-ring
37-0101BK	G-4606	Light System Gasket
60-0001	O-2086	EM103 Heater & Pump O-ring
60-0002	G-4381	Current Collector O-ring
61-0001	G-4344	EM 103 Heater and Pump Gasket
63-0001	G-4397	Current Collection Gasket
BUSTER CRABBE		
20-1040	G-4229	Pump Gasket
C & R		
20-1040	G-4229	Pump Gasket
20-2056	O-2226	2" Union O-ring
CAL FOUNTAIN PUMPS		
--	G-4453	Volute Gasket-No. 3
--	O-2177	Volute O-ring-A180, 210A
10240	O-2324	Volute O-ring-A280, 320, 430-A
11190	O-2215	Volute O-ring-5580, 900, 1220-S
CAPITOL		
G-106	G-4214	Chlorinator Gasket
CARETAKER SYSTEMS (CSI) (HYDROSTORM PUMP)		
1131	O-2089	Large O-ring
1132	O-2189	Small O-ring
1133	O-2282	Union O-ring
413-0501	O-2165	Mounting Bracket O-ring
413-0575	O-2146	3/4-2 HP Diffuser O-ring
413-0620	O-2224	Lid O-ring
413-0640	O-2002	Union Assembly O-ring

FITS OEM#	SSC#	DESCRIPTION
634002	O-2167	Hydrostorm Pot Lid O-ring
634011	O-2100	Hydrostorm Pump Diffuser O-ring
6340113	O-2117	Hydrostorm Diffuser O-ring
634017	O-2146	Hydrostorm Mounting Bracket O-ring
6340241	O-2002	Hydrostorm Union O-ring
CASCADE (AQUA GENIE)		
500010	G-3027	Aqua Genie Faceplate Gasket-Fiber
500010	G-4034	Aqua Genie Faceplate Gasket-Rubber
500011	G-4035	Aqua Genie Oriface Gasket
CHEMTECH		
27903	G-3184	Series 100/200 Gasket
27911	G-3028	Series 200 Motor Housing Gasket
42031	G-3186	Series 200 Gasket-Fiber
CLAYTON		
P-4450	G-4051	Face Plate Gasket
COLECO		
--	G-4405	Hydro Gasket
30483	G-4026	Hydro Skim Gasket
30484	G-4114	Return Fitting Gasket
31954	O-2264	Top O-ring
31992	O-2142	Top O-ring
33185	O-2040	Cover O-ring
33221	O-2266	Pump O-ring
33235	O-2114	Cover O-ring
33236	O-2203	Strainer Inlet O-ring
33510	O-1023	Fiberglass Tank O-ring
34023	G-4309	Gasket
34027	G-4295	Gauge Gasket
37280	G-4405	Hydro Skimmer Float Gasket
38213	G-4043	Skimmer Gasket
COLUMBIA		
--	R-6153	Blue Seal Repair Kit
COMFORTZONE (DIVISION OF HAYWARD)		
CZXGKT7408	G-4452	Bucket Gasket (For Kit Order 2)
CZXGKT9216	G-4626	C-SPA XI Inlet/Outlet Gasket
GKT-1930	G-4021	CZ/HMZ Gasket
GKT-7401	G-4007	Large Bucket Gasket (For Kit also Order G-4018)
GKT-7402	G-4018	Small Bucket Gasket (For Kit Also Order G-4007)
COMPOOL (DIVISION OF PENTAIR)		
OR-4	O-2220	Shaft O-ring
OR-6	O-2175	Cover O-ring
CONGER BROTHERS		
--	O-2116	Mini Air Control O-ring
--	O-2142	Large Air Control O-ring
--	O-2270	O-ring-2 3/4" OD x 1/8" TH
--	O-2256	O-ring- 1 1/8" OD x 1/8" TH
DANNER		
--	O-2009	Model 350 Cover Pump O-ring
DELUXE HEATER		
20-3212	K-6011	O-ring/Gasket Kit

OEM PART# CROSS REFERENCE

FITS OEM#	SSC#	DESCRIPTION
DIALCEAR		
035-3400	G-3282	HPE Diaclear Gasket
35100	MS-163	Pump Seal
35104	MS-142	Pump Seal
36100	MS-142	Pump Seal
8256-11	O-2170	ES-7 Gorman Rupp O-ring
AP-304D	MS-1000	Pump Seal
C-10139	O-2262	MS-16 & MS-18 Cover O-ring
C-10146	O-2201	MS-12 to MS-18 O-ring For C10145
C-30082-MS	O-2099	Strainer Cover O-ring
C-46181	O-1019	ES-7 Cover O-ring
C-46251	G-3205	MS 18 Pump Gasket
DP-46350	O-2177	Slide Valve Cover O-ring
DOUGHBOY (SEE LOMART FOR MORE LISTINGS)		
--	MS-2131	Pump Seal
--	R-6131	Power Pak II Pump Repair Kit
--	R-6132	Dynaflow Power Pak I Pump Repair Kit
--	G-4160	New Main Drain Gasket
1128-1006	MS-642	Pump Seal
1128-1006	MS-1000	Pump Seal
306-1002	MS-1000	Pump Seal
306-1005	MS-1000	Pump Seal
306-1006	MS-299	Pump Seal
306-1007	MS-200	Pump Seal
307-1001	G-4425	Gasket
307-1002	G-4131	MX60RP Inlet Fitting Gasket
307-1003	G-3278	Cartridge Gasket
307-1004	G-3212	Cartridge Gasket
307-1005	G-4030	MY205 Skimmer Gasket (For Kit Order 2)
307-1007	G-4305	Skim Filter Drain Cap Gasket
307-1023	G-4220	Deluxe Skimmer 90 Degree Radius Fitting Gasket
307-1027	G-4029	Skim-Line Face Plate Gasket
307-1027	G-4029A	New Style Skimmer Gasket-Wider
308-1000	O-1041	Tank O-ring
308-1001	O-2090	Manifold Seal O-ring
308-1002	O-2255	Lid Bushing O-ring
308-1003	O-2104	Manifold Bearing O-ring
308-1004	O-2240	H&L Pot O-ring
308-1005	O-2017	3/4 HP Pump O-ring
308-1006	O-2134	Piston O-ring
308-1008	O-2226	Valve Body O-ring
308-1009	O-2024	Air Relief Fitting O-ring
308-1010	O-2170	Pump O-ring
308-1011	O-2141	Volute O-ring
308-1012	O-2212	#1110D Tank O-ring
308-1013	O-2205	Pump Discharge O-ring
308-1014	O-2216	1141 & 1162 MY185RP Cartridge O-ring
308-1016	O-2115	Outlet Retainer O-ring
308-1018	O-2401	Manifold Quad Ring
308-1038	O-2041	O-ring
308-1039	O-2152	Hose Adapter O-ring
308-1040	O-2104	Insulator O-ring
308-1046	O-2231	O-ring
308-1052	O-2286	Strainer Body O-ring-1984
308-1054	O-2220	Drain Valve O-ring
308-1056	O-1041	Tank O-ring
308-1059	O-2119	Dynaflow Cover O-ring
308-1061	O-2203	Dynaflow Basket Port O-ring
308-1062	O-2264	Cartridge Filter Coupling O-ring
308-1064	O-2122	O-ring
308-1067	O-2286	Power Pak 2 Lid O-ring
308-1068	G-4043	S-12, 60-4012 Skimmer Gasket
308-1072	G-4425	Gasket
308-1075	O-1012	O-ring
308-1076	G-4250	Gasket
308-1081	G-4201	Valve Cap Gasket

FITS OEM#	SSC#	DESCRIPTION
308-1083	G-4202	Gasket
308-1089	G-4042	DIX Skimmer Gasket
308-1099	O-2041	PPI Diffuser O-ring
308-1109	G-4309	Silica Valve Body Gasket/Washer
308-1110	G-4220	Gasket
308-1113	O-1134	Sand, DE & Silica I Tank O-ring
308-1114	O-1135	Silica II Tank O-ring
308-1115	O-1013	O-ring
308-1124	O-2209	Cyclops Mark 5 O-ring
308-1125	O-2007	Cyclops Strainer Cover O-ring
308-1134	O-2038	Pro X Backwash Valve Cap O-ring
308-1137	O-2146	Lid Bushing O-ring
308-1139	G-4324	Flat Cut Gasket
308-1140	G-5028	2" Inspection Port Ring
308-1141	O-1066	Filter Tank O-ring
308-1142	O-1090	20" Tank O-ring
308-1145	G-4219	Drain to Valve Gasket
308-1146	G-4276	Viewport Lid Gasket
308-1147	G-4241	Viewport Gasket
308-1150	O-2150	O-ring
308-1152	O-2135	Valve Cover Plunger O-ring
308-1156	O-1065	15" Tank O-ring
308-1167	O-2286	Power Pak 2 Lid O-ring
308-1174	O-2200	4 Position Valve Stem O-ring
310-1039	G-3264	Tube to Spin-O-Cycle Gasket
327-1007	G-3281	Friction Washer
348-1033	G-4263	Slinger Washer
MY220-RP	O-1041	Pump Gasket
DURA PLASTICS		
--	O-2100	Union Ball Valve O-ring
DYNAPURE		
D-T1	O-1120	Tank O-ring
EDGEWOOD		
--	G-4003	Inlet Heater Gasket
--	G-4004	Outlet Heater Gasket
ELECTROFEED		
--	O-2239	25 A Fitting O-ring
EQUATOR (KAFKO)		
19-0159-2	G-3037	Face Plate Gasket
19-0552-1	G-3416	Main Drain Face Ring Gasket
ESTER WILLIAMS		
--	G-3189	Port Hole Gasket-Above Ground
E-Z CHLOR		
--	O-2124	Flow Meter O-ring
12690-09	O-2024	Flow Meter Gasket
12690-22	G-4437	Silicone Valve Seal Gasket
12690-26	G-4327	Saddle Fitting Gasket
12883-03	O-1120	DP Tank O-ring
168090	G-4610	Bottom Flowmeter Gasket
168092	O-2082	Top Flowmeter O-ring
824050	G-4600	3/8" Saddle Gasket
824090	G-5075	Bottom Flowmeter Gasket
824090	G-4610	Bottom Flow Meter Gasket
824092	O-2082	Top Flowmeter O-ring
918	O-2519	Flometer Viton O-ring
FIBERSTARS		
A9981	O-2112	Small O-ring
A9982	G-4622	Large O-ring/Gasket

OEM PART# CROSS REFERENCE

FITS
OEM# **SSC#** **DESCRIPTION**

FILTER FLOW

-- G-3214 Body Gasket

FISCHER-PORTER

101W701U01 O-2503 Chlorinator Viton O-ring
 101W704U01 O-2520 Chlorinator Viton O-ring
 101W705U01 O-2521 Chlorinator Viton O-ring
 101W706U01 O-2506 Chlorinator Viton O-ring
 101W707U01 O-2502 Chlorinator Viton O-ring
 101W709U01 O-2512 Chlorinator Viton O-ring
 101W710U01 O-2519 Chlorinator Viton O-ring
 101W711U01 O-2124 Chlorinator O-ring
 101W715U01 O-2515 Chlorinator Viton O-ring
 101W716U01 O-2514 Chlorinator Viton O-ring
 101W718U01 O-2607 Chlorinator Viton O-ring
 101W721U07 O-2614 Chlorinator Viton O-ring
 101W814U01 O-2003 Chlorinator O-ring
 101W816U01 O-2103 Chlorinator O-ring
 101W901U01 O-2609 Chlorinator Viton O-ring
 101W902U01 O-2517 Chlorinator Viton O-ring
 101W903U01 O-2612 Chlorinator Viton O-ring
 101W904U01 O-2510 Chlorinator Viton O-ring
 101W905U01 O-2615 Chlorinator Viton O-ring
 101W910U01 O-2205 Chlorinator O-ring
 101W918U01 O-2608 Chlorinator Viton O-ring
 101W920U01 O-2610 Chlorinator Viton O-ring

FLINT & WALLING

-- G-3133 Sprinkler Pump Gasket
 -- G-3136 Pump Jet Gasket
 126544 MS-201 Pump Seal
 126545 MS-201 Pump Seal
 131100 MS-800 Pump Seal
 132377 MS-800 Pump Seal
 AC-16 MS-800 Pump Seal

GENERAL MAJOR

-- G-3218 Body Gasket

GOULD

-- O-2101 Old Style Turbo Valve O-ring

GRID

-- O-2195 O-ring for 3050, 3051, 3052
 3008 O-2129 Diverter O-ring
 3009 O-2175 Cover O-ring

GUARDEX

25475HYD O-2228 Brominator Lid O-ring
 B-94 O-2228 Brominator Lid O-ring
 P72999 G-4428 Rubber Washer

GULF

34106201 MS-201 Pump Seal
 341064702 MS-2131 Pump Seal
 352501903 O-2266 Power Tech 2 Lid O-ring
 352501904 O-2309 Power Tech 2 Knob O-ring
 352506104 O-2618 Power Tech Diffuser Gasket
 352506230 O-1209 Power Tech Pump Gasket
 352506260 O-1226 Power Tech Cover Gasket
 352507091 O-2041 Power Tech 2 Housing O-ring

H & F

-- O-2218 Pump O-ring
 -- G-3207 Pot to Volute Gasket
 -- G-3256 Volute Gasket

FITS
OEM# **SSC#** **DESCRIPTION**

-- G-3249 Volute Gasket-Thin
 -- MS-1000 Pump Seal

HARMSCO

201 MS-201 Pump Seal
 550 O-1207 11" Rim Gasket/O-ring BF-84, 126 Large
 551 O-2188 Standpipe O-ring
 552 O-2200 Holding Rod O-ring
 635 G-4402 15 Hole Cover Gasket
 636 G-4403 15 Hole Cover Gasket
 639 G-4334 Cover Gasket
 671 G-4404 27 Hole Cover Gasket
 783 O-2165 2 1/2" O-ring
 784 O-2189 2 1/8" O-ring
 930 O-2002 Holding Rod O-ring For BF96/BF144
 Cartridge Filter

HAYWARD

-- O-1030 Goldmarc Model 181 & 241 Cover O-ring
 -- O-2221 Center Rod O-ring
 -- F-8101 GM Series Sand Filter O-ring Kit
 -- F-8102 Pro Series Plus Sand Filter O-ring Kit
 -- F-8103 Sand Filter (S-160T) O-ring Kit
 -- F-8104 Sand Filter (S-200) O-ring Kit
 -- F-8105 Sand Filter (S-240) O-ring Kit
 -- F-8106 Sand Filter (S-245T, S-190T) O-ring Kit
 -- F-8201 EC-65 & EC-75 Perflex DE Filter O-ring Kit
 -- F-8202 Micro Clear S. St. DE Filter O-ring Kit
 -- F-8203 EC-40 & EC-50 Perflex DE Filter O-ring Kit
 -- F-8204 Micro Clear Dura., Perma., DE Filter O-ring
 Kit
 -- F-8301 Super Star Clear Cartridge Filter O-ring Kit
 -- F-8302 Star Clear II Cartridge Filter O-ring Kit
 -- F-8303 Star Clear Cartridge Filter O-ring Kit
 -- F-8304 Micro Star Clear Cartridge Filter O-ring Kit
 -- F-8305 Super Star Clear C-3000S & C-4000S
 O-ring Kit
 -- F-8306 Star Clear Plus Cartridge Filter O-ring Kit
 -- R-6101 Max-Flo 1800-2800 Pump Repair Kit
 -- R-6102 Super II Pump Repair Kit
 -- R-6103 Super Pump Repair Kit
 -- R-6104 Powerflo-Clear Cover-Pump Repair Kit
 -- R-6105 Powerflo-Solid Cover-Pump Repair Kit
 -- R-6106 SP-1250 Cast Iron Pump Repair Kit
 -- R-6115 SP710X/711 '69-'75 5 Spoke Multiport
 Repair Kit
 -- R-6116 SP710/711 '69-'75 6 Spoke Multiport
 Repair Kit
 -- R-6117 Turboflo 2000-2100 & Powerflo 1500
 Repair Kit
 -- R-6118 Powerflo 1700 Pump Repair Kit
 -- R-6148 SP-410X Slide Valve Repair Kit
 -- O-2223 Cartridge Filter Center Rod O-ring
 -- R-6158 CL200 Chlorinator Repair Kit
 -- G-4645 Super Pump Drain Plug Gasket
 -- VP-697 Straight Connector for Skimmer Vacuum
 Plate
 -- VP-698 Elbow Connector for Skimmer Vacuum
 Plate
 -- R-6174 Northstar Pump Repair/Service Kit
 CCX1000G O-2395 Body O-ring for Xstream Cartridge Filters
 CCX1000Z5 K-6023 O-ring Kit for Gauge Adapter and Air Relief
 Valve
 CLX0110K O-2504 Chlorine Feeder Viton O-ring
 CLX0200K O-2511 Chlorinator Viton O-ring
 CLX0200LA K-6003 Chlorinator O-ring Kit
 CX0120D O-2095 Cartridge Filter Lid O-ring
 CX0250F O-1215 250, 500 & 750 Tank O-ring
 CX0250Z6 O-2223 O-ring

OEM PART# CROSS REFERENCE

FITS			FITS		
OEM#	SSC#	DESCRIPTION	OEM#	SSC#	DESCRIPTION
CX0250Z7	O-2116	Locking Knob Cartridge Filter O-ring	SPX0125Z3	G-5003	Volute Pump Diffuser Ring
CX0400G	O-2307	Cover O-ring	SPX0145G	G-3168	Pump Gasket
CX0800F	O-1054	800 and 1100 Cartridge Filter O-ring	SPX0145T	G-5009	Pump Lid Gasket
CX0900F	O-2306	Filter Head O-ring	SPX0409C2	G-3173	Fitting Gasket (For Kit Order 2)
CX0900H	O-2239	Star Clear Plus O-ring	SPX0410Z1	O-2008	SP410X Piston O-ring-Small
CX25003Z2	G-4111	Gasket	SPX0410Z2	O-2150	SP410X Large Piston O-ring
CX25005B1	G-3017	Gasket	SPX0501HJ	K-6002	Light Lens O-ring Set
DEX0360E	O-2186	Bulkhead Fitting O-ring	SPX0505G	G-3132	Shell Assembly Gasket
DEX0360K	O-1099	Micro Clear DE Vertical S/S Filter Tank O-ring	SPX0506D	G-3165	Niche Gasket
DEX0360M	O-2199	Bulkhead Fitting O-ring	SPX0508BA	G-3215	Cover Gasket Only
DEX2400K	O-1001	Micro Clear Vertical Fiberglass Tank O-ring	SPX0540Z2	G-5126	Light Lens Gasket
DEX2400S5	G-4212	Micro Clear Filter Relief Valve Tank Gasket	SPX0577Z1	G-4110	Deck Box Cover Gasket
DEX2400Z3A	O-2253	Micro Clear DE O-ring	SPX0602F	G-4121	Gasket
DEX2400Z5	O-2106	Outlet Elbow O-ring	SPX0602Z2	O-2141	Valve O-ring
DEX2420Z8A	K-6020	Swimclear Cartridge Filter O-ring Kit	SPX0603F	G-4103	Cover Gasket
ECX1003	G-5153	DE Diaphragm Gasket for EC-30, 40, 50- With Holes	SPX0603Z2	O-2133	Stem O-ring
ECX1014	E-6600	Bump Shaft Retainer C-Clip for Perflex DE Filter	SPX0603Z2	G-5142	Valve Teflon Piece With Split
ECX1105	G-5152	DE Diaphragm Gasket for EC-65, 75-No Holes	SPX0605F	G-4112	Cover Gasket
ECX1287	O-2105	DE Filter Gauge O-ring	SPX0605Z2	O-2261	Stem O-ring
ECX1321A	O-2090	Micro Star Air Relief Valve O-ring	SPX0605Z2	G-5142	Valve Teflon Piece With Split
ECX270091	103009PL	Gauge	SPX0605Z2V	O-2515	Drain Plug O-ring-Viton
ECX270811	103009PL	Gauge	SPX0704F	O-2128	1 1/2" Vari-Flo Cover O-ring
ECX270861	103015PL	Gauge	SPX0710D	G-5108	6 Spoke Spider Gasket (Prior to 1977)
ECX27091	103009PL	Gauge	SPX0710R	G-4280	Multiport Valve Sight Glass Gasket
ECX2899A	O-2124	Perflex Pump Shaft O-ring, Small O-ring	SPX0710XD	G-5106	5 Spoke Spider Gasket (After 1977)
ECX9611246	O-2135	EC Filter Bump Shaft O-ring	SPX0710XZ3	O-2128	Vari-Flow Lid O-ring (After 1976)
GMX0142C8	O-2122	O-ring	SPX0710XZ5	O-2128	Housing O-ring for Powerflo Matrix Pump
GMX0142DA2	G-4460	Sand Filter Gasket	SPX0710Z1	G-3277	Non-Metallic Bearing Gasket
GMX0142Z2	O-2188	Pump O-ring	SPX0710Z14	G-3277	Non-Metallic Bearing Gasket
GMX0152Z5	O-2116	Drain Plug O-ring (After 1979)	SPX0710Z16	G-3277	Non-Metallic Bearing Gasket
GMX0400D	G-3185	GM-400 Multiport Gasket	SPX0710Z3	O-2025	Valve Lid O-ring (Prior to 1976)
GMX0400F	O-2164	Valve to Tank Lid O-ring	SPX0712	O-2160	Vari Flo Pipe Socket O-ring
GMX0400P	O-2248	Flange Mount Valve Stem O-ring	SPX0714L	O-2266	Cover O-ring for Variflo XL Valve
GMX0600D	O-2144	Teflon Bearing Washer O-ring	SPX0715Z1	O-2067	Multiport Valve Cover O-ring
GMX0600F	O-2058	Filter Tank Lid O-ring	SPX0722G	O-2155	Ball Valve End Connector O-ring
GMX0600FST	O-1095	Threaded Filter/Valve Lid O-ring	SPX0722H	O-2124	Stem O-ring (Prior to 1975)
GMX0600P	O-2248	GM-600 Valve O-ring	SPX0723	120292	PVC Single Union Ball Valve-1 1/2" FIP x 1 1/2" MIP Nipple End
RGX0045G	O-1144	Regenex Filter Head O-ring	SPX0723S	120290	PVC Single Union Ball Valve-1 1/2" Socket x 1 1/2" MIP Nipple End
SCR-420	SCR-420	1 1/4" Long Skimmer Screws-12/Pack	SPX0724G	O-2117	End Connector O-ring
SFX0400Z1	O-2001	Large Drain Valve O-ring	SPX0727K	O-2243	Valve O-ring
SFX0400Z1	O-2001	Large Drain Valve O-ring	SPX0728H	O-2243	End Connector O-ring
SPSTX0266Z5B	O-2025	Hair and Lint Strainer O-ring-320, 325, 320R, 325R	SPX0733Z1A	O-2242	Valve Key O-ring
SPSTX0269Z5B	O-2022	Hair and Lint Strainer O-ring-304, 340R	SPX0733Z2A	O-2339	O-ring for Dial-A-Flow Filter
SPSTX0305F	G-4332	1 1/2" In Line Trap Cover Gasket	SPX0733Z2A	O-2329	O-ring For Diverter Valve
SPSTX0315Z1	G-4273	2" In Line Trap Cover Gasket	SPX0735G	O-2256	Valve Stem O-ring
SPSTX0325F	G-4272	3" In Line Trap Cover Gasket	SPX0735GA	K-6001	Vari Flo Valve O-ring Kit
SPSTX0330Z1	G-4269	4" In Line Trap Cover Gasket	SPX0735H	O-2280	Ball Valve Connector O-ring
SPSTX0335Z1	G-4270	5" In Line Trap Cover Gasket	SPX1019	GC-495	Gutter/Deck Drain Complete
SPSTX0340Z1	G-4218	6" In Line Trap Cover Gasket	SPX1019BA	GC-490	Replacement Grate With Screws For Socket Gutter/Deck Drain
SPSTX0345H	G-4264	8" In Line Trap Cover Gasket	SPX1022B	WP-21	Flush Plastic Winterizing Plug with O-ring
SPX0045	LP-275	1/2" Loop Type Hook-Chrome Plated Brass	SPX1022C	O-2115	Seal Plug O-ring
SPX0047	LP-276	3/4" Loop Type Hook-Chrome Plated Brass	SPX1022C	WP-20	Raised Plastic Winterizing Plug with O-ring
SPX0058D	G-3131	Main Drain Gasket	SPX1022INS	RF-489	Concrete Pools Insider Fitting
SPX0071C2	G-4328	Sight Glass Gasket (For Kit Order 2)	SPX1022S	RF-482	Gunite Pool I/O Fitting-1 1/2" Socket x 2" MIP
SPX0072C2	G-4261	Gasket	SPX1023	RF-481	Vinyl Pool I/O Fitting-1 1/2" FIP
SPX0072Z4	O-2208	Sight Glass O-ring	SPX1023S	RF-483	Vinyl Pool I/O Fitting-1 1/2" Socket-Extended Length
SPX0084M	G-3016	Skimmer Gasket	SPX1023Z12	G-4290	Return Fitting Gasket
SPX0090E	G-3018	Skimmer Gasket	SPX1023Z3	G-3242	Inlet/Outlet Washer/Gasket-Fiber
SPX0099E	G-3019	Skimmer Gasket	SPX1023Z3	G-4638	Inlet/Outlet Washer/Gasket-Rubber
SPX0102Z32	G-4214	Gasket	SPX1025Z1	G-4299	Return Fitting Gasket
SPX0125F	G-4227	Motor Shaft Slinger Gasket	SPX1025Z12	G-4259	SP-1025 Gasket (For Kit Order 2)
SPX0125G	G-3166	Pump Gasket	SPX1025Z3	G-3262	SP-1025 Filter Slip Washer
SPX0125H	G-3219	Pump Gasket	SPX1026	RF-487	Grate Insert for Pool Wall Outlets
SPX0125T	G-5039	Pump Lid Ring	SPX10301C	SCR-420	1 1/4" Skimmer Screws-Package of 12
SPX0125Z2	MS-372	Pump Seal	SPX1035B	G-4243	SP-1035 AV Main Drain Gasket

OEM PART# CROSS REFERENCE

FITS			FITS		
OEM#	SSC#	DESCRIPTION	OEM#	SSC#	DESCRIPTION
SPX1035C	G-3262	SP-1035 AV Main Drain Fiber Sealing Slip Gasket	SPX1432E	G-4260	Jet Air Mini Jet Gasket
SPX1039C2	G-3137	Fitting Gasket (For Kit Order 2)	SPX1433S	JA-572	Jet Air Fitting Kit
SPX1040	RA-574	Rope Anchor With Steel Pin	SPX1434J	O-2096	Vari Flo Nozzle O-ring
SPX1048B	MF-457	Vinyl Pool Main Drain Sealing Frame Ring	SPX1434L	G-4249	Jet Air III Gasket
SPX1048D	G-3170	Main Drain Vinyl Gasket-Fiber	SPX1434TP	O-2134	O-ring
SPX1048D	G-4116	Main Drain Vinyl Gasket-Rubber	SPX1434TP	WP-22	Test Plug for Pressure Testing
SPX1058D	G-3124	Main Drain Gasket	SPX1438H	O-2098	Pro Jet O-ring
SPX1070B	MF-458	Skimmer Cover Adjusting Collar for 1070	SPX1438J	G-4229	Pro Jet Gasket
SPX1070C	SC-492	Round Cover	SPX1441Z1	O-2141	Valve Stem O-ring
SPX1070Z1	O-2122	Float Valve O-ring	SPX1450G	G-4636	Turbo Boost Spa Jet Jumbo Return Fitting Gasket
SPX1070Z2	O-2049	Float Valve O-ring	SPX1450M	O-2023	Turbo Boost Winter/Test Plug O-ring
SPX107242	G-4306	Gasket	SPX1480	U-561	Union
SPX1082CA	BA-691	In Ground Skimmer Basket for 1084, 1085	SPX1482	U-565	Flush Union
SPX1082E	SC-491	Square Skimmer Cover	SPX1483C	O-2231	Valve Union O-ring
SPX1082Z410	O-2090	Star Clear Relief Valve O-ring	SPX1484	U-563	Male Union
SPX1082Z5B	O-2252	Powerflo Volute O-ring (Before 1986)	SPX1485	U-562	Self Aligning Double Male End Union With End Sweep
SPX1084B	G-4065	Skimmer Gasket for 1084-Rubber	SPX1485B6	O-2195	Union Elbow O-ring
SPX1084B	G-3020	Skimmer Gasket-Fiber	SPX1485C	G-5033	Sand Filter Elbow Ring
SPX1084B3	G-3014	SP-1084-OM Gasket	SPX1491B	O-2020	Econo Union O-ring
SPX1084F	SF-451C	1084 Skimmer Faceplate Cover	SPX1493	U-560	Econo Union
SPX1084L	SF-451	Skimmer Faceplate to fit 1084 Skimmers	SPX14953S	U-564	Flush Union
SPX1084P1	EC-573	Extension Collar	SPX1495Z1	O-2040	Ball Valve Flush Union O-ring
SPX1084Z4A	SCR-410	1" Skimmer Screws-Package of 12	SPX1500H	G-3125	Pump Gasket-Fiber
SPX1085B	SF-452	Widemouth Skimmer Faceplate	SPX1500H	G-4119	Pump Gasket-Rubber
SPX1085D	G-3001	Skimmer Gasket-Fiber	SPX1500KA	MS-2131	Pump Seal
SPX1085D	G-4064	Skimmer Gasket for 1085-Rubber	SPX1500LX	BA-694	Powerflow Pump Basket-Large-1992 to Present
SPX1085F	SF-452C	1085 Widemouth Skimmer Faceplate Cover	SPX1500M	O-2104	SF400 Small Drain Valve O-ring
SPX1090D	SF-450	Skimmer Faceplate for 1090 Skimmers	SPX1500N	O-2282	O-ring
SPX1090E	G-3006	Vinyl Skimmer Gasket-Fiber	SPX1500P	O-2007	Power Flow Pump Lid O-ring
SPX1090E	G-4001	Vinyl Skimmer Gasket-Rubber	SPX1500RA1	G-4422	Pump Check Valve Gasket
SPX1090WMSG	G-4066	Skimmer Gasket for Above Ground Widemouth (for kit order 2)	SPX1500W	O-2152	Strainer Connector O-ring
SPX1091Z7	HA-460	Hose Adapter-1 1/2" MIP X 1 1/4" & 1 1/2" Hose	SPX1500X	G-3268	Pump Gasket
SPX1094G	G-4041	Skimmer Gasket-Rubber	SPX1580Z1	O-2209	Powerflo Housing O-ring
SPX1094G	G-3002	Skimmer Gasket-Fiber	SPX1600M	BA-693	Super Pump Basket
SPX1096CA	BA-690	Above Ground Skimmer Basket for 1090	SPX1600R	O-2618	Super Pump Diffuser Gasket
SPX1097E	G-3003	Skimmer Gasket-Fiber	SPX1600S	O-1226	Super Pump Lid Gasket
SPX1097E	G-4067	Skimmer Gasket for 1097-Rubber	SPX1600T	O-1209	Super Pump Gasket
SPX1099E	G-3026	1099 Skimmer Gasket-Fiber	SPX1600Z2	MS-201	Pump Seal
SPX1104-1	VP-696	Small Skimmer Vacuum Plate-For Above Ground	SPX1700FG	G-4267	Washer
SPX1107-1	VP-695	Large Skimmer Vacuum Plate-For Inground	SPX1705Z1	O-2143	Pump Housing O-ring
SPX1250G	G-3128	Pump & Mounting Bracket Gasket	SPX1905E	O-2185	Self Drain Pump Housing O-ring
SPX1250RA	BA-692	Powerflo Pump Basket-1992 & Prior	SPX2551-300	RF-488	Insert Inlet-3/4" Eyeball Opening
SPX1250XZ2	MS-200	Pump Seal	SPX3000S	O-2247	SP3000 Pump Lid O-ring
SPX1408	RF-480	Vinyl Pool I/O Fitting-1 1/2" FIP x 1 1/2" FIP	SPX3000SV	O-2518	Chlorinator Cover Viton O-ring
SPX1408B	RF-455	Return Fitting Faceplate to Fit 1408 Fitting	SPX3000T	O-1217	Super II Pump Housing Gasket O-ring
SPX1408C	G-4134	Vinyl Eyeball Gasket	SPX3500K	O-2618	Super Spa Pump Diffuser Gasket
SPX1411B	RF-456	Threaded Return Faceplate	SPX4000T	O-2047	Seal Plate O-ring for Northstar Pump
SPX1411Z12	G-4124	Gasket for SP-1411, 1407-1	SPX4000TS	O-2307	Cover O-ring/Gasket for Northstar Pump
SPX1418D	RF-486	Directional Flow Fitting with Extended Flange-3/4" Opening	SPX4000Z1	O-2355	Diffuser O-ring/Gasket for Northstar Pump
SPX1419A	DF-485A	Directional Flow Outlet Fitting-Slotted Sweep Opening	SPX5500H	O-2286	Lid to Housing O-ring for Powerflow Matrix A/G Pump
SPX1419B	DF-485B	Directional Flow Outlet Fitting-3/8" Directional Stream	SPX5500K	O-2100	Strainer O-ring for Powerflow Matrix A/G Pump
SPX1419C	DF-485C	Directional Flow Outlet Fitting-1/2" Directional Stream	SX0160Z1	O-1049	Sand Filter Tank O-ring
SPX1419D	DF-485D	Directional Flow Outlet Fitting-3/4" Directional Stream	SX0180G	G-4443	Sand Filter Gasket
SPX1419E	DF-485E	Directional Flow Outlet Fitting-1" Directional Stream	SX0200Z14	O-2261	1980 O-ring
SPX1419T	ST-358	Plastic Eyeball Seat Removal Tool	SX0200Z3	O-2270	Filter O-ring
SPX1425S	RF-484	Floor Inlet Fitting	SX0200Z4	O-2165	S-160 & S-240 Sand Filter O-ring
SPX1425Z6	O-2195	EC-65 Inlet Fitting O-ring	SX0200Z5	O-2133	Filter O-ring
			SX0200Z6	O-2091	Sand Filter Lid O-ring
			SX0200Z7	O-1106	S-200 Filter Tank O-ring
			SX0200Z9	G-4325	Sand Filter Drain Gasket
			SX0220Z2	O-2056	Bulkhead Fitting O-ring
			SX0220Z3	O-2282	Pro Filter O-ring
			SX0240Z1	O-1044	Sand Filter Tank O-ring
			SX0360Z1	O-2355	O-ring

OEM PART# CROSS REFERENCE

FITS			FITS		
OEM#	SSC#	DESCRIPTION	OEM#	SSC#	DESCRIPTION
HERCULES SPA PACKS (DIV. OF JACUZZI)			HYDROTECH		
1370097	G-4055	Skimmer Gasket	25475	G-5077	Lid Ring
605100	MS-200	Pump Seal	25475HYD	O-2228	Brominator Lid O-ring
755314	O-2346	O-ring	B154	G-4319	Brominator Air Vent Gasket
760502	O-2020	Heater Element O-ring	B94	O-2228	Brominator Lid O-ring
HOMELITE			HYPRIME		
62363-A	G-4223	Gasket	--	O-2020	Small Impeller O-ring
62665-A	G-4234	Impeller Housing Gasket	--	O-2040	Large Impeller O-ring
62772	O-2079	O-ring	--	O-2128	Lid O-ring
75911-A	MS-201	Pump Seal	--	O-2165	Pot to Volute O-ring
HUSTLER			--	O-2195	Impeller O-ring
A111	O-2141	Small O-ring	INTERNATIONAL		
A211	O-2239	Large O-ring	--	O-2066	Manifold O-ring
HYDREL			--	O-2124	Crank O-ring
8092-S	G-5131	Lens Gasket	--	O-2254	Collection Tube O-ring
HYDRO (SEE ALSO PENTAIR/PAC FAB)			--	O-2255	Lower Piston O-ring
--	MS-201	Pump Seal	--	G-3254	Bonnet Flange Gasket
PO-0050	O-2079	Dynamic Pump Volute O-ring	6291-9	O-1121	Tank O-ring
HYDRO AIR			6721-9	O-1122	Tank O-ring
--	O-2006	ADI Flowjet O-ring	JACUZZI		
--	O-2051	Air Control O-ring	--	O-2006	Collection O-ring
10-027EP70	O-2321	Butterfly Jet O-ring	--	O-2080	U25B Lid O-ring
10-2204	G-4370	Air Control Valve Gasket	--	O-2115	4 Way Valve Upper O-ring
10-3705	G-4366	Air Control Valve Gasket	--	O-2259	Plastic Multiport Stem O-ring
10-3804	G-4244	Wall Fitting Gasket	--	F-8114	Laser Sand Filter O-ring Kit
10-3953	O-2053	Jet Assemblies O-ring	--	F-8216	Landslide DE Filter, DE Sep. Tank O-ring Kit
10-5008	G-4380	Whirlpool & USR Jet Gasket	--	F-8315	CFR Cartridge Filter O-ring Kit
10-5834	O-2144	Mark II Jet Assembly O-ring	--	F-8314	CFR 25 Cartridge Filter O-ring Kit
10-5847	G-4343	Mark II Jet Assembly Gasket	--	F-8322	Tri-Clops & Earthworks Cart. Filter O-ring Kit
10-5857	O-2195	O-ring	--	R-6119	Magnum Pump Repair Kit
10-6003	G-4377	Adjustable Skimmer Gasket	--	R-6120	R and RC Series Pump Repair Kit
11-3429	O-2195	O-ring	--	R-6147	LR Series Pump Repair Kit
11-3449	O-2165	Union O-ring	--	G-3182	Filter Gasket
11-3469	O-2226	O-ring	--	R-6160	PJM Pump Repair Kit
16-5004	G-4048	Hydr'ssage Cannister Gasket	--	R-6162	ULSB & ULSC Pump Repair Kit
16-5523	G-4142	Thera'ssage Gasket	--	R-6166	SLPH, SLTPH, LCU, etc., Pump Repair Kit
16-5623	G-4047	Verta'ssage Backing Plate Gasket	--	R-6167	LPH, LPC, LTPH, LH & LTH Pump Repair Kit
HYDRO QUIP			--	R-6165	PH & UPH Pump Repair Kit
60-0001	O-2086	Heater Element O-ring	--	R-6168	P, PC, EP Series Pump Repair Kit
61-0001	G-4396	Heater Union Gasket	--	R-6164	8M & 10M Pump Repair Kit
61-0011	G-4358	1 1/2" Heater Union Gasket	--	R-6163	Cygnets Pump Repair Kit
HYDROPUMP (SEE ALSO PENTAIR / PAC FAB)			--	R-6161	J, JCM, K & KM Pump Repair Kit
--	O-2121	5" H & L Trap O-ring	--	F-8119	MFM 17, 20, 24 Sand Filter O-ring Kit
--	O-2247	6" H & L Trap O-ring	--	F-8120	RMST-24, ST27, ST33 Sand Filter O-ring Kit
--	G-3135	560-700 Series Gasket	--	F-8218	Earthworks DE Filter O-ring Kit
--	G-3178	400 Pot to Volute Gasket	01-0990-00	G-4046	JWB Whirlpool Gasket
--	G-3127	650 Pump Gasket	01-3610-09	E-6505	Pump/Motor Shaft Extension
--	G-3140	Pump Sweep Motor Gasket	10-0002-06	MS-200	Pump Seal
400	G-3161	Pot to Volute Gasket	10-0420-00	MS-201	Pump Seal
511	G-3207	Pot to Volute Gasket VB20	10-0476-00	MS-200	Pump Seal
HL4	O-2086	4" H&L Trap O-ring	10-0477-00	MS-201	Pump Seal
VB2	G-3160	Volute Gasket-200 Series VB2	10-0478-00	MS-359	Pump Seal
VB20	G-3207	511 Pot to Volute Gasket	10-0479-00	MS-358	Pump Seal
VB40	G-3159	Volute Gasket	10-0486-00	MS-201	Pump Seal
HYDROSTORM PUMP (SEE CARETAKER)			10-0487-00	MS-201	Pump Seal
			10-0506-00	MS-359	Pump Seal
			10-0563-00	MS-162	Pump Seal
			10-1202-00	MS-359	Pump Seal
			10-1203-01	MS-877	Pump Seal
			10-1203-19	MS-877	Pump Seal
			10-1390-04	MS-201	Pump Seal

OEM PART# CROSS REFERENCE

FITS			FITS		
OEM#	SSC#	DESCRIPTION	OEM#	SSC#	DESCRIPTION
10-1436-00	MS-200	Pump Seal	47-0112-00	O-2024	Stem & Crank O-ring
10-1462-07	G-4310	Eye Seal Gasket	47-0112-99	O-2024	Plug O-ring
10-1502-09	MS-201	Pump Seal	47-0115-07	O-2102	S/W Injector O-ring
13-0006-09	G-4141	Vinyl Return Fitting Gasket	47-0116-05	O-2220	Valve O-ring
13-0007-08	G-3038	Standard Throat Gasket	47-0116-30	O-2220	Dial Valve O-ring
13-0010-03	G-3001	Skimmer Gasket-Fiber	47-0117-05	O-2220	Shaft O-ring
13-0011-02	G-3406	2" Plug Gasket	47-0118-04	O-2242	S/W Injectors O-ring
13-0013-00	G-3407	1 1/2" Plug Gasket	47-0123-07	O-2264	RM2 Injector Cap O-ring (As of 11/91)
13-0014-09	G-4052	Gasket	47-0126-04	O-2131	DB3 Sleeve O-ring
13-0015-08	G-4623	Return Flange Gasket	47-0129-01	O-2020	Skimmer Mat O-ring
13-0061-01	G-3216	Pump Gasket	47-0131-07	O-2009	Gyro Flo O-ring
13-0090-06	G-4434	Pump Flapper Gasket	47-0139-09	O-2106	TP4 Test Plug O-ring
13-0136-02	G-4433	Flange Gasket	47-0142-04	O-2199	2" Valve O-ring
13-0150-02	G-3216	VB-21 Gasket	47-0143-03	O-2049	2" Multiport Valve O-ring (After 8/73)
13-0178-01	G-4410	U Pump Gasket	47-0144-02	O-2234	2" Multiport Valve O-ring (Prior to 8/73)
13-0191-04	G-3176	Gasket	47-0161-00	O-2212	DA1A-DA1B Case O-ring
13-0192-03	G-3172	Gasket	47-0165-06	O-2295	D83 Case O-ring For DB1 Pump
13-0220-09	O-1010	Flange O-ring	47-0175-04	O-2373	SC Series Case O-ring
13-0221-08	O-1125	Flange O-ring	47-0212-09	O-2256	RM2, 3 S/W Injector O-ring
13-0239-08	G-4427	5-Way Valve Gasket	47-0212-66	O-2264	O-ring
13-0243-02	G-3154	Gyromat Valve Gasket	47-0213-08	O-2221	S/W Injection Plug O-ring
13-0244-01	G-4203	Filter Gasket	47-0214-07	O-2264	Valve Stem O-ring
13-0273-05	G-3138	4 Way Valve Gasket	47-0214-49	O-1073	Earth Works Filter O-ring
13-0275-03	G-4252	4-Way Valve Gasket	47-0216-05	O-2255	Verturi O-ring
13-0277-01	G-3217	4 Way Valve Gasket	47-0218-11	O-2203	Air Control O-ring
13-0300-02	G-4230	Flange Gasket	47-0218-45	O-2203	Air Control O-ring
13-0301-01	O-1055	Tank Clasp O-ring	47-0220-09	O-2142	Test Plug O-ring-TP1
13-0314-06	G-3202	Pump Gasket-Fiber	47-0221-08	O-2020	4 Way Valve Disc Body O-ring
13-0314-06	G-4186	Pump Gasket-Rubber	47-0222-07	O-2020	PM Filter Valve O-ring
13-0329-09	G-4125	Gasket	47-0222-07	G-4265	PM Filter Valve Gasket
13-0377-00	G-5027	Multiport Valve Gasket	47-0222-68	O-2165	Splash Pak O-ring
13-0378-09	G-5023	5-Way Valve Gasket	47-0223-06	O-2231	Filter Valve O-ring
13-0379-08	G-4450	PJM Flange Gasket	47-0224-05	O-2115	PM Filter Valve O-ring
13-0411-08	G-3012	Face Plate Gasket For Wide Mouth Skimmer	47-0226-03	O-2195	Inlet Fitting Seal O-ring
13-0414-05	G-4223	Cartridge Filter Tube Gasket	47-0227-02	O-2040	Gyro-Flo O-ring
13-0417-02	O-1116	Cartridge Filter Cover O-ring	47-0227-36	O-2040	Gyromat B/W Lower Valve O-ring
13-0428-09	O-1123	SS-24 Filter Tank O-ring	47-0228-01	O-2165	Jet Charger 225 A, B, C O-ring
13-0462-06	G-3026	SV, SL Skimmer Gasket	47-0228-35	O-2165	Gyromat B/W Upper Valve O-ring
13-0463-05	G-3171	SL Skimmer Suction Fitting Gasket	47-0228-68	O-2165	Union O-ring
13-0864-00	G-4152	Main Drain Gasket	47-0229-00	O-2226	O-ring
13-0872-06	G-4258	Valve Gasket	47-0232-54	G-5031	Magnum Diffuser Square Ring
13-0877-05	G-3198	Gasket	47-0233-04	O-2015	H4 Booster O-ring
13-0878-04	G-3021	Flange Gasket	47-0236-01	O-2025	Splash Pak Valve Cover O-ring
13-0880-00	G-4102	M/V Gasket	47-0240-05	O-2219	O-ring
13-0881-09	G-5041	Underdrain Gasket	47-0248-56	G-5026	Dial Valve Square Ring
13-0888-02	G-3171	5-Way Valve Gasket	47-0251-01	O-2252	Press Molder Lint Catcher O-ring
13-1020-09	G-4369	HT & WHJ Jet Gasket, Valve Gasket	47-0254-08	O-2211	Flo Pro O-ring
13-1021-08	G-4399	Fitting Gasket	47-0255-07	O-2346	DVK-7 O-ring
13-1022-07	G-4447	Laser Sand Gasket	47-0256-06	O-2041	PM Filter Valve O-ring
13-1023-06	G-4459	CFR Gasket	47-0257-05	O-2143	Separation Tank Support O-ring
13-1075-03	G-4618	2" Valve Gasket	47-0258-04	O-2209	O-ring
13-1207-04	G-4151	Main Drain Gasket	47-0258-53	G-5060	L Series (After 5/88), CFT & RPZ Square Ring
13-1223-04	G-3153	Gasket	47-0258-61	G-5035	L Series Pump Square Ring
16-0920-12	G-5035	XL-VII Pump Ring	47-0262-08	O-2089	O-ring
17-0228-68	O-2165	Union O-ring	47-0264-06	O-2146	5-Watt Valve O-ring
20-1010-00	O-2024	RTC Pump O-ring	47-0268-02	O-2034	PM Filter Top O-ring
42-2927-06	O-1101	Dial Valve & Sandtrap Filter Adapter Valve O-ring	47-0326-02	O-2134	Sand Trap Plug O-ring
47-0008-07	O-2222	CFR Air Vent O-ring (Prior 1/88)	47-0328-00	O-2008	Splash Pak O-ring
47-0013-00	O-2248	Drain Plug O-ring	47-0331-05	O-2009	O-ring
47-0016-05	O-2220	1 1/2" Valve O-ring	47-0347-07	O-2240	Gyromat O-ring
47-0016-06	O-2220	Filtromat Cover O-ring	47-0348-06	O-2272	Multiuse Pump & Filter O-ring
47-0020-01	O-2257	K Series Filtromat O-ring	47-0349-06	O-2086	PJM Cap O-ring
47-0021-00	O-2288	Air Control Valve Seat O-ring	47-0352-41	O-2059	Lid O-ring
47-0022-09	O-2205	Shaft Sleeve O-ring	47-0353-08	O-2139	O-ring
47-0028-03	O-2254	Filter Valve O-ring	47-0353-40	O-2139	Strainer Cover O-ring
47-0080-76	O-2222	O-ring	47-0354-07	O-2007	U Series Pump O-ring
47-0106-08	O-2153	CFR Vent O-ring	47-0355-06	O-2236	1 1/2" Sandtrap Filter Lid O-ring
47-0110-02	O-2090	Valve & Filter O-ring	47-0355-48	O-2236	PH Series Cover O-ring
			47-0357-04	O-2266	Pump Lid O-ring

OEM PART# CROSS REFERENCE

FITS OEM#	SSC#	DESCRIPTION
47-0357-46	O-2266	JC Pump Housing O-ring
47-0358-03	O-2224	Magnum Pump O-ring (After 7/89)
47-0358-50	G-5023	Square Cut O-ring
47-0359-02	O-2224	PM Filter Valve O-ring
47-0360-09	O-2095	CFT 25 Filter O-ring
47-0361-08	O-2300	RP3 Case O-ring
47-0361-48	O-2300	Cygnat O-ring
47-0364-05	O-2058	Dial Valve O-ring
47-0364-47	O-2058	Magnum Pump Housing O-ring
47-0370-07	O-2278	2" Multiport Valve O-ring
47-0371-06	O-2387	CE Body O-ring
47-0380-47	O-2181	CFT Cover O-ring
47-0386-62	O-2181	Fat Boy O-ring
47-0433-02	O-2172	Filtromat O-ring
47-0433-51	O-2266	USLB 6" Lid O-ring
47-0434-01	O-2080	Magnum Pump Lid O-ring Prior to 7/89
47-0438-07	O-2247	Cast Iron Pump Lid O-ring
47-0439-06	O-2054	Cast Iron PJM Lid O-ring
47-0442-01	O-2094	H&L Strainer O-ring
47-0443-00	O-2293	Sandtrap Filter V/A O-ring
47-0448-05	O-1010	O-ring
47-0462-06	G-5046	Square Diffuser Gasket
47-0463-05	G-5035	F Series Pump Square Seal Ring
47-0464-04	O-2094	2" DV Cover O-ring
47-0465-03	O-2256	Diverter Dial Valve O-ring
47-0466-02	G-5016	Strainer and Case Gasket
47-0467-01	O-2226	Dial Valve O-ring
47-0569-99	O-1015	Earth Works Tank O-ring
47-6172-04	O-2374	Top O-ring for Sandstorm 31 Filter
91-9341-82	103009PL	Gauge
94-1104-67	G-3022	SV Basic Skimmer Face Gasket
JANDY (DIVISION OF LAARS)		
--	O-2124	Leaf Trap O-ring
1132	O-2175	Vinyl Cover O-ring
1307	O-2220	Shaft O-ring
2300	O-2003	Porpoise Hydrotimer Case O-ring
2614	O-2125	Energy Filter Bowl O-ring
2644	G-4063	Valve Actuator Gasket
3293	O-2125	Sheer Descent Cover O-ring
3381	O-2155	Space Saver Valve O-ring
4487	G-4401	Vac Floor Gasket
6749	O-2049	Valve O-ring
R0338200	MS-601	Pump Seal
R0338700	O-2146	High Head Pump Body O-ring
R0338801	O-2100	Diffuser O-ring
R0338900	O-2224	Pot Lid O-ring
R0339600	O-2002	Coupling Set O-ring (For Kit Order 2)
R0340400	O-2214	Medium Head Body O-ring
R0350600	O-1160	C Series Cartridge Filter Tank O-ring
R0353400	O-2390	CT Series Cartridge Filter Lid O-ring
R0354400	G-4634	SF-S Sand Filter Half Union Gasket
R0357800	O-1161	CL Series Cartridge Filter Tank O-ring
JOHNS MANVILLE		
--	O-2125	Johns Manville & Amitek O-ring
K-D POOLS		
10-0002-06	MS-200	Pump Seal
13-0378-09	G-5023	Sand Filter Square Ring Gasket
13-1023-06	G-4459	Cartridge Filter Gasket
47-0106-08	O-2153	Cartridge Filter O-ring
47-0112-00	O-2024	Sand Filter O-ring
47-0258-53	G-5060	LR6 Gasket
47-0352-41	O-2059	LR6 Strainer Cover O-ring
47-0357-46	O-2266	K Square Ring
47-0380-47	O-2181	Cartridge Filter O-ring

FITS OEM#	SSC#	DESCRIPTION
KAFKO (SEE EQUATOR)		
KDI PARAPORT (SEE ALADDIN)		
KIM		
--	O-2100	Rear Seal O-ring
--	O-2018	Lens O-ring
KING (KINGFEEDER / KINGTECH)		
--	O-2116	Kingfeeder Cam O-ring
01-22-1920	O-2523	New Water Cap O-ring, B-192 Series 100/200 Cap O-rng
01-22-1926	O-2088	Cap O-ring
01-22-7850	G-4038	King Tech Scoop Gasket
01227856	G-4038	Scoop Gasket
01-22-7856	G-4038	Scoop Gasket
01-22-9426	O-2214	Body O-ring ('91 & Prior)
01-22-9926	O-2224	Cap O-ring (Current)
106-000-016	O-2049	King Tech New Style Cap O-ring
106-100-007	O-2137	King Tech Old Style Cap O-ring
106-100-008	O-2155	Cam O-ring
106-100-019	O-2243	Basket O-ring
119	O-2137	Old Style Cap O-ring
122	O-2049	King Feeder Cap O-ring
192	O-2523	New Water Cap Viton O-ring
722	O-2243	Basket O-ring
746	O-2155	Cam O-ring
942	O-2209	King Tech Body Cap O-ring-Perform.
943	O-2516	King Feeder Performax Drain Plug Viton O-ring
945	O-2006	King Feeder Control Dial O-ring Kit
992	O-2224	400/430, 940 Cap O-ring
KREEPY KRAULEY (DIV. OF PENTAIR)		
12-800	O-2231	Swivel Housing O-ring
12866	G-4401	Universal Pool Cleaner Floor Gasket
LAARS (TELEDYNE LAARS)		
--	O-2102	Control Well O-ring
--	G-3235	Round By-Pass Gasket
--	G-4016	2 Button Command Center Face Plate Gasket
--	G-4210	Aqua Dyne Round Gasket
--	G-4315	Large Tube Round Gasket
--	G-4326	Small Tube Round Gasket
--	G-5048	Tube Late Style Gasket
--	G-4316	Washer
225	G-4303	3/16" Thick Washer
E-1164	G-5066	Gasket/O-ring
E-244	G-4442	Heater Gasket
E-325	G-3245	Heater Gasket
E-327	G-3274	Heater Gasket
E-363	O-2223	Heater O-ring
E-376	G-3025	Heater Gasket
E-516	G-3252	Thermostat Cover Gasket
F-111	G-3280	Heater Gasket
R00114	G-4612	By-Pass Valve, Flow Control Gasket
R0011400	G-5057	H1-E2 Heater By-Pass Valve Gasket
R03275	G-4463	Header Gasket
R0338805	O-2117	Diffuser O-ring-3 HP
R-508	G-5063	Header Gasket
S00531	G-5151	Heater Flange Gasket
S-055	G-4027	Heater Gasket
S-056	G-4315	Large Tube Round Gasket
S-056P	G-4316	Aqua Dyne Heater Washer
S-057	G-4326	Tube Round Gasket
S-057P	G-4303	Aqua Dyne 3/16" Thick Washer

OEM PART# CROSS REFERENCE

FITS OEM#	SSC#	DESCRIPTION
S-151	G-4262	Heater Gasket
S-152	G-5048	Aqua Dyne Late Style Tube Gasket
S-154	G-5057	Flange Gasket
S-156	G-4304	Heater Gasket
S-157	G-4211	Heater Gasket
S-159	G-4286	Heater Gasket
S-245	G-4017	Heater Gasket
S-246	G-4024	Heater Gasket
S-248	G-4020	Heater Gasket
S-328	O-2208	Heater O-ring
S-606	G-5005	Heater Tube Gasket
S-690	O-2008	Heater O-ring
S-700	G-4037	Temp Control Gasket
S-702	G-5004	Heater Washer
S-708	G-5005	Heater Washer
S-735	O-2283	O-ring
S-737	G-4340	Tank Cover Gasket
S-741	G-5057	Flow Control Gasket (For Kit Order 3)
S-987	G-5149	Jacket Hole Plug

LANDON

--	O-1127	Stainless Steel Tank O-ring
--	O-2008	Spin 1 1/2" Collection O-ring
--	O-2218	Pump Lid O-ring
--	O-2115	Backwash O-ring
--	O-1063	Separation Tank O-ring
--	O-2082	Crank Shaft O-ring
--	O-2002	2" Spin Collection O-ring

LASCO

--	O-2155	2" PVC Union O-ring
--	O-2189	1 1/2" PVC Union O-ring
--	O-2378	Old Style O-ring for 1 1/2" Sch. 80 Union
--	O-2379	Union O-ring

LEN GORDON

--	G-4016	Face Plate Gasket
----	--------	-------------------

LESLIE'S

SPX0710Z3	O-2025	Hydramax A/G O-ring
SPX1500KA	MS-2131	Hydramax A/G Seal
SPX1500W	O-2152	Hydramax A/G Strainer O-ring
SPX1600R	O-2618	Hydramax II Diffuser Gasket
SPX1600Z2	MS-201	Hydramax II Seal
SPX1705Z1	O-2143	Hydramax A/G Housing O-ring
SPX3000S	O-2247	Hydramax II Cover O-ring
SPX3000T	O-1217	Hydramax II Housing Gasket

LETRO

F-31	O-2003	Hose Assembly O-ring
JV-11	O-2369	Jet Vac O-ring
JV-18	O-2124	Jet Vac O-ring
JV-29	G-4391	Jet Vac Gasket
LA-08	MS-200	Pump Seal
LA1000	MS-1000	Pump Seal
LA-375	O-2253	Booster Pump Drain Plug O-ring
LA-40	G-5119	End Bell Gasket
LA-415	O-2089	Booster Pump O-ring
LD-10	G-5043	Hose Washer
LE-43	O-2220	Turbo Sweep O-ring
LF-07	O-2082	O-ring
LF-24	O-2135	O-ring
LG-12	O-2208	O-ring
LG-32	O-2263	O-ring
LJ-04	O-2144	O-ring
LL-13	O-2365	Housing Body O-ring
LL-14	O-2024	Gear Assembly O-ring
LLC140	O-2124	Thrust Jet O-ring

FITS OEM#	SSC#	DESCRIPTION
LLU6	O-2242	Feedmast O-ring
LLU7	O-2242	Feed Mast O-ring
P-40	O-2024	Hose Assembly O-ring

LIFEGUARD (SEE RAINBOW)

LITTLE GIANT

101601	G-4435	Impeller Housing Gasket
102601	G-4454	Volute Gasket-No. 2
103601	G-4457	Volute Gasket
928007	G-5067	Square Cut Ring
928024	G-5071	Gasket
928028	G-5065	Terminal House Gasket

LOCHINVAR

GKT-2400	G-4056	Heat Shield Gasket
----------	--------	--------------------

LOMART

(SEE DOUGHBOY FOR MORE LISTINGS)

--	O-1063	Separation Tank O-ring
--	O-2002	Spin 2" Coll. O-ring
--	O-2082	Crankshaft O-ring
--	O-2115	Backwash Valve O-ring
--	O-2218	Pump Lid O-ring
--	K-6005	Backwash Plunger Pipe O-ring Kit
--	MS-150	Pump Seal
040-024	G-3209	Body Gasket
040-027	MS-142	Pump Seal
040-027	MS-163	Pump Seal
040-028	MS-142	Pump Seal
040-029	MS-163	Pump Seal
042-024	G-3180	Body Gasket
043-013	G-3143	Body Gasket
046-029	G-4263	Gasket
047-015	MS-1000	Pump Seal
047-016	MS-1000	Pump Seal
053-014	O-1051	13" Tank O-ring
053-015	O-1052	14" Tank O-ring
053-019	O-2135	Shaft O-ring
053-026	O-2020	Strainer O-ring
053-029	G-4309	Valve to Tank Gasket
053-044	O-2038	Back Wash Cap O-ring, Pro Pump Diffuser O-ring
053-047	G-3264	Gasket
053-049	O-2135	Valve Cover Plunger O-ring
053-050	O-2134	Backwash Valve O-ring
053-058	O-2121	Strainer Cover O-ring
053-074	O-1058	16" Tank O-ring
053-075	O-2051	Tube O-ring
053-097	O-1066	14" Tank O-ring
053-101	O-2127	O-ring
053-110	O-1064	11" Tank O-ring
053-120	G-4276	Viewport Lid Gasket
053-131	O-1119	Tank O-ring
053-132	O-2209	Cyclops Mark 5 O-ring
053-133	G-4219	Gasket
053-140	G-4241	Viewport Gasket
053-146	O-1124	24" Tank O-ring
053-157	G-4201	Gasket
053-159	O-2007	Strainer O-ring
053-174	O-1090	Tank O-ring
053-180	O-2146	Pro Pump O-ring
053-185	O-2150	O-ring
053-200	O-2095	Pro Pump Cover O-ring
053-210	O-1129	O-ring
053-211	G-4324	Gasket
053-213	O-1065	Tank O-ring

OEM PART# CROSS REFERENCE

FITS	OEM#	SSC#	DESCRIPTION
	053-215	G-5028	Ring
	1121-1057	MS-200	Pump Seal
	304	MS-1000	Pump Seal
	307-1023	G-4373	DIX Skimmer Return Gasket
	308-1068	G-4043	S-12, 60-4012 Skimmer Gasket
	308-1078	O-2089	Spectra II, Ultima II Valve to Tank O-ring
	308-1089	G-4042	DIX Skimmer Gasket
	308-1115	O-1013	Tank O-ring to fit Ultra D.E. Filter
LUITWEILER			
--	O-2119		Pump Lid O-ring
--	O-2218		Pump O-ring
--	G-3101		Old Style Pump Gasket
--	G-3102		Large 4 Hole Gasket
--	G-3108		Pump Volute Gasket
--	G-3120		New Style Pump Gasket
--	G-3152		Small 4 Hole Gasket
--	MS-201		Pump Seal
MAGIC VALVE			
	0301-226	O-2189	1 1/2" Union O-ring
	0301-227	O-2270	2" Union O-ring
MARINE			
--	O-2024		Valve Stem O-ring
--	O-2115		Valve Cap O-ring
--	O-2121		5" Clear Plastic H&L Lid O-ring
--	O-2134		Valve Piston O-ring
--	O-2142		Valve Piston O-ring
--	O-2228		5" Clear Lid O-ring
--	O-2261		Old Style Crank O-ring
--	G-4298		DE Spin Filter Shaft Sleeve Gasket
1150	O-2264		Locknut O-ring
1160	G-4418		Bushing Cup Gasket
1220	G-4322		Flat Rubber Bushing Gasket
1340	O-2417		990MS & BH Filter Quad Ring
1350	O-2402		990MS & BH Filter Quad Ring
15151	MS-358		Pump Seal
1560	O-2189		Deck Filter Manifold O-ring
1560	G-5129		V Cup O-ring-Square Cut
1600	O-1080		Tank O-ring
166-6	O-2222		Thermometer O-ring
3660	G-4238		Flat Rubber Gasket
3760	O-1077		Tank O-ring
5260	O-1039		Tank O-ring
5280	O-2068		Bearing & Manifold O-ring
5740	O-1090		MS Tank O-ring
624-5	O-1131		Sand Filter Tank O-ring
7650-3	O-1069		6 3/4" Clear Pump Lid O-ring
7700	MS-1000		Pump Seal
9524	MS-703		Pump Seal
99-8088-5	G-5055		Small Separation Tank Ring
99-8660-5	G-5024		Large Separation Tank Gasket
MARLOW			
--	O-2020		Diffuser 1/3-1 HP Mardur Pump O-ring
--	O-2100		H Series 2 HP Diffuser O-ring
--	O-2112		Diffuser O-ring
--	O-2155		Mardur Pump Diffuser O-ring
--	G-3024		34 EC-15D Tank Cover Gasket
--	G-3106		34EC-15D Tank Gasket
--	G-3174		34EC-15D Pump Inlet Gasket
--	G-4277		AF Pump Cover Gasket (All Models)
--	G-5040		1-2 HP AF Pump Diffuser Gasket
--	G-3105		2112 8-Hole Large Cover Gasket
--	G-3266		VP-153 Strainer Body Gasket
15621	G-5073		AF Diffuser Gasket-1-2 HP
186862	BP-386		Pump Seal for L Stockline

FITS	OEM#	SSC#	DESCRIPTION
	21034	G-3103	Tank to Lantern Gasket
	21035	O-2100	AF Diffuser O-ring-3 HP
	22991	G-3111	Motor to Lantern Shim Gasket
	23112	G-3166	H Series Pump Housing Gasket
	23736	MS-411	Pump Seal
	25353	MS-411	Pump Seal
	25475	O-2100	H Diffuser O-ring-2 HP
	25476	G-5017	3/4 & 1 1/2 HP H Series Pump Diffuser Gasket
	25784	G-5007	Pump Cover Gasket
	26144	G-5069	H Diffuser Gasket-3/4 to 1 1/2 HP
	26467	MS-411	Pump Seal
	26469	MS-406	Pump Seal
	26588	G-3224	Discharge Gasket
	26661	MS-406	Pump Seal
	27223	MS-416A	Pump Seal
	28484	G-4231	AF Series Pump Slinger Gasket-All Models
	28983	G-5074	H Diffuser Gasket-1/3 & 1/2 HP
	29038	G-5019	Pump Gasket
	30156	O-2140	1/2 & 1/3 HP Series Pump Diffuser O-ring
	32540	G-5078	AF Strainer Cover Gasket
	37478	G-5014	Mardur 1/3 to 1 HP Pump Cover Gasket
	37479	G-5010	Mardur Strainer to Tank Gasket (All Models)
	37482	G-5052	Mardur Pump Seal Plate Gasket
	38592	MS-201	Pump Seal
	39404	G-5016	1 1/2 & 2 HP Mardur Pump Seal Gasket
	40478	O-2189	Gemini O-ring
	42925	O-2118	Gemini O-ring
	43117	O-2040	Argonaut Diffuser O-ring
	44308	O-2167	Argonaut Cover O-ring
	44802	O-2094	Argonaut Bracket O-ring
	470400	G-3415	4 SPC Gasket
	471210	G-3414	4 SPC Gasket
	P48690	G-3404	L Stockline Pump Volute Gasket
	VP-153	G-3266	Strainer Body Gasket
MARTEC (SONFARREL)			
	201-002	O-2220	Bleed Plug O-ring
	201-004	O-2041	Filter Body O-ring
	201-010	O-2024	Drain Plug O-ring
	202-003	G-4382	Suction Filter Flange Gasket
	205-104	O-2024	Bleeder O-ring
	205-106	O-2294	Filter Head O-ring
	300-004	O-2025	Wet End O-ring
	300-009	MS-1000	Pump Seal
	310-104	O-2252	Booster Pump O-ring
	310-108	MS-1000	Pump Seal
	320-102	O-2167	Trap Lid O-ring
	320-108	G-4033	Flange Gasket
	320-110	O-1082	Pool Master Housing O-ring
	320-119	MS-201	Pump Seal
	400-102	G-4352	DS Filter, JM Jet Gasket
	400-108	O-2242	Reed Valve O-ring
	410-504	O-2053	O-ring
	410-506	G-4353	Bath Jet Gasket
	410-511	O-2195	Bathmaster Jet Body O-ring
	420-509	G-4341	BJ 5000 Gasket
	420-512	G-3181	Eyeball Teflon Piece
	610-112	G-4036	FAS Skim Filter Gasket
	700-103	O-2195	Union O-ring
	700-203	O-2226	Sonfarrel 2" Union O-ring
	700-308	O-2226	2" Tailpiece O-ring
	700-408	O-2115	1 1/2" O-ring for Tail
MASTER			
	08490-0031	G-4635	Master Turbo Clean Head Square Ring Seal

OEM PART# CROSS REFERENCE

FITS OEM#	SSC#	DESCRIPTION
MEC-O-MATIC		
88004-73	K-6004	HJ & Barracuda O-ring Kit
MIAMI TANK		
--	O-1008	20" CF-104 Tank O-ring
--	O-1126	FG18 & FG24 Lid O-ring
CF-52	O-1055	16" Tank O-ring
MISCELLANEOUS GASKETS		
--	G-4128	Light Deck Box Gasket
--	G-4228	2" Fire Hose Gasket
--	G-4237	3" Discharge Hose Flat Washer
--	G-4237	3" Fire Hose Gasket
--	G-4240	Fire Hose Coupling Gasket
--	G-4449	2" Discharge Hose Flat Washer
--	G-4461	Oval Rope Eye Gasket
--	G-4222	3" Quick Disconnect Fitting Gasket
--	O-2343	O-ring for Commercial Sand Filter
MONARCH		
--	O-2040	Old Time Impeller O-ring
--	O-2231	New Style Impeller O-ring
--	O-2270	Pump to Volute O-ring
--	G-3104	Pump Gasket
197989	O-1128	D7 O-ring
199696	G-4222	Seal Gasket
MUSKIN		
--	O-2133	4 Way Valve Shaft O-ring
--	O-2414	4 Way Valve Seat Quad Ring
--	MS-150	Pump Seal
009-2001	MS-163	Pump Seal
037-3408	G-3273	Drain Cap Gasket
037-3410	O-1039	18" Tank O-ring
037-3412	O-2605	Blue Teflon Coated Strainer Pump Lid O-ring
037-3414	O-2134	Valve O-ring
037-3417	G-5053	Body Ring
037-3430	O-1106	20" Tank O-ring
037-3434	O-1041	16" Tank O-ring
037-5002	G-4281	Air Relief Valve Assembly Gasket
037-5071	G-4226	Grid Post Gasket
038-3410	G-4415	Drain Cap Washer
038-3416	G-4323	Tank Tube Valve Gasket
038-3421	G-4331	Spin Filter Gasket
038-3424	G-4288	Tank Gasket
038-3432	G-3225	Viewport Gasket
038-3439	G-3232	Jet Stream Tank Gasket
038-3446	G-4439	Adapter Gasket
038-3457	G-4328	Valve Body Gasket-Flat
038-3457	G-4424	1 1/2" Backwash Cap Gasket-Solid
038-3458	G-4014	Skimmer Gasket
038-5434	O-2134	O-ring
098-7235	G-4001	Skimmer Gasket-Rubber
098-7235	G-3006	Skimmer Gasket-Fiber
101-6910	G-3231	Vinyl Washer
15-4713	G-4640	Drain Gasket
19-2115	O-2261	Drain Plug O-ring
27-2511	O-2082	Diverter Shaft O-ring
275-0007	O-2346	6 Position Valve Cover O-ring
54003	G-4418	Valve Waste Cap Gasket
54004	G-4385	3/4" Washer
54005	G-3193	FP Pump, Drain Fitting Gasket
54006	G-3194	Air Relief Bushing Gasket
54007	G-3235	Tank to Valve Inside Washer
54008	G-5001	Clamp Nut Gasket
54009	G-3230	Viewport Gasket
54010	G-4294	Viewport Gasket

FITS OEM#	SSC#	DESCRIPTION
54011	G-3150	Self Priming Pump Housing Gasket
54012	G-3122	5 Position Valve Gasket
54013	G-4384	Vac Attach Skimmer Gasket
54014	G-3145	Discharge Fitting Gasket
54015	G-3022	Skimmer Faceplate Gasket
54016	G-3192	Backwash Valve Outside Tank Gasket
54017	G-3269	Valve Cover Gasket
54018	G-3004	A-4372 & A-4372F Skimmer Gasket
54019	G-5062	Cartridge Housing Gasket
54020	G-3191	Backwash Valve Cap & Pos. Valve Gasket
54021	G-3195	Mylar Resin Tank Gasket
54022	G-3196	Resin Tank Gasket
54023	G-3190	Thru Wall Return Gasket
54024	G-3035	Mini Skimmer Gasket
54027	G-4218	8" HMLI Tank Gasket
54028	G-4061	Skim Filter Body Gasket
54029	G-4613	Discharge Fitting Intake Gasket
54040	O-2420	5 Position Valve Quad Ring
54048	MS-163C	Seal Ceramic
54055	G-3403	Tank Gasket
54061	O-1034	Tank Gasket
54062	O-2133	Axle & Valve Shaft O-ring
54063	O-2104	Spider O-ring
54064	O-2086	Strainer Pump Lid O-ring
54065	O-2146	9" Plastic Tank O-ring
54066	O-1102	15" Tank Lid O-ring
54067	O-2256	FP Parker Pump O-ring
54068	O-1147	11" Tank O-ring
54069	O-1148	18" Resin Tank O-ring
54071	O-2007	Hair & Lint Pot O-ring
54072	O-2020	Filter O-ring
54076	G-3405	Poly Element Filter Gasket
54078	O-2242	Small O-ring
54079	O-2128	Large Filter O-ring
72008	MS-142	Pump Seal
72031	O-1146	15" Metal Tank O-ring
72032	O-1149	14" Metal Tank O-ring
72033	O-2146	9" Plastic Tank O-ring
72034	K-6012	Cartridge Housing Gasket/O-ring Kit
72035	K-6014	3 Position Valve Gasket Kit
72036	K-6015	5 Position Valve Gasket Kit
72037	K-6019	Fill Port Gasket Kit
72038	K-6017	Standard Skimmer Gasket Kit
72039	K-6016	DLX Skimmer Gasket Kit
72040	K-6018	Resin 5 Position Gasket/O-ring Kit
72198	O-2266	Valve Top O-ring
72201	O-2012	Valve Bottom O-ring
72209	O-2391	Filter Head Cover O-ring
A-4372	G-3004	Skimmer Gasket
A-4372F	G-3004	Skimmer Gasket
MYERS		
11416-A	MS-101	Pump Seal
NATURE 2		
2-13035	O-2381	Model G Purifier Inlet O-ring
2-13061	O-2091	Cap O-ring
2-13073	O-2249	Cap O-ring
OLYMPIAN		
--	F-8107	Sand Filter O-ring Kit

OEM PART# CROSS REFERENCE

FITS			FITS		
OEM#	SSC#	DESCRIPTION	OEM#	SSC#	DESCRIPTION
OLYMPIC (AQUALEADER)			--	F-8214	2000 Series Sand Filter O-ring Kit
ACM-83	G-3006K	Gasket Set	--	F-8308	50, 80, 100 S/F Mytilus & Mitra Cartridge O-ring Kit
ACM-83C	G-4059	Rubber Skimmer Gasket (For Set Order 2)	--	F-8309	60 S/F Mitra Cartridge Filter O-ring Kit
ACM-94-5	O-2292	Chlorinator Cover O-ring	--	F-8310	Mytilus 80, 100, 150S/F Cart. Filter O-ring Kit
ACM94-7	O-2208	Chlorine Feeder Valve O-ring	--	F-8311	Mytilus B Reinforced Cart. Filter O-ring Kit
ACM-97G	G-3402	Main Drain Gasket	--	F-8312	Mitra S.S Cartridge Filter O-ring Kit
GAS-1096-G	G-4054	Widemouth Gasket for ACM96 Skimmer	--	R-6107	2" Slide Valve Repair Kit
WP-83W	G-4058	Regular Gasket for Widemouth Skimmer	--	R-6108	Challenger Pump Repair Kit
OMNI			--	R-6121	Dynamo, Dynamite, Dynatron Pump Repair Kit
G-5960	O-2282	Chlorinator O-ring	--	R-6137	Universal Slide Valve Repair Kit
ONYX			--	R-6138	Hydro Pump Repair Kit
ON15	G-4338	1 1/2" Spa Union Gasket	--	R-6139	Pinnacle Pump Repair Kit
ON20	G-4339	2" Spa Union Gasket	--	O-2024	Crankshaft O-ring
ONHSUPREME	G-5150	Spa Pack Gasket	--	O-2220	Crankshaft O-ring
ORTEGA (SEE PUREX)			--	O-2028	5" H & L Trap O-ring
PAC FAB (SEE PENTAIR)			--	O-2282	Nautilus Lower Pipe Assembly O-ring
PADDOCK			--	F-8217	Nautilus S/S DE Filter O-ring Kit
--	O-1225	Clamp Type & Combination O-ring	02-112	O-2024	Crankshaft O-ring
--	O-2008	Petite Spin Filter Tube O-ring	02-116	O-2220	Crankshaft O-ring
--	O-2133	Petite Spin Filter Crank O-ring	07-0951	G-4398	Tube Seal Gasket
--	O-2231	Star Clear Tube & Manifold O-ring	07-1725	MS-360	Pump Seal
--	G-4233	1 1/4" - 1 1/2" Flat Gasket	07-4015	G-4455	Flow Valve Gasket
--	G-4248	2" Flat H&L Gasket	07-4629	G-4386	Commercial R Gasket
--	G-4254	Trimmer Lid Keyhole Gasket	07-5846	O-2387	Commercial R Seal Plate O-ring
--	G-4287	3/4" Sight Glass Gasket	07-5847	O-2389	Commercial R Lid O-ring
PARAPORT			--	O-2139	Commercial R Diffuser O-ring
C64057	O-2141	Bleeder Adapter O-ring	15-2038	O-1056	22" Tank O-ring
C64069	G-4388	Sight Glass Gasket	15-2038-2	O-1087	Tank O-ring
PEERLESS			15-2038-3	O-1085	Tank O-ring
--	G-3116	4 Hole Bracket to Pot Gasket	15-2122	O-2068	O-ring
--	G-3211	2 Hole Pot to Volute Gasket	15-2127	O-1062	18" Tank O-ring
--	G-3257	Bracket to Pot Round Gasket	15-2235	O-1071	16" PF-100 Tank O-ring
2665554	MS-162	Pump Seal	15-2501	O-2217	Valve Adapter O-ring-TA100D
PENTAIR / PAC FAB			15-2509	G-5079	Square Gasket
(SEE ALSO AMERICAN PRODUCTS, KREEPY KRAULY, PUREX AND RAINBOW)			15-4004	O-2283	Triton C-3 Filter O-ring
--	O-1031	9/16" X 67 1/2" Tank O-ring	15-4005	O-2114	C-3 O-ring
--	O-1045	O-ring	15-4287	O-2102	Valve Shaft O-ring
--	O-2032	8" Trap Lid O-ring	15-4491	O-2100	1 1/2" Bulkhead O-ring
--	O-2102	Crankshaft O-ring	15-4492	O-2282	2" Bulkhead O-ring
--	O-2106	Nautilus Manifold O-ring	15-4493	O-2041	Filter Dome Lid O-ring
--	O-2106	PVC Backwash Valve Cap O-ring	15-4494	G-5076	Square Ring
--	O-2106	RPZ Pot to Volute O-ring	15-4495	O-2041	Triton II Closure O-ring
--	O-2106	Mark Series Center Pipe O-ring	15-4538	G-4324	2" Bulkhead Fitting Gasket
--	O-2256	Multiport Valve Shaft Seal O-ring	15-4539	G-4296	1 1/2" Super Flow B/H Gasket
--	G-3127	Hydro 650 Model Pump Gasket	15-4661	O-2141	Gauge & Air Bleeder Adapter
--	G-3134	Hydro VB-40 Volute Gasket	15-4693	O-2376	Knob O-ring
--	G-3135	Hydro 560-700 Series Gasket	15-4713	G-4295	Sand Drain Gasket-15"
--	G-3140	Hydro Pump Sweep Motor Gasket	15-4827	O-2133	Air Relief O-ring
--	G-3178	Hydro 400 Model Pot to Volute Gasket	15-5050	103015PL	Gauge
--	G-3263	Washer	15-5064	O-2189	Tagelus Stand Pipe O-ring
--	F-8108	Fiberglass Sand Filter O-ring Kit	15-5564	O-2189	Star O-ring
--	F-8110	PF 35/30 S. St. Sand Filter O-ring Kit	17-4704	O-1048	Mytilus/Turbo Tank O-ring
--	F-8111	PF 100 S. St. Sand Filter O-ring Kit	17-5680	O-2200	Drain Port O-ring
--	F-8112	Tagelus Fiberglass Sand Filter O-ring Kit	17-5687	O-2261	Air Relief Valve O-ring
--	F-8211	Star DE Filter O-ring Kit	17-8568	O-2392	DM Tank/Cartridge O-ring
--	F-8212	400 Series DE Filter O-ring Kit	19-1424	O-2071	Star 40/ Mytilus Bottom Piping O-ring
			19-1474	O-2115	Star DE Filter O-ring
			19-1479	O-2256	Star DE Filter Shaft O-ring
			19-1517	O-2066	Star 50 DE Standpipe O-ring
			19-2031	G-4282	Crankshaft Sleeve Flat Gasket
			19-2032	G-4291	Gasket
			19-2039	O-2220	SCS Spin Filter Crank O-ring
			19-2040	O-2264	Crank Cap O-ring
			19-2115	O-2082	RM Spin Filter Crank O-ring
			19-2122	O-2150	1 1/2" Return Filter O-ring
			19-2300	O-2106	Mytilus Connector & Bulkhead O-ring

OEM PART# CROSS REFERENCE

FITS OEM#	SSC#	DESCRIPTION
19-2320	O-2215	Stainless Steel DE Filter O-ring, Bulkhead O-ring
19-2323	O-2106	Filter & Pump Gasket
19-2404	G-4265	SCS Return Sleeve Gasket
19-5004	G-4015	Poly Gasket
19-5007	O-2219	4" Diameter Adapter O-ring
19-5008	O-1037	Old Style Tank Lid O-ring
19-5310	O-1100	Filter Tank O-ring
27-1103	O-2025	Valve Cover O-ring
27-1104	G-5106	Spider Gasket for 1 1/2" Valve
27-1106	G-4362	Mounting Valve Sight Glass Gasket
27-1148	G-5120	Spider Gasket-5 Spoke
27-1151	O-2374	Cover O-ring
27-1162	O-2256	Valve Stem O-ring
27-2406	O-2124	2" Hi-Flow Valve Shaft O-ring
27-2511	O-2261	1 1/2" Hi Flow Shaft O-ring
27-2541	O-2292	Valve Body O-ring TA30/35/40/50/60
27-2707	O-2253	1 1/4" Hi Flow Valve Knob O-ring
27-2708	O-2059	Filter Top O-ring/Valve Body O-ring
27-3004	G-3234	Screw Type Valve Cap Gasket
27-3011	O-2024	Brass Valve Shaft O-ring
27-3012	G-5111	1 1/2" Old Style Piston Seal
27-3059	G-5114	2" Piston Seal Ring
27-3060	O-2090	2" PVC Valve Shaft O-ring
27-3062	O-2040	2" PVC Valve Cap O-ring
27-3090	O-2068	2" Slide Valve O-ring
27-3097	G-3271	Brass Backwash Valve Cap Gasket
27-3160	G-5112	1 1/2" New Style Piston Seal
27-3512	O-2302	Nautilus Air Bleeder O-ring
27-3513	O-2302	Air Bleeder Screw O-ring
27-3514	O-2303	Stainless Steel Sand Filter O-ring
27-4494	O-2008	Valve Adapter O-ring
27-5300	O-2332	Full Flow Valve O-ring
27-5333	O-2091	Valve Body O-ring TA100D
31-3225	O-1070	Mitra 11" Tank O-ring
34-4001	MS-201	Pump Seal
35-0002	MS-201	Pump Seal
35-0013	O-2060	Challenger High Pressure Pump Lid O-ring
35-2600	O-2080	Old Style 700 Lid O-ring, Hydro O-ring
35-2600	O-2172	New Style 700 Pump Lid O-ring, P Series Lid O-ring
35-2602	O-2028	New Style 5" H & L Trap O-ring
35-2602	O-2408	Old Style RPZ 590 5" Pump Lid Quad Ring
35-2604	O-2028	590 Glass Pump Lid O-ring
35-2626	O-2262	Backwash Valve O-ring/Volute O-ring
35-2627	G-4104	Backwash Valve Gasket Replaces 35-3500
35-3500	G-3177	Hydro Pot to Volute Gasket-Fiber
35-3500	G-4122	Hydro Pot to Volute Gasket-Rubber
35-3501	G-3107	Hydro B/V Pump Gasket
35-3502	G-3117	540 Pump Gasket
35-3506	G-3112	460-650 Pump Gasket
35-3512	G-3241	880-881 Pot Flange Gasket
35-3513	G-3121	880-881 Pot to Volute Gasket
35-3514	G-3109	880-881 Bracket to Volute Gasket
35-3515	G-3110	Backwash Valve Pump Gasket
35-3525	O-2080	New Style Porpoise Clear Lid O-ring
35-3525	O-2224	Old Style Porpoise Filter Clear Lid O-ring
35-3750	E-6504	Pump/Motor Shaft Extension
35-4001	MS-201	Pump Seal
35-4052	O-2121	540 Pump Lid O-ring
35-4053	O-2266	700 Glass Pump Lid O-ring
35-4533	O-2139	Dynamo, Dynamite Cover O-ring
35-4535	O-2214	Dynamo Bracket Diffuser O-ring
35-4545	MS-200	Pump Seal
35-4571	O-2195	Dynamo Adapter O-ring
35-4634	O-2286	Bracket Diffuser O-ring-After 12/93
35-4894	MS-201	Pump Seal
35-5030	O-2409	MH Challenger Diffuser Quad Ring
35-5329	O-2046	Old Style Challenger Housing O-ring

FITS OEM#	SSC#	DESCRIPTION
35-5329	G-5061	New Style Challenger Front Housing Square Ring
35-5330	O-2226	Challenger Pump Strainer Pot Flange O-ring
35-5331	O-2015	Challenger Diffuser O-ring
35-5332	O-2080	New Style Challenger Pump Lid O-ring
35-5332	O-2172	Old Style Challenger Pump Lid O-ring
35-5619	O-2294	Pinnacle Seal Bracket O-ring
51-3033	G-4031	Skimmer Gasket
51-6231	G-3008	Bermuda Skimmer Gasket
55-2471	G-3400	Liner Sealing Rim Gasket
55-2566	G-3020	Skimmer Gasket-Fiber
61-4562	G-4616	Washer
63-4568	G-3163	Vinyl Pool Niche Gasket
67-0018	G-3155	Spa Vinyl Niche Gasket
88-500-1	G-5129	Old Style Manifold V-ring (SCS Series Before 1977)
88-500-3	G-5136	Large Manifold V-ring
HL4	O-2240	4" H&L Trap O-ring
HL6	O-2247	Hydro 6" H&L Trap O-ring

PLASTILINE

--	O-2100	1 1/2" Union O-ring
--	O-2203	3/4" Union O-ring
--	O-2282	2" Union O-ring

POLARIS

--	R-6172	3/4 HP Booster Pump Repair/Service Kit for 180, 280, 380
6-412	O-2329	Vac Sweep O-ring
6-505-00	O-2004	O-ring UWF/QD
9-100-5108	O-2287	Hose Nut, Cuffless Hose O-ring
9-100-5132	O-2098	Timer O-ring
9-100-5139	O-2134	Wall Bushing O-ring
9-100-5140	O-2001	Filter Housing O-ring
C-140	O-2124	Thrust Jet O-ring
D-24	O-2144	Quick Connect O-ring
E-30	O-2175	Backup Valve Case O-ring
E-31	O-2175	Backup Valve O-ring-1986-91
E-45	O-2024	Backup Valve Plate O-ring
G-58	K-6022	O-ring Kit for 280
P-40	O-2024	Pump Shaft O-ring
P-55	MS-1000	Pump Seal
P-95	O-2209	Volute O-ring

POOL TENDER

05-009-1005	O-2124	O-ring for All Models
-------------	--------	-----------------------

POOLCO

16TPG	103015PL	Pressure Gauge for Filters
16TVT	O-2094	Valve to Tank O-ring for Filters
1XL FP	O-2223	Air Relief Plug O-ring for Cartridge Filter
2XLXLV BHOR	O-2025	Pump Housing O-ring
2XLXLV SEAL	MS-200	Pump Seal
3XL SCOR	O-2007	Strainer Cover O-ring for Vortex Pump
3XL SOR	O-2341	Threaded Strainer 1 1/2" O-ring for Vortex Pump
65CW FHOR	O-2294	Filter Head O-ring
65CW PLUG	WP-20	Threaded 1 1/2" Plug with O-ring
9CP 111-01	O-2350	End Cap O-ring for Filters

POOLSWEEP (SEE ALSO ARNESON)

E-43	O-2220	Turbo Sweep O-ring
G-32	O-2263	O-ring
J-04	O-2144	O-ring
W-430	O-2011	Leaf Cannister O-ring

OEM PART# CROSS REFERENCE

FITS OEM#	SSC#	DESCRIPTION
PRAHER		
T15-E3	O-2211	Cover O-ring
T15-E6	O-2134	Diverter O-ring
PREMIER		
--	O-2068	2" Backwash Valve Valve O-ring
--	O-2122	550 Noryl Bracket O-ring
--	O-2124	Spin Filter Crank O-ring
--	O-2124	Shaft Extension O-ring
--	O-2142	Premier 1 1/2" Cap O-ring
--	O-2226	Large & Spa II O-ring
--	O-2249	550 6" Lid O-ring
--	O-2604	550 Blue Teflon Coated 6" Lid O-ring
--	R-6146	555 Noryl Pump Repair Kit
--	E-6502	Pump/Motor Shaft Extension
--	O-2024	Crank O-ring
--	O-2115	1 1/2" Valve Cap O-ring
--	R-6170	756 Series Pump Repair Kit
--	R-6171	355/225 MK2 Pump Repair Kit
122	G-4322	Rubber Washer
21-108	G-4207	Rubber Washer
21-391	G-3148	2" Cap Gasket
21-500	O-2126	1 1/2" Piston Seal O-ring
21-502	O-2195	1 1/2" Cap O-ring
21-505	G-5114	Piston O-ring
23-256	G-4421	Rubber Disc
23-671	O-1039	18" Hercules Tank O-ring
25-229	O-2226	2" Tailpiece O-ring
25-311	O-1050	6" Pump Lid O-ring
25-313	O-2058	8" Sidewinder O-ring
25-575	G-4207	Neptune Sand Filter Gasket
25-744	O-1083	15" Atlas DE Filter Tank O-ring
25-745	O-1042	24" Tank O-ring
27-379	G-4283	Hercules Filter Lid Gasket
27-671	O-1039	18" Tank O-ring
27-678	O-1014	Hercules II Tank O-ring
29-113	O-2024	Series 220 Shaft Extension & Crank O-ring
29-225	O-2006	Return Spin Filter O-ring
29-674	O-2195	1 1/2" Tailpiece O-ring
29-869	G-4292	Rubber Washer
30-828-750	K-6008	1 1/2" Valve O-ring/Gasket Kit
30-828-754	K-6009	2" Valve O-ring/Gasket Kit
31-157	O-2009	300 Series Swivel O-ring
31-158	O-2262	Volute O-ring
31-159	O-2026	Volute O-ring
31-160	O-2138	100 Series Adapter O-ring
31-161	O-2187	200 Series MK2 Volute O-ring
31-162	O-2143	Booster Pump Volute O-ring
31-256	O-2041	O-ring
31-276	G-3256	1/2-2 HP Volute Gasket
31-346	O-2099	4" Pump Lid O-ring
31-418	O-2306	Renegade 725 O-ring
31-420	O-2306	Renegade Volute O-ring
31-486	O-2228	5" Cover O-ring
31-713	O-1016	7" Lid O-ring
31-812	MS-201	Pump Seal
31-813	MS-1000	Pump Seal
31-814	E-6503	Pump/Motor Shaft Extension
32-248	G-3240	Bronze Strainer to Volute Gasket
33-229	O-2189	O-ring Set For Pump (O-2189 & O-2226 Make Set)
33-248	G-3240	Pot to Volute Gasket
33-487	O-2167	Clear Lid O-ring
33-489	O-2167	6" Cover O-ring
35-162	O-2209	Volute O-ring
35-271	G-3220	Bracket to Volute Gasket
39-271	G-3220	Bronze Pump Gasket
39-441	O-2032	8" Trap Lid O-ring

FITS OEM#	SSC#	DESCRIPTION
P-136P	O-2060	New Style Clear Lid O-ring
P-13-6P	O-2249	Clear Lid O-ring
P-2P	O-2134	2" Piston O-ring
P-7515	O-2126	1 1/2" Backwash Valve O-ring
P-NPL	O-2226	Large Noryl Pump Volute O-ring
P-NPS	O-2189	Small Pump Volute O-ring-Noryl
SG-364	G-4310	Sight Glass Gasket
VB38	G-3275	Volute Gasket
PUREX (PUREXTRITON) (DIVISION OF PENTAIR)		
--	O-2106	CHD O-ring
--	O-2141	CHD Crank O-ring
--	O-2155	CHD 2" O-ring
--	O-2165	N/S Tahitian Adapter O-ring
--	O-2240	Eastside 4" H&L Trap O-ring
--	O-2247	Eastside 6" H&L Trap O-ring
--	G-3114	Eastside Pump Gasket
--	G-3126	Eastside Old Style 6 Hole Pot to Volute Gasket
--	G-3130	Eastside Old Style 8 Hole Pot to Volute Gasket
--	G-3139	Eastside Old Style Volute Gasket
--	G-3147	Eastside Seal Well Gasket
--	G-3248	Eastside 2 Hole Pot to Volute Gasket
--	F-8109	Tahitian Sand Filter O-ring Kit
--	F-8307	CF-25 & CF-50 Cartridge Filter O-ring Kit
--	R-6122	L & AA Series Pump Repair Kit
--	R-6123	C Series Pump Repair Kit
--	R-6124	Aquatron Pump Repair Kit
--	R-6125	Whisperflo Pump Repair Kit
70152	G-4268	Index Plate BH Valve Gasket
70155	K-6006	Piston O-ring Kit
70156	O-2082	O-ring
70169	G-4271	Bulkhead Gasket
70211	G-5006	OOB7013 Gasket V-Band Lid
70212	O-2188	OOB7014 Valve Piston O-ring
70213	G-5058	New Style Bulkhead Union Ring
70213	O-2040	Old Style Bulkhead Union O-ring-00B7027
70238	O-2106	OOB7001 Bulkhead O-ring
70247	O-1210	Control Plate Gasket/O-ring
70345	O-2155	O-ring
70393	6203	#203 AH Bearing
70394	6304	#304 AH Bearing
70935	G-4149	Cover Gasket
70940	G-3255	Pot to Volute L Series Pump Gasket
70941	G-3247	Uniseal & L Series Bracket to Volute Pump Gasket
70942	G-4266	Tropic Inlet/Outlet Gasket For All Models
70943	G-4123	C Series Pot to Volute Gasket
70943	G-4247	Flange Gasket
70944	G-4430	Valve Gasket
70945	G-5126	Light Lens Gasket
70947	G-4164	Sunlite Niche Face Ring Gasket
70951	G-4329	Tube Seal Gasket
70952	G-3175	Air Relief Fitting Gasket
71416	O-2138	Eastside Seal Plate O-ring
71417	O-2209	AT Series Pump B/V O-ring
71418	O-2079	JT Adapter O-ring
71419	O-2208	Whisperflow Lock Screw O-ring
71420	O-2086	O-ring for Soltron
71421	O-2247	PJ-18 Pump Lid O-ring
71422	O-2041	Aquatron Lid O-ring
71423	O-2249	Flange O-ring
71423	O-2604	Blue Teflon Coated Flange O-ring
71424	O-2189	Cap O-ring
71426	O-2165	Collar & Rotor O-ring
71427	O-2209	Aquatron Pump B/V O-ring
71428	O-2220	Tahitian Cap & Rotor Shaft O-ring

OEM PART# CROSS REFERENCE

FITS OEM#	SSC#	DESCRIPTION
71430	O-2144	O-ring
71431	O-2231	800 Series Manifold O-ring
71432	O-2155	2" Valve Cap O-ring
71433	O-1067	C-18 Cover O-ring
71434	O-2221	Noryl Rotor Shaft O-ring
71435	O-2124	Noryl Rotor Shaft O-ring
71435	O-2124	O-ring for 2-113
71436	O-2090	Sel. Valve Shaft O-ring
71437	O-1039	CF-100 Tank O-ring
71439	O-1029	SM 4000 Tank O-ring
71440	O-2189	Coupling O-ring
71441	O-1063	CF-25, 50 & 700 Tank O-ring
71442	O-1073	2000 Series Tank O-ring
71442R	O-1093	Tank O-ring-Red Line CF-100, SM-1000, 2000
71443	O-1074	800 Series Tank O-ring
71444	O-2103	Whisperflo Diffuser O-ring
71445	O-2216	Whisperflo Seal Plate O-ring
71446	G-3157	Old Style Vinyl Niche Gasket
71447	O-2067	PA Series Pump O-ring
71448	O-2034	Valve Body O-ring
71449	O-2223	Tahitian Filter Shaft O-ring
71722	G-5117	Piston O-ring
71723	MS-372	Pump Seal
71725	MS-360	Pump Seal
71728	MS-201	Pump Seal
71733	MS-100	Pump Seal
71733	MS-200	Pump Seal
71733	MS-501	Pump Seal
71734	MS-1000	Pump Seal
72187	G-4285	Eastside Pump Water Slinger Gasket
72551	O-2175	Mixing Valve Lifflock O-ring
72552	O-2220	Shaft Lifflock O-ring
72553	O-2030	Ortega 1 1/2" Cover Seal
72554	O-2044	Ortega 2" Cover Seal O-ring
72555	O-2024	Ortega Valve Stem O-ring
72557	O-2243	Ortega Valve Equalizer O-ring
72559	O-2040	1 1/2" Ortega Valve Cap O-ring
72560	O-2270	2" Ortega Valve Cap O-ring
72999	G-3220	Guardex Washer-Fiber
72999	G-4428	Guardex Washer-Rubber
73270	O-1154	Filter Tank O-ring
74015	G-4455	Flow Valve Gasket
74021	O-2234	CFM Manifold O-ring
74565	G-4646	New Style Whisperflo Seal Plate Gasket/O-ring (After 1994)
74629	G-4633	Drain Gasket
75114	G-4624	Ortega Rubber Washer
75713	O-2208	Whisperflo O-ring
B-94	O-2282	Regular Lid O-ring
B-94	G-5008	Square Cut Ring-Aqua Brominator CB8-4 to CB8-45
CB8-45	G-5008	Hydrotech Square Cut Ring
P-10630	G-3253	BT Series Backwash Valve Pump Gasket
P-10675	G-3243	VF30 Gasket
P-11125	G-4245	Tropic Inlet/Outlet Heater Gasket
P-11200	G-4129	Flo Valve Gasket
P-11250	G-4416	Valve Gasket
P-24275	O-1063	Filter Lid O-ring
P-24305	O-2106	Center Tube O-ring
P-26136	O-2243	Ortega Equalizer O-ring
P-28050	MS-1000	Pump Seal
P-29300	MS-201	Pump Seal

FITS OEM# SSC# DESCRIPTION

RAINBOW LIFE GUARD (DIV. OF PENTAIR)

--	F-8325	3 & 4 OZ. Cartridge Filter O-ring Kit
17-2009	O-2114	Cartridge Filter Lid O-ring
17-2009	O-2522	Chlorinator Lid Viton O-ring
17-2015	G-4279	Lifeguard Cartridge Filter Gasket
17-2033	G-4327	Tube Fitting Gasket
17-2221	O-2135	RTL Filter Air Vent Valve O-ring
17-2222	G-4337	Cartridge Gasket
17-2223	O-2095	25 Sq. Ft. Filter Lid O-ring
17-2224	O-2135	O-ring
17-2240	O-2528	Chlorinator Lid O-ring for HC3340-Viton
17-2263	G-4393	1/2" Saddle Gasket
17-2319	O-2112	320 Chlorinator Base O-ring
17-2393	O-2082	DSF Skimmer Access Plug O-ring
17-2451	O-2264	Check Valve O-ring
17-2470	G-3036	DSF Skimmer Rear Gasket
17-2471	G-3002	DSF Skimmer Front Plate Gasket
17-2541	G-3183	Dynamic Lock Gasket
18608	O-2041	Leaf Trap O-ring
18658	G-4621	Leaf Trap Gasket for Cartridge
21-1236	O-2041	180 Leaf Trap Lid O-ring
21-1366	O-2041	In Line Leaf Trap Lid O-ring
33-0017	O-2141	Dynamic Chlorinator O-ring
R37009	O-2326	Concorde Motor Housing O-ring
R37121	O-2324	Concorde Plate O-ring

RAYPAK

--	O-2024	Manual By-Pass O-ring
--	O-2040	U-G #H O-ring
--	O-2040	Solar Valve Body Union O-ring
--	O-2102	Control Well O-ring
006724F	K-6021	O-ring Kit
06713F	O-2393	O-ring
800004	G-3246	1 1/2" Unitherm Governor Gasket
800007	G-3265	2" Unitherm Gasket
800014B	G-4314	Gemini Tube Seal Gasket
800031	O-2124	Bypass Manual O-ring
800075	G-4420	Heater Gasket
800080B	G-5036	2" Flange Gasket
800086	G-4346	155B Versa Gasket
800086B	G-5002	1" Square Cut O-ring
800104	O-2134	Raytemp O-ring For Piston Valve
800164	G-4246	Element Gasket
800187	G-4432	Heater Gasket
800204	G-4408	Bypass Gasket
800276	G-4357	WHG 55A Gasket

REGAL

G-202	G-4312	Chlorinator Gasket (For Kit Order 2)
G-203	G-4205	Chlorinator O-ring
G-204	G-4232	Chlorinator Gasket
S-301	O-2503	Chlorinator Viton O-ring
S-302	O-2507	Chlorinator Viton O-ring
S-401	O-2520	Chlorinator Viton O-ring
S-402	O-2506	Chlorinator Viton O-ring
S-403	O-2502	Chlorinator Viton O-ring
S-404	O-2124	Chlorinator O-ring
S-405	O-2259	Chlorinator O-ring
S-406	O-2129	Chlorinator O-ring
S-407	O-2131	Chlorinator O-ring
S-408	O-2005	Chlorinator O-ring
S-409	O-2226	Chlorinator O-ring
S-410	O-2124	Chlorinator O-ring
S-411	O-2505	Chlorinator Viton O-ring
S-412	O-2516	Chlorinator Viton O-ring
S-413	O-2051	Chlorinator O-ring

OEM PART# CROSS REFERENCE

FITS OEM#	SSC#	DESCRIPTION
RICHARDSON (SEE ALSO E-Z CHLOR)		
--	O-1119	18" Sand Filter O-ring
--	O-1138	22" Tank O-ring
--	O-1139	Cartridge O-ring
--	O-2134	Sand Filter Valve Adapter O-ring
--	G-4360	Thick Sand Filter Gasket
--	G-4361	Thin Sand Filter Gasket
4546-001	O-1153	Cartridge O-ring
5099-125	O-1152	18" Tank O-ring
5099-135	O-1076	22" Filter Tank O-ring
5099-149	O-2278	Sand Lid O-ring
5099-504	G-4395	Air Bleeder Gasket
5099-518	G-5064	Sand Gasket
5099-525	O-2152	1/2" Valve Adapter O-ring
5099-529	O-2002	2" Sand Valve Adapter O-ring
5535-101	O-2058	Sand Filter O-ring
R-44	O-1119	O-ring
SAURERMAN		
--	O-1020	Small Tank O-ring
--	O-1026	Large Tank O-ring
--	O-2006	Manifold O-ring
--	O-2009	1 1/2" Tube O-ring
--	O-2106	2" Tube O-ring
--	O-2141	2" Tube O-ring
--	O-2231	Backwash Valve Valve O-ring
SEARS (HOMART)		
--	G-3118	Sprinkler Gasket
259-043	MS-162	Pump Seal
42G2377W	MS-100	Pump Seal
W6476	MS-162	Pump Seal
SEASON MASTER		
SMS-1023G	G-4290	Skimmer Wall Fitting Gasket (For Kit Order 2)
SMS-1094G	G-4001	Face Plate Gasket (for Kit Order 2)
SLINGERS (WATER SLINGERS)		
--	G-4253	Water Slinger-1 1/4" OD x 11/32" ID
--	G-4256	Water Slinger-1 3/4" OD x 13/16" ID
--	G-4263	Water Slinger-1 5/32" OD x 7/16" ID
--	G-4285	Water Slinger-1 1/4" OD x 5/8" ID
--	G-4601	Water Slinger-1 1/2" OD x 1/2" ID
--	G-4629	Water Slinger-1 3/8" OD x 1/2"ID-For 48 Frame Above Ground Pumps
SONFARREL (SEE MARTEC)		
SOUTH PACIFIC		
--	O-1022	Old Style White Lid O-ring
--	O-1027	New Style Brown Lid O-ring
--	O-2107	Old Style Brown Lid O-ring
SOUTH SEAS		
--	G-3204	Outlet Heater Gasket
--	G-4224	Small Rubber Gasket
--	G-4242	Bypass Gasket
--	G-4255	Large Rubber Gasket
--	G-4414	Inlet Bypass Gasket
--	G-5043	Tube Gasket
VB11	G-4011	Inlet Heater Gasket
VB12	G-4023	Outlet Heater Gasket

FITS OEM#	SSC#	DESCRIPTION
SPECK		
2020341210	O-2059	O-ring
2301001013	G-4139	Badujet/Stream Gasket
2301002025	G-4342	Badujet/Stream Gasket
2302002060	G-4140	Badujet IT Gasket
2302002062	O-2141	Badujet O-ring
2303002002	G-4138	Jet Gasket
2920141210	O-2071	Casing O-ring, 410 Lid O-ring, Etc.
2920141220	O-2091	410 Casing O-ring
2920141230	O-2220	Filter Plug O-ring
2920141240	O-2141	Model 90 Drain Plug O-ring
2920141250	O-2188	Casing O-ring Model 420
2920241210	O-2308	O-ring
2920241220	O-2152	Model 440 Union O-ring
2920341220	O-2304	Model 400 2 Bolt O-ring
2920341225	O-2305	Model 400 4 Bolt O-ring
2920741210	O-2249	Model 423 Lid O-ring
2920741270	O-2010	Model 423 Tank O-ring
2920841210	O-2304	433T Lid O-ring
2920941210	O-2293	Lid O-ring
2921141210	O-2304	90 Lid O-ring
2921141220	O-2307	Model 90 Casing O-ring
2921641210	O-2345	E91 Pump Lid O-ring
2923141000	G-4448	Model 21-80 Gasket
2923441200	O-2221	Model 21-80 O-ring
2923541220	O-2024	Pump Housing O-ring
2926999990	G-4136	Sand/DE Filter Rim Gasket
2991300001	O-2091	913 Casing O-ring
2991300002	O-2056	Badustar 913 Diff. O-ring
2991300003	O-1083	Badustar 913 Lid O-ring
2991300004	O-1140	Badustar 913 Cartridge O-ring
2991300005	O-2200	Badustar 913 Cartridge O-ring
2991500001	O-2381	Bearing O-ring
412.9	O-2141	Model 420 Drain Plug O-ring
60603-200	MS-200	Pump Seal for E-91
SPIN RITE		
--	O-2006	Collection Tube O-ring
--	O-2024	Crank O-ring
STA RITE		
--	O-2002	PMKGFV 15-20-25-33 Collection O-ring
--	O-2010	Unitrol Valve Piston O-ring
--	O-2025	PDC Bottom O-ring
--	O-2041	Delrin and Sand O-ring
--	O-2041	Sand Filter Cover O-ring
--	O-2082	31B0035 Index Plate O-ring
--	O-2082	Index Plate Small O-ring
--	O-2106	Dep. 83 Valve Adapter O-ring
--	O-2128	Delrin Hi Prime H&L O-ring
--	O-2135	MK23 Crank O-ring
--	O-2150	Vertifilter Manifold O-ring
--	O-2165	Float Valve O-ring
--	O-2188	Valve Piston O-ring
--	O-2211	Dial Valve O-ring
--	O-2240	4" Old Style Pump Lid O-ring
--	O-2247	Old Style 6" Lid O-ring
--	O-2252	XL-VII Bracket to Volute O-ring
--	O-2280	Plastic Slide Valve Cap O-ring
--	O-2280	Index Plate Large O-ring
--	O-2282	HRV 24 O-ring
--	O-2405	Spin Filter Tube Quad Ring
--	O-2411	Upright Spin Crank Quad Ring
--	G-3115	VB35-1 Submersible Pump Gasket
--	G-4444	Aqua Flyte H&L Gasket
--	G-5006	Ring For HRP36 Filter
--	G-5058	Ring For HRP36 Bulkhead Connection
--	F-8116	High Rate 36" Sand Filter O-ring Kit
--	F-8117	Pantera, T-HRP Sand Filter O-ring Kit

OEM PART# CROSS REFERENCE

FITS			FITS		
OEM#	SSC#	DESCRIPTION	OEM#	SSC#	DESCRIPTION
--	F-8118	Separation Tank O-ring Kit	24700-74	O-1033	Tank O-ring
--	F-8205	DEP36, HRP20, HRP20-01B Verticle DE O-ring Kit	24750-0006	O-1151	HRPB O-ring
--	F-8206	DEP51, HRP24, HRP24-01B Verticle DE O-ring Kit	24750-05	O-1106	20" DEP-36 Fiberglass Filter O-ring
--	F-8207	DEP83, HRP30, HRP30-01B Verticle DE O-ring Kit	24751-0006	O-1155	HRPB O-ring
--	F-8208	DES25, HRS16-01 Vert. Sand & DE O-ring Kit	24751-05	O-1009	24" DEP-51 Fiberglass Filter O-ring
--	F-8209	DES36, HRS20-01 Vert. Sand & DE O-ring Kit	24752-0006	O-1156	HRPB O-ring
--	F-8210	DES51, DES60 HRS24-01 Sand & DE O-ring Kit	24752-05	O-1046	30" DEP-83 Fiberglass Filter O-ring
--	F-8318	35, 50 S/F Posi-Flo Cartridge Filter O-ring Kit	24753-05	O-1007	DEP-25 216, 108, 72 Cartridge O-ring-Fits 16"
--	F-8319	70, 100 S/F Posi-Flo II Cart. Filter O-ring Kit	24850-0008	O-1164	21" Multimedia Filter O-ring
--	F-8320	135 S/F Posi-Flo Early & Late Cart. O-ring Kit	25575-0114	O-2135	Drive Shaft O-ring
--	F-8321	TXC25, 25B, 50, 50B, 75, 100 Cart, O-ring Kit	27001-0060S	O-1157	System 3 Cord O-ring (Pre-3/97)
--	R-6109	Duraglass/Maxiglass Pump Repair Kit	27001-0061S	O-1162	Filter O-ring
--	R-6110	Cast Iron Pumps Repair Kit	2PLL	G-4274	Light Lens Gasket
--	R-6133	Maxi-Glas II & Dura-Glas II Pump Repair Kit	31935-0001	O-2046	Posi Flo II Lid O-ring
--	R-6134	PE, PEA, P2R, P2RA, AJ Pump Repair Kit	33450-8041	G-3411	Commercial Volute Suction Gasket
--	R-6135	1 1/2" & 2" Universal Slide Valve Repair Kit	33450-8042	G-3410	Commercial Volute Discharge Gasket
--	R-6136	CF, CFA, CF6 Pump Repair Kit	33455-1047	G-5072	Impeller Screw Gasket
--	R-6144	Dynaglass & J Pump Repair Kit	33455-8043	G-3408	Commercial Impeller to Shaft Washer
--	R-6150	Flo Tech, Aquatools, Dynaglass Pump Repair Kit	33455-8044	G-3409	Commercial Impeller to Shaft Sleeve Gasket
--	O-2228	5" Clear Lid O-ring	35505-0114	O-2135	Crank Shaft O-ring
--	G-3119	D Series Pump Gasket	35505-0114	O-2406	Crank Shaft Quad Ring
--	K-6006	31B0024 O-ring Repair Kit	35505-0198	O-2175	3 Port Actuator O-ring
--	O-2172	XLVII H & L Pot O-ring	35505-0239	O-2254	Skimmer Tube O-ring
--	O-2082	31B0035 Index Plate O-ring	35505-0314	O-2188	Q30 MK O-ring
--	R-6175	Dura Glas/Maxi Glas & P2R/P2RA Pumps-After 1998	35505-0421	O-1163	Trap Lid O-ring
05057-0667	G-4148	Light Niche Gasket	35505-0422	O-1082	Seal Plate Housing O-ring
05057-118	G-5124	Light Lens Gasket	35505-1007	O-2019	Hydro Valet Face Plate Inlet O-ring
05103-0101	G-4614	Niche Gasket	35505-1009	O-2222	Hydro-Valet Face Plate Inlet O-ring
05161-0006	G-4159	Niche ABS Liner Gasket	35505-1116	O-2082	Piston Assembly O-ring
07017-0079	G-3401	Drain Gasket	35505-1121	O-2096	Dial Valve O-ring
0956-0150	G-4050	Standard Skimmer Gasket	35505-1152	O-2090	Dial Valve Shaft O-ring
0956-0152	G-4060	Above Ground Skimmer Wide Mouth Gasket	35505-1157	O-2102	Knob O-ring
14962-21	G-5012	Caprice Valve 1 1/2" Square Ring	35505-1175	O-2009	Valve Connector O-ring
14962-35	O-2211	Large O-ring For Kit	35505-1223	O-2239	2" Valve Stem O-ring
14962-35	O-2255	Small O-ring For Kit	35505-1228	O-2255	Dial Valve O-ring
14971-0011	G-4619	2" Multiport Valve Sight Glass Gasket	35505-1233	O-2142	Index Plate O-ring
14971SM20E12	G-5120	Spider Gasket-5 Spoke	35505-1236	O-2231	Sil. Seal & Capri Return O-ring
16503-07	O-2088	Body O-ring	35505-1238	O-2189	FCP Cartridge Drain Plug O-ring
16800-11	G-3228	Pump Gasket	35505-1245	O-2111	Turbo Clean Head O-ring
16800-29	G-3228	XLVI Old Style Gasket	35505-1246	O-2280	Turbo Clean Head O-ring
16800-29	E-6506	Pump/Motor Shaft Extension	35505-1263	O-2042	1 1/2" Piston O-ring-Brass Pucks-Old Style
16920-12	O-2095	XL-VII Pump O-ring	35505-1263	O-2138	XLII Pump Seal Plate O-ring
17140-0026	G-4641	Flo Tec Pump Body Gasket	35505-1266	O-2088	XLIII Pump Seal Plate O-ring
17150-0007	G-4615	4" Trap Gasket	35505-1272	O-2041	O-ring
17304-0100	MS-200	Pump Seal for Dura Glas/Maxi Glas Pumps-After 1998	35505-1273	O-2041	Float Valve O-ring
23382-13	O-1043	Model X Filter O-ring	35505-1275	O-2209	Cover O-ring For M/V WC112-147
23383-13	O-1117	SilverSeal, Capri Tank O-ring	35505-1281	O-2022	Skimmer O-ring
23383-15	O-1038	X Model Tank O-ring	35505-1313	O-2134	2" Piston O-ring
23568-15	O-1048	Separation Tank O-ring	35505-1317	O-2100	Fill Cap & MF23 Tube O-ring
24240-04	O-1004	Cobra & Falcon Body O-ring	35505-1318	O-2010	Piston Plastic Slide Valve-2"
24700-68	O-1133	16" DES-25, HRS-16 Tank O-ring	35505-1323	O-2120	Roto-trol Valve O-ring
24700-69	O-1084	Tank O-ring	35505-1332	O-2114	O-ring
24700-71	O-1118	Tank O-ring	35505-1338	O-2121	XLVI Pump Lid O-ring
24700-72	O-1015	20" DES-36, HRS-20 Tank O-ring	35505-1344	O-2228	O-ring
24700-73	O-1002	24" DES-51 & 60 Tank O-ring	35505-1365	O-1010	O-ring
			35505-1401	O-2004	Index Plate & Piston O-ring-Plastic Pucks
			35505-1401	O-2042	Index Plate & Piston O-ring-Brass Pucks
			35505-1402	O-2266	O-ring
			35505-1408	O-2025	XL-VII Pump Volute O-ring
			35505-1409	O-2041	Skimmer Lid O-ring
			35505-1412	O-2297	Lid O-ring Multiport Valve Side Mount O-ring
			35505-1421	O-2297	Lid O-ring For 2" Side Mount Valve
			35505-1423	O-2092	System 3 Sand Adapter O-ring
			35505-1424	O-2002	System 3 O-ring
			35505-1425	O-2114	System 3 O-ring
			35505-1426	O-2386	Impeller Screw O-ring
			35505-1428	O-2040	Elbow Assembly O-ring

OEM PART# CROSS REFERENCE

FITS			FITS		
OEM#	SSC#	DESCRIPTION	OEM#	SSC#	DESCRIPTION
35505-1429	O-2231	Elbow Assembly O-ring	S04757	G-3412	Commercial Volute to Bracket Gasket
35505-1437	O-2086	ABG Pump Trap Lid O-ring	U109-006A	MS-162	Pump Seal
35505-1438	O-2266	ABG Pump Seal Plate O-ring	U109-047	MS-201	Pump Seal
35505-7430	O-2007	O-ring	U109-068	MS-163	Pump Seal
35505-7432S	O-2094	Pool Heater Manifold O-ring	U109-093SS	MS-100	Pump Seal
35515-0114	O-2406	Crankshaft Quad Ring	U109-136SS	MS-1000	Pump Seal
35515-0314	O-2188	Q30 MK Adapter O-ring	U109-170	MS-703	Pump Seal
35515-0317	O-2412	Filter Collection Tube O-ring	U109-220	MS-381	Pump Seal
35515-0318	O-2419	Collection Tube Quad Ring	U9-045	O-2099	4" Pump Lid O-ring
35515-0514	O-2419	Collection Tube Quad Ring	U9-046	O-2167	6" Pump Lid O-ring
35515-1296	O-2403	Valve Connector Quad Ring	U9-103	MS-162	Pump Seal
35515-1297	O-2409	CFP Cartridge Filter Valve Connector Quad Ring	U9-105	O-1032	11" Trap Lid O-ring
35575-1114	O-2208	Shaft O-ring-MK37, 47, 57 Series	U9-114	O-2252	Pump O-ring
37400-0027S	MS-851	Pump Seal for Max-E-Glass II, Dura-Glas II	U9-145	O-1039	18" Tank O-ring
37407-0019	MS-201	Pump Seal	U9-147	O-2024	Bronze Cap Valve O-ring
42001-0066S	G-3284	Ignitor Gasket	U9-151	O-2142	1 1/2" Piston O-ring
489031	G-5047	Head Quad Ring	U9-152	O-2134	2" Valve O-ring
77707-0117	O-2261	Pool Heater O-ring (for kit order 6)	U9-154	O-2008	1 1/2" Return Filter O-ring
8490-31	G-5047	Head Quad Ring	U9-156	O-2002	2" Return Hub O-ring
8652-5	G-4012	U-3 Skimmer Face Plate Gasket	U9-160	O-1008	20" Tank O-ring
8653-7	G-4008	Skimmer Gasket	U9-161	O-2218	5" Pump Trap Lid O-ring
AS-201	MS-201	Pump Seal	U9-165	O-1042	24" Tank O-ring
C20-009	G-3162	Pump Gasket	U9-167	O-2252	Pump O-ring
C20-015	G-4436	Pump Gasket	U9-171	O-2107	8" Trap Lid O-ring
C20-019	G-3240	Dura Glass Pump Gasket	U9-174	O-2142	1 1/2" Valve O-ring
C20-021	G-3151	Pump Gasket	U9-175	O-1006	Separation Tank O-ring
C20-031B	G-4412	LT Series Seal Plate Gasket	U9-191	O-1014	Separation Tank O-ring
C20-035	G-3023	Delrin Plastic Volute Gasket	U9-199	O-2231	Diffuser O-ring
C20-046	G-3164	Pump Gasket	U9-200	O-1011	PLBC Tank O-ring
C20-072	G-3249	Thin Pump Gasket	U9-203	O-2159	Sand Filter O-ring
C20-072	G-3256	Thick Pump Gasket	U9-205	O-2165	Sand Filter Riser Tube O-ring
C20-077	G-3261	C & CC Series Pump Gasket	U9-207	O-2128	Cover O-ring
C20-079	G-3226	AJ Series Gasket	U9-211	O-2266	Sand Filter Cover O-ring
C20-086	G-3118	Sears Sprinkler Gasket	U9-221	O-2090	WC-212-7 Valve Cap O-ring
C20-087	G-3123	Well & Irrigation Pump Gasket	U9-226	O-2195	Duraglass Diffuser, Quantum Spa, Cart. O-ring
C20-100	G-3199	CC Gasket	U9-228	O-1082	Dura Glass Pump Clamp O-ring
C20-101	G-3197	CC Seal Gasket	U9-228A	O-2306	P2R Pump Housing O-ring
C20-102	G-3258	ACP Pump Seal Plate Gasket	U9-229	O-2060	Dura Glass Pump Lid O-ring
C20-103	G-3241	Duraglass Pump Gasket-Fiber	U9-239	O-2030	Pump O-ring
C20-103	G-4411	Duraglass Pump Gasket-Rubber (Larger Bolt Holes)	U9-240	O-2044	Pump O-ring
C20-103	G-4441	Duraglass Pump Gasket-Rubber	U9-241	O-2217	Pump O-ring
C20-123	G-4441	Trap Outlet Gasket	U9-243	O-2067	Cover O-ring
C69-002	G-4206	Duraglass Pump Slinger Gasket	U9-244	O-2110	O-ring
C69-002	G-4253	Water Slinger Gasket (Replaces N69-001)	U9-245	O-2009	Plunger Top O-ring
C69-012	G-4256	C Pump Water Slinger Gasket	U9-259	O-1036	Sep. Tank O-ring
CN20-035	G-3259	Pump Gasket	U9-265	O-2271	C Series Shaft O-ring
G20-012	G-3208	Well & Irrigation Pump Gasket	U9-269	O-2189	Cartridge Filter Drain Plug O-ring
J20-009	G-3129	Well & Irrigation Pump Gasket	U9-285	O-2150	Trap Adapter O-ring
J20-011	G-3136	Well & Irrigation Pump Gasket	U9-295	O-2099	Pump Cover O-ring
J20-012	G-3208	Well & Irrigation Pump Gasket	U9-301	O-2047	Posi Flo Top O-ring
J20-016	G-4426	Well & Irrigation Pump Gasket	U9-309	O-2001	Plunger O-ring
L20-40	G-4620	PLBC Small Gasket	U9-357	O-2266	Dura Jet Seal Plate O-ring
L21-001	G-5034	Pump Diffuser Ring	U9-358SS	MS-201	Pump Seal
N20-025	G-3233	Gasket	U9-359	O-2024	Posi Flo II Air Release O-ring
N20-026	G-3236	Pump Gasket	U9-362	O-2111	Valve O-ring-WC212
N20-035	G-3259	Pump Gasket	U9-366	G-3032	U3 Auto Skimmer Gasket
N20-039	G-3229	Pump Gasket	U9-369	O-2094	V/F Tank Flange O-ring
N69-001	G-4253	Water Slinger Gasket (C69-002 Replaces This)	U9-370	O-2259	Lateral O-ring
P-61	MS-100	Pump Seal	U9-371	O-2134	Drain Cap O-ring
P64-057	O-2141	Paraport Valve Seal O-ring	U9-373	O-2305	Dynaglass Seal Plate O-ring
P64-069	G-4205	P/V Sight Glass Gasket	U9-374	O-2002	Diffuser O-ring
PP11-00	R-6110	Cast Iron Pumps Repair Kit-Fits All CK & CRA4	U9-375	O-2247	Maxi Glass II Trap O-ring
PS20-011	G-4406	Top Plate Gasket	U9-376	O-2142	Maxiglas II Shaft O-ring
PS20-018	G-4406	Pump Gasket	U9-389	O-1011	PLBC Tank O-ring
Q4112	O-2406	Large Crank Quad Ring	U9-399	O-2247	Maxi Glass Trap O-ring
Q4327	O-2405	Manifold Quad Ring	VB43	G-3222	Pump Gasket
			WC20-02	G-4204	Filter Gasket
			WC20-03	O-1227	6.5" Sep. Tank Gasket
			WC20-04	G-5024	9.5" Separation Tank Gasket

OEM PART# CROSS REFERENCE

FITS		
OEM#	SSC#	DESCRIPTION
WC20-05	G-4115	Filter Gasket
WC20-11	G-4336	Filter Gasket
WC20-15	G-4239	Sand Filter Gasket
WC20-16	G-4105	Sand Filter Gasket
WC20-24	O-2195	Pump O-ring
WC298-88	K-6007	PVC Valve Repair Parts Kit
WC9-002	G-4387	Sight Glass Gasket
WC9-003	O-1010	Cartridge Filter Tank O-ring
WC9-007	O-2282	Sand Filter O-ring
WC9-011	O-1059	Cartridge Filter O-ring
XL-VII	O-2172	H&L Pot O-ring
STARBRIGHT		
--	O-1028	SEP Tank O-ring
--	O-1037	20" Tank O-ring
--	O-1090	Tank O-ring
--	O-2177	Skim Filter Manifold O-ring
--	O-2406	Crank Quad Ring
SUNDANCE		
6560-043	O-1150	Hi Flo Heater O-ring
6560-044	O-2226	Hi-Flo Heater Union Fitting O-ring
6560-045	G-4044	Hi Flo Heater Box Gasket
6560-046	G-4045	Hi Flo Heater Element Gasket
SUPERFLOW		
--	O-1085	PF-50, SCS
--	O-1087	PF-50, SCS
SWIMLINE		
14118	O-1225	Gasket
SWIMRITE		
--	O-1040	50-57 Verticle Filter O-ring
--	O-2002	Lid O-ring
--	O-2121	H&L Lid O-ring
--	O-2124	Shaft O-ring
--	O-2228	5" Clear Lid O-ring
--	O-2255	Old Style Lower Piston O-ring
14-828-381	G-4320	Block Hose Washer
28-828-021	O-2038	O-ring
28-828-324	G-4419	Bracket Mounting Gasket
28-828-325	G-4251	Washer
28-828-667	O-2115	Return Hub O-ring
28-828-668	O-2029	Ret. End Bell O-ring
28-828-671	O-1039	18" Filter Tank O-ring
28-828-675	O-2024	Spin Crank O-ring
28-828-678	O-2006	Spin Filter Manifold O-ring
28-828-679	O-2115	Return O-ring
28-828-681	O-2264	Marathon Grid O-ring
28-828-686	O-1130	Ventirite Series Tank O-ring
28-828-687	O-1073	18" Ventirite Tank O-ring
28-828-689	O-1132	Marathon Filter O-ring
28-828-745	O-1042	24" Satellite tank O-ring
30-828-670	O-2090	Valve Stem O-ring
30-828-678	O-1014	12" Separation Tank Cartridge Lid O-ring
30-828-750	O-2024	1 1/2" x 1 1/2" Shaft O-ring
30-828-752	O-2126	1 1/2" Piston O-ring
30-828-752	O-2142	Valve Cap O-ring
30-828-753	O-2134	2" Piston O-ring For Autoflow Valve
30-828-756	O-2024	1 1/2" V Crank Pump O-ring
30-828-757	O-2126	1 1/2" Piston O-ring
30-828-758	O-2142	Autoflow Cap O-ring
30-828-759	O-2134	2" Piston O-ring
30-828-911	G-4204	Sight Glass Gasket
36-828-114	G-4320	Heater Gasket
36-828-122	G-4329	Tube Heater Gasket
36-828-136	G-4019	Mixing Box Heater Gasket

FITS		
OEM#	SSC#	DESCRIPTION
36-828-146	G-4019	Mixing Box Cover Gasket
36-828-266	G-3206	Pool Control Gasket
36-828-280	G-4275	Washer
36-828-453	G-4208	Washer
38-828-680	O-1063	10" Separation Tank O-ring
38-828-752	O-2133	Cap O-ring
60-828-274	G-3275	P/V Pump Gasket
60-828-276	G-3256	Backwash Valve Pump Gasket
60-828-486	O-2028	5" Clear Lid Gasket
60-828-487	O-2054	7" Clear Lid Gasket
60-828-713	O-1016	7" Stainless Steel Pump Lid O-ring-24.5" C/L
60-828-713	O-1035	7" Stainless Steel Pump Lid O-ring-21.25" C/L
60-828-715	O-2218	5" Pump Lid O-ring
60-828-813	MS-1000	Pump Seal
64-828-946	O-1091	10" Series II Gasket
70-828-827	O-1018	Large O-ring
70-828-828	O-2041	Small O-ring
SYLVAN		
59200236	G-3031	Old Style Vinyl Skimmer Gasket
59201200	G-4363	Throttling Plug Gasket
TANK O-RINGS (GENERIC)		
--	O-1115	13" Tank O-ring
--	O-1066	14" Tank O-ring
--	O-1102	15" Tank O-ring
--	O-1041	16" Tank O-ring
--	O-1114	17" Tank O-ring
--	O-1119	18" Tank O-ring
--	O-1110	19" Tank O-ring
--	O-1106	20" Tank O-ring
--	O-1042	24" Tank O-ring
TAYLOR		
--	G-4423	Aqualite PL-89 1603 Gasket
TELEDYNE LAARS (SEE LAARS)		
TESCO		
--	O-2111	M/A Feeder Cap O-ring
F-35	O-2110	Pure Water Feeder Lid O-ring
H-301	O-2011	Widget Lower Case O-ring
H-301	O-2023	Widget Upper Case O-ring
ULTRA JET (SEE VICO)		
UNIVERSAL		
--	O-1039	Filter Tank O-ring
--	O-1095	Universal Skid Pack Filter Tank O-ring
--	O-1225	Lens Gasket
--	O-2024	Stem & Crank O-ring
--	O-2126	Valve Piston O-ring
--	O-1216	Lens Gasket
--	R-6115	5 Spoke Multiport Rebuild Kit-SP-710/712 After1976
--	R-6116	6 Spoke Multiport Rebuild Kit SP710/711 1969-75

OEM PART# CROSS REFERENCE

FITS OEM#	SSC#	DESCRIPTION
VICO (ULTRA JET)		
PPBFV/OR	O-2209	Big Foot Pump O-ring
PPSFSEAL	MS-201	Pump Seal
PPSFV/OR	O-2212	Super Flo Pump O-ring
PPUFVOR	O-2026	Ultrajet O-ring
PPULPLUGOR	O-2024	Ultrajet Pump Plug O-ring
PPWWVO/R	O-2005	Volute O-ring
UPULO/R2	O-2195	Ultra Flow 2" Union O-ring
VITA		
--	O-2086	Heater Housing O-ring
WALLACE & TIERNAN		
24161	O-2503	Chlorinator Viton O-ring
25900	O-2521	Chlorinator Viton O-ring
26234	O-2506	Chlorinator Viton O-ring
26345	O-2519	Chlorinator Viton O-ring
26482	O-2502	Chlorinator Viton O-ring
26784	O-2611	Chlorinator Viton O-ring
26822	O-2515	Chlorinator Viton O-ring
27409	O-2124	Chlorinator O-ring
27593	G-5051	Chlorinator Gasket
27594	G-5050	Chlorinator Gasket
30066	O-2512	Chlorinator Viton O-ring
30343	O-2507	Chlorinator Viton O-ring
31702	O-2508	Chlorinator Viton O-ring
31882	O-2510	Chlorinator Viton O-ring
33051	O-2520	Chlorinator Viton O-ring
34497	O-2110	Chlorinator O-ring (Not Viton)
34497	O-2520	Chlorinator Viton O-ring
37661	G-4225	Chlorinator Gasket
38437	O-2609	Chlorinator Viton O-ring
39648	O-2517	Chlorinator Viton O-ring
40040	O-2608	Chlorinator Viton O-ring
40336	G-4417	Chlorinator Gasket
41106	O-2521	Chlorinator Viton O-ring
44045	O-2607	Chlorinator Viton O-ring
44119	O-2520	Chlorinator Viton O-ring
44121	O-2210	Chlorinator O-ring
44122	G-4226	Chlorinator Gasket
45336	O-2616	Chlorinator Viton O-ring
46129	O-2256	Chlorinator O-ring
5745	O-2607	Chlorinator Viton O-ring
WATERCO		
621457	O-2264	Gray Valve Shaft O-ring
621462	O-2242	Gray Valve Sight Glass O-ring
63151	O-2167	Supatuf Pump H/L Pot O-ring
634016	MS-601	Pump Seal
6340241	O-2002	Supatuf Pump Union O-ring
635028	O-2214	Supatuf Pump Body O-ring
WATERMATIC		
1-020	G-4451	Rain Cover Gasket
1-110	G-4389	Hopper Lid Gasket
1-190	G-4602	Collar Gasket
1-370	G-4456	Diverter Bracket Gasket
WATERWAY		
--	G-3187	Large (Outside) Gasket For Jet on Medallion Pool
--	G-3188	Small (Inside) Gasket For Jet on Medallion Pool
--	O-2049	Quad Flo Jet O-ring
--	R-6155	48 Fram Pump Repair Kit
--	R-6156	75-125-200 Cyclone Pump Repair Kit
--	F-8326	Top Load Cartridge Filter O-ring Kit
--	O-2377	Housing O-ring for Diverter Gate Valve

FITS OEM#	SSC#	DESCRIPTION
--	O-2115	Return Fitting O-ring, Fitting Coupling O-ring
319-3100B	MS-1000	Pump Seal
568-0360	O-2095	Top Load Filter Lid O-ring
711-1290	G-4349	Bath Jet Gasket
711-1750	G-4364	Polyjet Standard Gasket
711-1760	G-4355	Bath Jet Gasket
711-1920	G-4609	Clearwater Sand Top Gasket
711-1930	G-4639	75-125-200 Filter Drain Cap Gasket
711-4000	G-4358	1 1/2" Union Gasket
711-4010	G-4359	2" Heater Tailpiece Gasket
711-4020	G-4627	2"-2 1/2" Union Gasket
711-4030	G-4644	2" Heater Tailpiece Gasket
711-4031	G-4642	Heater Tailpiece Gasket
711-4050	G-4643	1 1/2" Heater Tailpiece Gasket
711-4100	G-4053	Wide Mouth Gasket
711-4500	G-4356	Power Jet Gasket
711-4750	G-4354	Polyjet Gasket
711-5000	G-4347	Filter Niche Gasket
711-6020	G-4244	2 1/2" Heater Union Gasket
711-7000	G-4390	Spa Jet Body Gasket
711-9870	G-4376	Ozone/Cluster Jet Gasket
715-1001	O-2133	Air Relief O-ring
805-0014	O-2082	Hi-Flo Pump Drain Plug O-ring
805-0111	O-2024	Center Discharge Pump O-ring
805-0114	O-2133	Top Load Filter Air Bleeder O-ring
805-01205D	O-2053	Top Load Filter O-ring
805-0123	O-2263	Tailpiece Union O-ring
805-0132	O-2009	Polyjet O-ring
805-0140	O-2038	Power Jet O-ring
805-0145	O-2159	2" Heater Tailpiece O-ring
805-0145	O-2215	2" Union Connector O-ring
805-0224	O-2115	Heater Tailpiece 1 1/2" O-ring
805-0226	O-2195	1 1/2" Union Tailpiece O-ring
805-0226	O-2195	Union O-ring
805-0229	O-2226	2" Heater Tailpiece O-ring
805-0232	O-2280	2 1/2" Union O-ring
805-0252	O-2025	Bath Pump Volute O-ring
805-0254	O-2211	Top Mount Valve Lid O-ring
805-0256	O-2041	Bath Pump Volute O-ring
805-0261	O-2374	Executive 56 Pump Volute O-ring
805-0360	O-2095	Top Load Filter Lid O-ring
805-0383	O-2388	Clearwater DE, Cartridge Top O-ring
805-0436	O-2060	6" Trap Lid O-ring
805-237V	O-2525	Clearwater Feeder Viton Lid O-ring
806-0003	G-4632	Clearwater Feeder Gasket
806-1040	G-3029	Skim Filter Gasket
806-1070	G-3026	Square Skimfilter Gasket
811-1001AB	MS-1000	Pump Seal
WET INSTITUTE		
--	O-1039	Tank O-ring
--	O-2026	Seal Plate O-ring
--	O-2054	Pump Lid O-ring
32-050-715	O-1061	18" Tank O-ring for DE Filter
34-050-303	O-2247	Pump O-ring
34-050-309	G-3207	Trap to Volute Gasket
34-050-311	MS-1000	Pump Seal
34-050-312	O-2026	Bracket O-ring
WMC		
62100	O-2266	Hydron Sand Filter Neck O-ring
62133	O-2242	Hydro Sand Filter Sight Glass O-ring
621457	O-2264	Hydron Sand Filter Axle O-ring
621462	O-2242	Hydro Sand Filter Sight Glass O-ring
AT-1600-S	O-1226	Strainer Cover Gasket-AT
JS-1505R	O-2195	Union O-ring
JS-1571	O-2309	JS Pump Knob O-ring
JS-1701	O-2041	Pump Housing O-ring-Center Discharge

OEM PART# CROSS REFERENCE

FITS OEM#	SSC#	DESCRIPTION
JS-1702	MS-200	Pump Seal
JS-1903	O-2095	Strainer Cover O-ring
JS-1904	O-2020	JS Pump Strainer O-ring
JS-3701	O-2025	JS Pump Housing O-ring-Side Discharge
SS-1600-R	O-2618	Diffuser Gasket-AT
SS-1600-T	O-1209	Housing Gasket-AT
SS-1600-Z-2	MS-201	Pump Seal

LAMINATED O-RING SIZING GUIDE

Use this guide to identify any loose O-rings you have lying around. The guide is laminated for protection and all O-rings are shown life size with the SSC number clearly marked.

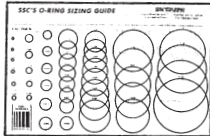

ORG-1
LAMINATED O-RING
SIZING GUIDE
8 Pages

SMALL SIZED O-RING BOX

This kit contains the 24 most popular small sized O-rings for the Pool & Spa industry (2 3/4" OD and less). Each O-ring is identified with the SSC part number. Reference your SSC catalog to see the multiple listings for each O-ring.

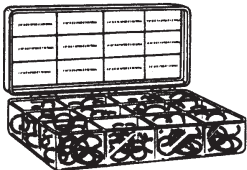

PACKED IN A SHATTER PROOF
PLASTIC BOX WITH 24 COMPARTMENTS

O-9000
SMALL SIZED O-RING BOX
24 different sizes. 10 of each
size O-ring for a total of 240
O-rings in this kit..

O-RING PULLER TOOL

Save those fingers! This inexpensive tool makes O-ring removal fast and easy.



O-10950
O-RING PICK

O-RING CORD

Priced by the foot, O-ring cord is handy to have in case you have to make emergency O-rings in the field.



SSC#	DIAMETER	SSC#	DIAMETER
OC-7000	1/16"	OC-7006	5/16"
OC-7000A	3/32"	OC-7008	3/8"
OC-7001	1/8"	OC-7010	7/16"
OC-7001A	5/32"	OC-7012	1/2"
OC-7002	3/16"	OC-7014	.535"
OC-7004	1/4"	OC-7016	9/16"
OC-7005	9/32"		

A Picture is Worth a Thousand Words...

Our Gasket Picture Guide (pgs. 60-70) shows all of the gaskets we offer in SSC# order. Gasket dimensions are also included for proper identification.

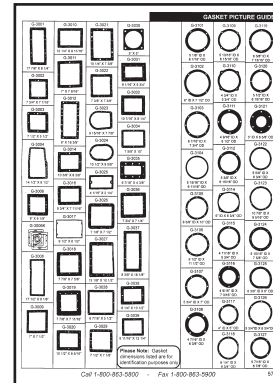

Use SSC's Website to Find Your Replacement Parts and Order Online!

- Place orders online using our shopping cart feature.
- Find more than 2700 different listings of gaskets, O-rings and seals using our multi-functional "Part Search" engine. Part listings are also accompanied by a picture for your reference.
- Take advantage of our unique "View Past Orders" section to look at previous orders you've placed. You can then order from this list.
- This Website also enables you to save the current order you are working on by using our "Save Cart" feature. You can come back to it at another time if you are interrupted or save all of your orders for future reference. These can be activated to be your current order/cart at any time.
- Registration is required. This ensures that only Pool & Spa Dealers and Service Companies, not the general public, can see pricing and use the shopping cart.
- Download the SSC catalog, price list and all of our literature from the website.

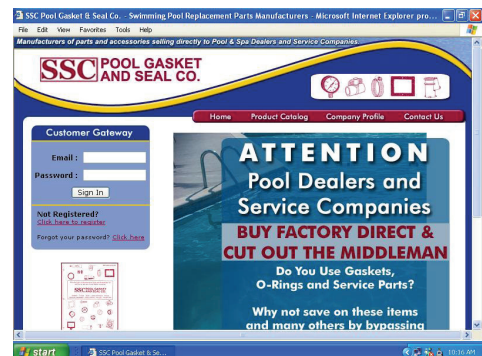

www.poolgasket.com

O-RINGS-LISTED IN SSC# ORDER

SSC#	FITS OEM	FITS OEM#	DESCRIPTION	SSC#	FITS OEM	FITS OEM#	DESCRIPTION
O-1001	Hayward	DEX2400K	Micro Clear Vertical Fiberglass Tank O-ring		Universal	--	Filter Tank O-ring
O-1002	Sta Rite	24700-73	24" DES-51 & 60 Tank O-ring	O-1040	Wet Inst.	--	Tank O-ring
O-1004	Sta Rite	24240-04	Cobra & Falcon Body O-ring	O-1041	Swimrite	--	50-57 Verticle Filter O-ring
O-1006	Sta Rite	U9-175	Separation Tank O-ring	O-1041	Doughboy	308-1000	Tank O-ring
O-1007	Sta Rite	24753-05	DEP-25 216, 108, 72 Cartridge O-ring-Fits 16"		Doughboy	308-1056	Tank O-ring
O-1008	Miami	--	20" CF-104 Tank O-ring		Doughboy	MY220-RP	Pump Gasket
	Sta Rite	U9-160	20" Tank O-ring		Muskin	037-3434	16" Tank O-ring
O-1009	Sta Rite	24751-05	24" DEP-51 Fiberglass Filter O-ring	O-1042	Tank	--	16" Tank O-ring
O-1010	Jacuzzi	13-0220-09	Flange O-ring		American	550017	24" Tank O-ring
	Jacuzzi	47-0448-05	O-ring		Premier	25-745	24" Tank O-ring
	Sta Rite	35505-1365	O-ring		Sta Rite	U9-165	24" Tank O-ring
	Sta Rite	WC9-003	Cartridge Filter Tank O-ring		Swimrite	28-828-745	24" Satellite tank O-ring
O-1011	Sta Rite	U9-200	PLBC Tank O-ring		Tank	--	24" Tank O-ring
	Sta Rite	U9-389	PLBC Tank O-ring	O-1043	Sta Rite	23382-13	Model X Filter O-ring
O-1012	Doughboy	308-1075	O-ring	O-1044	Hayward	SX0240Z1	Sand Filter Tank O-ring
O-1013	Doughboy	308-1115	O-ring	O-1045	Pentair/PF	--	O-ring
	Lomart	308-1115	Tank O-ring to fit Ultra D.E. Filter	O-1046	Sta Rite	24752-05	30" DEP-83 Fiberglass Filter O-ring
O-1014	American	--	Separation Tank O-ring MS6-72	O-1048	Pentair/PF	17-4704	Mytilus/Turbo Tank O-ring
	American	570032	12" Carbide Filter Tank O-ring		Sta Rite	23568-15	Separation Tank O-ring
	Anthony	04278	Separation Tank O-ring	O-1049	Hayward	SX0160Z1	Sand Filter Tank O-ring
	Anthony	06483	Separation Tank 40/60 O-ring	O-1050	Premier	25-311	6" Pump Lid O-ring
	Premier	27-678	Hercules II Tank O-ring	O-1051	Lomart	053-014	13" Tank O-ring
	Sta Rite	U9-191	Separation Tank O-ring	O-1052	Ampro	1403	14" Tank O-ring
	Swimrite	30-828-678	12" Separation Tank Cartridge Lid O-ring	O-1054	Lomart	053-015	14" Tank O-ring
O-1015	Jacuzzi	47-0569-99	Earth Works Tank O-ring	O-1055	Hayward	CX0800F	800 and 1100 Cartridge Filter O-ring
	Sta Rite	24700-72	20" DES-36, HRS-20 Tank O-ring	O-1055	Jacuzzi	13-0301-01	Tank Clasp O-ring
O-1016	Premier	31-713	7" Lid O-ring		Miami	CF-52	16" Tank O-ring
	Swimrite	60-828-713	7" Stainless Steel Pump Lid O-ring-24.5" C/L	O-1056	Pentair/PF	15-2038	22" Tank O-ring
O-1017	Ampro	3015-83	Tank O-ring	O-1058	Lomart	053-074	16" Tank O-ring
O-1018	Swimrite	70-828-827	Large O-ring	O-1059	American	570073	Commander Tank O-ring
O-1019	Diaclear	C-46181	ES-7 Cover O-ring		Sta Rite	WC9-011	Cartridge Filter O-ring
O-1020	Saurerman	--	Small Tank O-ring	O-1060	American	--	Bottom Seal For Carbide 52/104 Sq. Ft.
O-1021	Baker Hyd	00B7037	Tri-Filter Lid O-ring		American	390022	Power Pump Body O-ring
O-1022	South Pac.	--	Old Style White Lid O-ring		American	570031	10" Sep. Tank O-ring
O-1023	Coleco	33510	Fiberglass Tank O-ring	O-1061	Wet Inst.	32-050-715	18" Tank O-ring for DE Filter
O-1025	Anthony	12382	Ditron Tank O-ring	O-1062	Pentair/PF	15-2127	18" Tank O-ring
O-1026	Saurerman	--	Large Tank O-ring	O-1063	Landon	--	Separation Tank O-ring
O-1027	South Pac.	--	New Style Brown Lid O-ring		Lomart	--	Separation Tank O-ring
O-1028	Starbright	--	SEP Tank O-ring		Purex	71441	CF-25, 50 & 700 Tank O-ring
O-1029	Purex	71439	SM 4000 Tank O-ring		Purex	P-24275	Filter Lid O-ring
O-1030	Hayward	--	Goldmarc Model 181 & 241 Cover O-ring		Swimrite	38-828-680	10" Separation Tank O-ring
O-1031	Pentair/PF	--	9/16" X 67 1/2" Tank O-ring	O-1064	Lomart	053-110	11" Tank O-ring
O-1032	Sta Rite	U9-105	11" Trap Lid O-ring	O-1065	Doughboy	308-1156	15" Tank O-ring
O-1033	Sta Rite	24700-74	Tank O-ring		Lomart	053-213	Tank O-ring
O-1034	Muskin	54061	Tank Gasket	O-1066	Doughboy	308-1141	Filter Tank O-ring
O-1035	Swimrite	60-828-713	7" Stainless Steel Pump Lid O-ring-21.25" C/L		Lomart	053-097	14" Tank O-ring
O-1036	Sta Rite	U9-259	Sep. Tank O-ring		Tank	--	14" Tank O-ring
O-1037	Anthony	17434	A-40 O-ring	O-1067	Purex	71433	C-18 Cover O-ring
	Pentair/PF	19-5008	Old Style Tank Lid O-ring	O-1069	Marine	7650-3	6 3/4" Clear Pump Lid O-ring
	Starbright	--	20" Tank O-ring	O-1070	Pentair/PF	31-3225	Mitra 11" Tank O-ring
O-1038	Sta Rite	23383-15	X Model Tank O-ring	O-1071	Pentair/PF	15-2235	16" PF-100 Tank O-ring
O-1039	American	530028	18" Tank O-ring	O-1073	Jacuzzi	47-0214-49	Earth Works Filter O-ring
	Anthony	17433	18" Tank O-ring		Purex	71442	2000 Series Tank O-ring
	Marine	5260	Tank O-ring		Swimrite	28-828-687	18" Ventirite Tank O-ring
	Muskin	037-3410	18" Tank O-ring	O-1074	Purex	71443	800 Series Tank O-ring
	Premier	23-671	18" Hercules Tank O-ring	O-1076	Richardson	5099-135	22" Filter Tank O-ring
	Premier	27-671	18" Tank O-ring	O-1077	Marine	3760	Tank O-ring
	Purex	71437	CF-100 Tank O-ring	O-1080	Marine	1600	Tank O-ring
	Sta Rite	U9-145	18" Tank O-ring	O-1082	American	390060	Ultra Flow Pump Volute O-ring
	Swimrite	28-828-671	18" Filter Tank O-ring		Aqua Flo	92200180	O-ring
					Martec	320-110	Pool Master Housing O-ring
					Sta Rite	35505-0422	Seal Plate Housing O-ring
					Sta Rite	U9-228	Dura Glass Pump Clamp O-ring
				O-1083	Premier	25-744	15" Atlas DE Filter Tank O-ring
					Speck	2991300003	Badustar 913 Lid O-ring
				O-1084	Sta Rite	24700-69	Tank O-ring

O-RINGS-LISTED IN SSC# ORDER

SSC#	FITS OEM	FITS OEM#	DESCRIPTION	SSC#	FITS OEM	FITS OEM#	DESCRIPTION
O-1085	Pentair/PF Superflow	15-2038-3	Tank O-ring PF-50, SCS	O-1148	Muskin	54069	18" Resin Tank O-ring
O-1087	Pentair/PF Superflow	15-2038-2	Tank O-ring PF-50, SCS	O-1149	Muskin	72032	14" Metal Tank O-ring
O-1090	Doughboy Lomart Marine Starbright	308-1142 053-174 5740 --	20" Tank O-ring Tank O-ring MS Tank O-ring Tank O-ring	O-1150	Sundance	6560-043	Hi Flo Heater O-ring
O-1091	Swimrite	64-828-946	10" Series II Gasket	O-1151	Sta Rite	24750-0006	HRPB O-ring
O-1093	Purex	71442R	Tank O-ring-Red Line CF-100, SM-1000, 2000	O-1152	Richardson	5099-125	18" Tank O-ring
O-1095	Hayward Universal	GMX0600FST --	Threaded Filter/Valve Lid O-ring Universal Skid Pack Filter Tank O-ring	O-1153	Richardson	4546-001	Cartridge O-ring
O-1099	Hayward	DEX0360K	Micro Clear DE Vertical S/S Filter Tank O-ring	O-1154	Purex	73270	Filter Tank O-ring
O-1100	Pentair/PF	19-5310	Filter Tank O-ring	O-1155	Sta Rite	24751-0006	HRPB O-ring
O-1101	Jacuzzi	42-2927-06	Dial Valve & Sandtrap Filter Adapter Valve O-ring	O-1156	Sta Rite	24752-0006	HRPB O-ring
O-1102	Muskin Tank	54066 --	15" Tank Lid O-ring 15" Tank O-ring	O-1157	Sta Rite	27001-0060S	System 3 Cord O-ring (Pre-3/97)
O-1106	Hayward Muskin Sta Rite	SX0200Z7 037-3430 24750-05	S-200 Filter Tank O-ring 20" Tank O-ring 20" DEP-36 Fiberglass Filter O-ring	O-1158	Anthony	6527	Separation Tank O-ring
O-1110	Tank	--	20" Tank O-ring	O-1160	Jandy	R0350600	C Series Cartridge Filter Tank O-ring
O-1114	American	550015	Sandpiper Tank O-ring (Before 11-94)	O-1161	Jandy	R0357800	CL Series Cartridge Filter Tank O-ring
O-1115	Tank	--	17" Tank O-ring	O-1162	Sta Rite	27001-0061S	Filter O-ring
O-1116	Jacuzzi	13-0417-02	Cartridge Filter Cover O-ring	O-1163	Sta Rite	35505-0421	Trap Lid O-ring
O-1117	Sta Rite	23383-13	SilverSeal, Capri Tank O-ring	O-1164	Sta Rite	24850-0008	21" Multimedia Filter O-ring
O-1118	Sta Rite	24700-71	Tank O-ring	O-1205	American	191016	O-ring
O-1119	Lomart Richardson Richardson Tank	053-131 -- R-44 --	Tank O-ring 18" Sand Filter O-ring O-ring 18" Tank O-ring	O-1207	American Harmsco	791016 550	Gasket/O-ring Before 1986 11" Rim Gasket/O-ring BF-84, 126 Large
O-1120	Dynapure E-Z Chlor	D-T1 12883-03	Tank O-ring DP Tank O-ring	O-1209	Baker Hyd Gulf Hayward WMC	35B1108 352506230 SPX1600T SS-1600-T	Spa Pak Pump Housing Gasket/O-ring Power Tech Pump Gasket Super Pump Gasket Housing Gasket-AT
O-1121	International	6291-9	Tank O-ring	O-1210	Baker Hyd Purex	00B7000 70247	Control Plate Gasket/O-ring Control Plate Gasket/O-ring
O-1122	International	6721-9	Tank O-ring	O-1211	American	791085	Spa Light Lens Gasket/O-ring
O-1123	Jacuzzi	13-0428-09	SS-24 Filter Tank O-ring	O-1212	American	791016N	Light Lens Gasket/O-ring-After 1986
O-1124	Lomart	053-146	24" Tank O-ring	O-1215	Hayward	CX0250F	250, 500 & 750 Tank O-ring
O-1125	Jacuzzi	13-0221-08	Flange O-ring	O-1216	Anthony	14118	Double Bead Light Lens Gasket
O-1126	Miami	--	FG18 & FG24 Lid O-ring	O-1217	Universal Hayward	-- SPX3000T	Lens Gasket Super II Pump Housing Gasket/O-ring
O-1127	Landon	--	Stainless Steel Tank O-ring	O-1217	Leslies	SPX3000-T	Hydramax II Housing Gasket
O-1128	Monarch	197989	D7 O-ring	O-1225	Paddock	--	Clamp Type & Combination O-ring
O-1129	Lomart	053-210	O-ring	O-1226	Swimline Universal Gulf Hayward WMC	14118 -- 352506260 SPX1600S AT-1600-S	Gasket Lens Gasket Power Tech Cover Gasket Super Pump Lid Gasket Strainer Cover Gasket-AT
O-1130	Swimrite	28-828-686	Ventirite Series Tank O-ring	O-1227	Sta Rite	WC20-03	6.5" Sep. Tank Gasket
O-1131	Marine	624-5	Sand Filter Tank O-ring	O-2001	American Ampro Hayward Polaris Sta Rite	791169 900-9S SFX0400Z1 9-100-5140	Aqua Luminator O-ring Large Spool O-ring Large Drain Valve O-ring Filter Housing O-ring
O-1132	Swimrite	28-828-689	Marathon Filter O-ring	O-2002	Advance Caretaker Caretaker Harmsco	OV-11-332 413-0640 6340241 930	Plunger O-ring Chlorinator O-ring Union Assembly O-ring Hydrostorm Union O-ring Holding Rod O-ring For BF96/ BF144 Cartridge Filter
O-1133	Sta Rite	24700-68	16" DES-25, HRS-16 Tank O-ring	Jandy	R0339600		Coupling Set O-ring (For Kit Order 2)
O-1134	Doughboy	308-1113	Sand, DE & Silica I Tank O-ring	Landon	--		2" Spin Collection O-ring
O-1135	Doughboy	308-1114	Silica II Tank O-ring	Lomart	--		Spin 2" Coll. O-ring
O-1137	Ampro	3015-82	Cent. 2000 Cover O-ring	Richardson	5099-529		2" Sand Valve Adapter O-ring
O-1138	Richardson	--	22" Tank O-ring	Sta Rite	--		PMKGFV 15-20-25-33 Collection O-ring
O-1139	Richardson	--	Cartridge O-ring	Sta Rite	35505-1424		System 3 O-ring
O-1140	Speck	2991300004	Badustar 913 Cartridge O-ring	Sta Rite	U9-156		2" Return Hub O-ring
O-1141	American	390102	RPM Tank Cover O-ring	Sta Rite	U9-374		Diffuser O-ring
O-1142	American	590210	CM Tank Cover O-ring	Swimrite	--		Lid O-ring
O-1143	American	530088	Quantum Tank O-ring (After 11-94)	Waterco	6340241		Supatuf Pump Union O-ring
O-1144	Hayward	RGX0045G	Regenex Filter Head O-ring				
O-1145	Astral	722R1100110	Light O-ring				
O-1146	Muskin	72031	15" Metal Tank O-ring				
O-1147	Muskin	54068	11" Tank O-ring				

O-RINGS-LISTED IN SSC# ORDER

SSC#	FITS OEM	FITS OEM#	DESCRIPTION	SSC#	FITS OEM	FITS OEM#	DESCRIPTION
O-2003	Fischer Jandy	101W814U01 2300	Chlorinator O-ring Porpoise Hydrotimer Case O-ring		Jacuzzi	47-0129-01	Skimmer Mat O-ring
	Letro Anthony	F-31 17791	Hose Assembly O-ring Brass Push Pull Valve 1.5 O-ring		Jacuzzi	47-0221-08	4 Way Valve Disc Body O-ring
O-2004					Jacuzzi	47-0222-07	PM Filter Valve O-ring
	Polaris Sta Rite	6-505-00 35505-1401	O-ring UWF/QD Index Plate & Piston O-ring- Plastic Pucks		Lomart	053-026	Strainer O-ring
O-2005	Regal	S-408	Chlorinator O-ring		Marlow	--	Diffuser 1/3-1 HP Mardur Pump O-ring
O-2006	Vico Anthony	PPWWVO/R 17438	Volute O-ring Spinfilter End Bell O-ring		Muskin	54072	Filter O-ring
	Hydro Air	--	ADI Flowjet O-ring	O-2022	WMC	JS-1904	JS Pump Strainer O-ring
	Jacuzzi	--	Collection O-ring		Hayward	SPSTX0269Z5B	Hair and Lint Strainer O-ring- 304, 340R
	King	945	King Feeder Control Dial O-ring Kit		Sta Rite	35505-1281	Skimmer O-ring
	Premier	29-225	Return Spin Filter O-ring	O-2023	Hayward	SPX1450M	Turbo Boost Winter/Test Plug O-ring
	Saurerman	--	Manifold O-ring		Tesco	H-301	Widget Upper Case O-ring
	Spin Rite	--	Collection Tube O-ring	O-2024	Acura	1058	Magna Drain Plug O-ring
	Swimrite	28-828-678	Spin Filter Manifold O-ring		American	--	Separation Tank Air Relief Valve O-ring
O-2007	Doughboy	308-1125	Cyclops Strainer Cover O-ring		American	510031	Stem & Shaft Cap O-ring
	Hayward	SPX1500P	Power Flow Pump Lid O-ring		Anthony	17437	Valve Shaft O-ring
	Jacuzzi	47-0354-07	U Series Pump O-ring		Doughboy	308-1009	Air Relief Fitting O-ring
	Lomart	053-159	Strainer O-ring		E-Z Chlor	12690-09	Flow Meter Gasket
	Muskin	54071	Hair & Lint Pot O-ring		Jacuzzi	20-1010-00	RTC Pump O-ring
	Poolco	3XL SCOR	Strainer Cover O-ring for Vortex Pump		Jacuzzi	47-0112-00	Stem & Crank O-ring
	Sta Rite	35505-7430	O-ring		Jacuzzi	47-0112-99	Plug O-ring
O-2008	American	--	1 1/2" Collection O-ring		K-D Pools	47-0112-00	Sand Filter O-ring
	Anthony	--	Piston O-ring		Letro	LL-14	Gear Assembly O-ring
	Hayward	SPX0410Z1	SP410X Piston O-ring-Small		Letro	P-40	Hose Assembly O-ring
	Jacuzzi	47-0328-00	Splash Pak O-ring		Marine	--	Valve Stem O-ring
	Laars	S-690	Heater O-ring		Martec	201-010	Drain Plug O-ring
	London	--	Spin 1 1/2" Collection O-ring		Martec	205-104	Bleeder O-ring
	Paddock	--	Petite Spin Filter Tube O-ring		Pentair/PF	--	Crankshaft O-ring
	Pentair/PF	27-4494	Valve Adapter O-ring		Pentair/PF	02-112	Crankshaft O-ring
	Sta Rite	U9-154	1 1/2" Return Filter O-ring		Pentair/PF	27-3011	Brass Valve Shaft O-ring
O-2009	Danner	--	Model 350 Cover Pump O-ring		Polaris	E-45	Backup Valve Plate O-ring
	Jacuzzi	47-0131-07	Gyro Flo O-ring		Polaris	P-40	Pump Shaft O-ring
	Jacuzzi	47-0331-05	O-ring		Premier	--	Crank O-ring
	Premier	31-157	300 Series Swivel O-ring		Premier	29-113	Series 220 Shaft Extension & Crank O-ring
	Saurerman	--	1 1/2" Tube O-ring		Purex	72555	Ortega Valve Stem O-ring
	Sta Rite	35505-1175	Valve Connector O-ring		Raypak	--	Manual By-Pass O-ring
	Sta Rite	U9-245	Plunger Top O-ring		Speck	2923541220	Pump Housing O-ring
	Waterway	805-0132	Polyjet O-ring		Spin Rite	--	Crank O-ring
O-2010	Speck	2920741270	Model 423 Tank O-ring		Sta Rite	U9-147	Bronze Cap Valve O-ring
	Sta Rite	--	Unitrol Valve Piston O-ring		Sta Rite	U9-359	Posi Flo II Air Release O-ring
	Sta Rite	35505-1318	Piston Plastic Slide Valve-2"		Swimrite	28-828-675	Spin Crank O-ring
O-2011	Arneson	W-430	Leaf Cannister O-ring		Swimrite	30-828-750	1 1/2" x 1 1/2 Shaft O-ring
	Astral	7731520035	Astra Max O-ring		Swimrite	30-828-756	1 1/2" V Crank Pump O-ring
	Pool sweep	W-430	Leaf Cannister O-ring		Universal	--	Stem & Crank O-ring
	Tesco	H-301	Widget Lower Case O-ring		Vico	PPULPLUGOR	Ultrajet Pump Plug O-ring
O-2012	American	371017	Lid O-ring		Waterway	805-0111	Center Discharge Pump O-ring
	American	391017	Americana II Lid O-ring	O-2025	American	510022	1 1/2" O-ring
	Muskin	72201	Valve Bottom O-ring		Aqua Flo	92200200	Flo Master, Tubmaster Volute O-ring
O-2015	Jacuzzi	47-0233-04	H4 Booster O-ring		Astral	711R1329035	Chemical Feeder O-ring
	Pentair/PF	35-5331	Challenger Diffuser O-ring		Astral	7731329035	Astra Max O-ring
O-2017	American	501415	1 1/2" Multiport Valve T/M Series Lid O-ring		Baker Hyd	30C3005	1 1/2" Multiport Valve Cover O-ring
	Doughboy	308-1005	3/4 HP Pump O-ring		Hayward	SPSTX0266Z5B	Hair and Lint Strainer O-ring- 320, 325, 320R, 325R
O-2018	Anthony	LL	Lens O-ring		Hayward	SPX0710Z3	Valve Lid O-ring (Prior to 1976)
	Kim	--	Lens O-ring		Jacuzzi	47-0236-01	Splash Pak Valve Cover O-ring
O-2019	Sta Rite	35505-1007	Hydro Valet Face Plate Inlet O-ring		Leslies	SPX0710-Z-3	Hydramax A/G O-ring
O-2020	American	--	Americana Spacemaker Collector O-ring		Martec	300-004	Wet End O-ring
	Baker Hyd	301560	Old Spa Pak Pump Gasket		Pentair/PF	27-1103	Valve Cover O-ring
	Hayward	SPX1491B	Econo Union O-ring		Poolco	2XLXLV BHOR	Pump Housing O-ring
	Hercules	760502	Heater Element O-ring		Sta Rite	--	PDC Bottom O-ring
	Hyprime	--	Small Impeller O-ring		Sta Rite	35505-1408	XL-VII Pump Volute O-ring

O-RINGS-LISTED IN SSC# ORDER

SSC#	FITS OEM	FITS OEM#	DESCRIPTION	SSC#	FITS OEM	FITS OEM#	DESCRIPTION
	Waterway WMC	805-0252 JS-3701	Bath Pump Volute O-ring JS Pump Housing O-ring-Side Discharge		WMC	JS-1701	Pump Housing O-ring-Center Discharge
O-2026	American American Premier Vico Wet Inst. Wet Inst.	397018 397028 31-159 PPUFVOR -- 34-050-312	Pump O-ring 6 3/4" Bronze Pump O-ring Volute O-ring Ultrajet O-ring Seal Plate O-ring Bracket O-ring	O-2042	Ampro Sta Rite Sta Rite	-- 35505-1263 35505-1401	Large O-ring for Spool 900-8S, 900-7S 1 1/2" Piston O-ring-Brass Pucks-Old Style Index Plate & Piston O-ring- Brass Pucks
O-2028	Pentair/PF Pentair/PF Pentair/PF Swimrite	-- 35-2602 35-2604 60-828-486	5" H & L Trap O-ring New Style 5" H & L Trap O-ring 590 Glass Pump Lid O-ring 5" Clear Lid Gasket	O-2044	Purex Sta Rite	72554 U9-240	Ortega 2" Cover Seal O-ring Pump O-ring
O-2029	Swimrite	28-828-668	Ret. End Bell O-ring	O-2046	Pentair/PF	35-5329	Old Style Challenger Housing O-ring
O-2030	American	570113	Commander II In-Line Cartridge Filter Drain O-ring	O-2047	Sta Rite Hayward	31935-0001 SPX4000T	Posi Flo II Lid O-ring Seal Plate O-ring for Northstar Pump
	Purex Sta Rite	72553 U9-239	Ortega 1 1/2" Cover Seal Pump O-ring	O-2049	Sta Rite Hayward Jacuzzi	U9-301 SPX1070Z2 47-0143-03	Posi Flo Top O-ring Float Valve O-ring 2" Multiport Valve O-ring (After 8/73)
O-2032	Aqua Flo Astral Pentair/PF	92200020 721R180060 --	8" Trap Cover O-ring-AC Persius Sand Filter O-ring 8" Trap Lid O-ring		Jandy King	6749 106-000-016	Valve O-ring King Tech New Style Cap O-ring
O-2034	Premier Jacuzzi	39-441 47-0268-02	8" Trap Lid O-ring PM Filter Top O-ring		King Waterway	122 --	King Feeder Cap O-ring Quad Flo Jet O-ring
O-2038	Purex Doughboy	71448 308-1134	Valve Body O-ring Pro X Backwash Valve Cap O-ring	O-2051	Blue White Hydro Air Lomart	9003-058 -- 053-075	Chlorinator O-ring Air Control O-ring Tube O-ring
	Lomart	053-044	Back Wash Cap O-ring, Pro Pump Diffuser O-ring		Regal	S-413	Chlorinator O-ring
	Swimrite Waterway	28-828-021 805-0140	O-ring Power Jet O-ring	O-2053	American Hydro Air	469250 10-3953	Mini Air Control O-ring Jet Assemblies O-ring
O-2040	American	391029	Titan O-ring, Sandpiper O-ring (Current Version)		Martec Waterway	410-504 805-01205D	O-ring Top Load Filter O-ring
	Baker Hyd	00B7027	Old Style Bulkhead Adapter O-ring	O-2054	American American American	393003 393006 510116	Pump Lid O-ring Locking Ring Lid O-ring Eclipse Valve O-ring
	Coleco Hayward Hyprime	33185 SPX1495Z1 --	Cover O-ring Ball Valve Flush Union O-ring Large Impeller O-ring		American Jacuzzi	520005 47-0439-06	Eclipse O-ring Cast Iron PJM Lid O-ring
	Jacuzzi Jacuzzi	47-0227-02 47-0227-36	Gyro-Flo O-ring Gyromat B/W Lower Valve O-ring		Swimrite Wet Inst.	60-828-487 --	7" Clear Lid Gasket Pump Lid O-ring
	Marlow Monarch	43117 --	Argonaut Diffuser O-ring Old Time Impeller O-ring	O-2056	Hayward Speck	SX0220Z2 2991300002	Bulkhead Fitting O-ring Badustar 913 Diff. O-ring
	Pentair/PF Purex	27-3062 70213	2" PVC Valve Cap O-ring Old Style Bulkhead Union O-ring-00B7027	O-2058	Hayward Jacuzzi Jacuzzi	GMX0600F 47-0364-05 47-0364-47	Filter Tank Lid O-ring Dial Valve O-ring Magnum Pump Housing O-ring
	Purex Raypak Raypak	72559 -- --	1 1/2" Ortega Valve Cap O-ring U-G #H O-ring Solar Valve Body Union O-ring	O-2059	Premier Richardson Jacuzzi	25-313 5535-101 47-0352-41	8" Sidewinder O-ring Sand Filter O-ring Lid O-ring
O-2041	Sta Rite Acura Aqua Flo Doughboy Doughboy Gulf Jacuzzi Martec Pentair/PF Pentair/PF Premier Purex Rainbow Rainbow Rainbow Sta Rite Sta Rite Sta Rite Sta Rite Sta Rite Swimrite Waterway	35505-1428 1059 FCF-11 308-1038 308-1099 352507091 47-0256-06 201-004 15-4493 15-4495 31-256 71422 18608 21-1236 21-1366 -- -- 35505-1272 35505-1273 35505-1409 70-828-828 805-0256	Elbow Assembly O-ring Aquaheat Large Pump O-ring O-ring PPI Diffuser O-ring Power Tech 2 Housing O-ring PM Filter Valve O-ring Filter Body O-ring Filter Dome Lid O-ring Triton II Closure O-ring O-ring Aquatron Lid O-ring Leaf Trap O-ring 180 Leaf Trap Lid O-ring In Line Leaf Trap Lid O-ring Delrin and Sand O-ring Sand Filter Cover O-ring O-ring Float Valve O-ring Skimmer Lid O-ring Small O-ring Bath Pump Volute O-ring		K-D Pools Pentair/PF	47-0352-41 27-2708	LR6 Strainer Cover O-ring Filter Top O-ring/Valve Body O-ring
				O-2060	Speck American Pentair/PF	2020341210 392041 35-0013	O-ring Eagle Pump Lid O-ring, Filter O-ring Challenger High Pressure Pump Lid O-ring
					Premier Sta Rite Waterway	P-136P U9-229 805-0436	New Style Clear Lid O-ring Dura Glass Pump Lid O-ring 6" Trap Lid O-ring
				O-2066	American International Pentair/PF	391016 -- 19-1517	Americana II Body O-ring Manifold O-ring Star 50 DE Standpipe O-ring
				O-2067	American	510183	2" Multiport Valve Threaded O-ring
					Ampro Aqua Flo Aqua Flo	200-36 92200050 CF-11	Lexan Pump Body O-ring C Series Volute O-ring C Series Volute O-ring, Dominor O-ring
					Hayward Purex	SPX0715Z1 71447	Multiport Valve Cover O-ring PA Series Pump O-ring

O-RINGS-LISTED IN SSC# ORDER

SSC#	FITS OEM	FITS OEM#	DESCRIPTION	SSC#	FITS OEM	FITS OEM#	DESCRIPTION	
O-2068	Sta Rite	U9-243	Cover O-ring				O-ring, Maxim Pump O-ring	
	Advance	OV-11-325	Chlorinator O-ring		Doughboy	308-1001	Manifold Seal O-ring	
	American	510050	2" B/W Valve Piston O-ring		Hayward	ECX1321A	Micro Star Air Relief Valve O-ring	
	Marine	5280	Bearing & Manifold O-ring					
	Pentair/PF	15-2122	O-ring		Hayward	SPX1082Z410	Star Clear Relief Valve O-ring	
	Pentair/PF	27-3090	2" Slide Valve O-ring		Jacuzzi	47-0110-02	Valve & Filter O-ring	
O-2071	Premier	--	2" Backwash Valve Valve O-ring	Pentair/PF	27-3060	2" PVC Valve Shaft O-ring		
	Pentair/PF	19-1424	Star 40/ Mytilus Bottom Piping O-ring	Purex	71436	Sel. Valve Shaft O-ring		
O-2079	Speck	2920141210	Casing O-ring, 410 Lid O-ring, Etc.	Sta Rite	35505-1152	Dial Valve Shaft O-ring		
	American	391015	Body O-ring	Sta Rite	U9-221	WC-212-7 Valve Cap O-ring		
O-2080	Homelite	62772	O-ring	Swimrite	30-828-670	Valve Stem O-ring		
	Hydro	PO-0050	Dynamic Pump Volute O-ring	O-2091	Hayward	SX0200Z6	Sand Filter Lid O-ring	
O-2082	Purex	71418	JT Adapter O-ring	Nature 2	2-13061	Cap O-ring		
	American	390004	Power Pump Lid O-ring	Pentair/PF	27-5333	Valve Body O-ring TA100D		
	Jacuzzi	--	U25B Lid O-ring	Speck	2920141220	410 Casing O-ring		
	Jacuzzi	47-0434-01	Magnum Pump Lid O-ring Prior to 7/89	Speck	2991300001	913 Casing O-ring		
	Pentair/PF	35-2600	Old Style 700 Lid O-ring, Hydro O-ring	O-2092	Ampro	900	Small Spool O-ring for 900-7S, 8S	
	Pentair/PF	35-3525	New Style Porpoise Clear Lid O-ring				System 3 Sand Adapter O-ring	
O-2086	Pentair/PF	35-5332	New Style Challenger Pump Lid O-ring	O-2093	Anthony	--	1 1/2" Old Style Piston Ring	
	American	--	Crank O-ring	Baracuda	67600		Zippy/Zippy Pure Wall Adapter O-ring	
	American	390100	Impeller O-ring				1 1/2" Old Style Piston Ring	
	American	470642	Titan Lid Fitting O-ring	O-2094	Blue Haven	--	Valve Body O-ring	
	American	477210	Cyclojet Small O-ring	Astral	721R1820060		Tank O-ring-16, 20, 24	
	Aqua Flo	92200070	O-ring	Baker Hyd	15B3315		H&L Strainer O-ring	
	Arneson	F-07	Poolsweep O-ring	Jacuzzi	47-0442-01		2" DV Cover O-ring	
	Baker Hyd	31B0035	Index Plate O-ring	Jacuzzi	47-0464-04		Argonaut Bracket O-ring	
	E-Z Chlor	168092	Top Flowmeter O-ring	Marlow	44802		Valve to Tank O-ring for Filters	
	E-Z Chlor	824092	Top Flowmeter O-ring	Poolco	16TVT		Pool Heater Manifold O-ring	
	Landon	--	Crank Shaft O-ring	Sta Rite	35505-7432S		V/F Tank Flange O-ring	
	Letro	LF-07	O-ring	Sta Rite	U9-369		Plate to Volute O-ring	
	Lomart	--	Crankshaft O-ring	O-2095	American	392003	25 Sq. Ft. Lid O-ring	
	Muskin	27-2511	Diverter Shaft O-ring	Baker Hyd	17B1087		Cartridge Filter Lid O-ring	
	Pentair/PF	19-2115	RM Spin Filter Crank O-ring	Hayward	CX0120D		CFT 25 Filter O-ring	
	Purex	70156	O-ring	Jacuzzi	47-0360-09		Pro Pump Cover O-ring	
	Rainbow	17-2393	DSF Skimmer Access Plug O-ring	Lomart	053-200		25 Sq. Ft. Filter Lid O-ring	
	O-2087	Sta Rite	--	31B0035 Index Plate O-ring	Rainbow	17-2223		XL-VII Pump O-ring
		Sta Rite	--	Index Plate Small O-ring	Sta Rite	16920-12		Top Load Filter Lid O-ring
Sta Rite		--	31B0035 Index Plate O-ring	Waterway	568-0360		Top Load Filter Lid O-ring	
Sta Rite		35505-1116	Piston Assembly O-ring	Waterway	805-0360		Strainer Cover O-ring	
Waterway		805-0014	Hi-Flo Pump Drain Plug O-ring	WMC	JS-1903		Vari Flo Nozzle O-ring	
Brett		60-0001	EM103 Heater & Pump O-ring	O-2096	Hayward	SPX1434J	Dial Valve O-ring	
Hydro Quip		60-0001	Heater Element O-ring	Sta Rite	35505-1121		Pro Jet O-ring	
Hydropump		HL4	4" H&L Trap O-ring	Hayward	SPX1438H		Timer O-ring	
Jacuzzi		47-0349-06	PJM Cap O-ring	Polaris	9-100-5132		4" H&L Trap O-ring	
Muskin		54064	Strainer Pump Lid O-ring	O-2099	Anthony	HL4	Strainer Cover O-ring	
Purex		71420	O-ring for Soltron	Diaclear	C-30082-MS		4" Pump Lid O-ring	
O-2088	Sta Rite	35505-1437	ABG Pump Trap Lid O-ring	Premier	31-346		4" Pump Lid O-ring	
	Vita	--	Heater Housing O-ring	Sta Rite	U9-045		Pump Cover O-ring	
O-2089	Anthony	11027	Conv. Kit O-ring	Sta Rite	U9-295		Rear Seal O-ring	
	King	01-22-1926	Cap O-ring	O-2100	Anthony	--	Hydrostorm Pump Diffuser O-ring	
O-2090	Sta Rite	16503-07	Body O-ring	Caretaker	634011		Union Ball Valve O-ring	
	Sta Rite	35505-1266	XLIII Pump Seal Plate O-ring	Hayward	SPX5500K		Strainer O-ring for Powerflow Matrix A/G Pump	
	Baker Hyd	00B7026	Newport Sand Filter Valve Tank O-ring				Diffuser O-ring	
	Caretaker	1131	Large O-ring	Jandy	R0338801		Rear Seal O-ring	
	Jacuzzi	47-0262-08	O-ring	Kim	--		H Series 2 HP Diffuser O-ring	
	Letro	LA-415	Booster Pump O-ring	Marlow	--		AF Diffuser O-ring-3 HP	
O-2091	Lomart	308-1078	Spectra II, Ultima II Valve to Tank O-ring	Marlow	21035		H Diffuser O-ring-2 HP	
	American	467130	Diverta Port Valve Bobbin O-ring	Marlow	25475		1 1/2" Bulkhead O-ring	
O-2092	American	570065	Commander Gauge Plug	Pentair/PF	15-4491		1 1/2" Union O-ring	
				Plastiline	--		Fill Cap & MF23 Tube O-ring	
O-2093				Sta Rite	35505-1317		Old Style Turbo Valve O-ring	
				O-2101	Gould	--	S/W Injector O-ring	
O-2094				Jacuzzi	47-0115-07		Control Well O-ring	
				Laars	--		Crankshaft O-ring	
O-2095				Pentair/PF	--		Valve Shaft O-ring	
				Pentair/PF	15-4287		Control Well O-ring	
O-2096				Raypak	--			

O-RINGS-LISTED IN SSC# ORDER

SSC#	FITS OEM	FITS OEM#	DESCRIPTION	SSC#	FITS OEM	FITS OEM#	DESCRIPTION
O-2103	Sta Rite	35505-1157	Knob O-ring				Coupling O-ring
	Fischer	101W816U01	Chlorinator O-ring	O-2116	Waterway	805-0224	Heater Tailpiece 1 1/2" O-ring
O-2104	Purex	71444	Whisperflo Diffuser O-ring		Conger	--	Mini Air Control O-ring
	Aqua Flo	FF-14-02	Seal Cup O-ring		Hayward	CX0250Z7	Locking Knob Cartridge Filter O-ring
	Doughboy	308-1003	Manifold Bearing O-ring		Hayward	GMX0152Z5	Drain Plug O-ring (After 1979)
	Doughboy	308-1040	Insulator O-ring	O-2117	King	--	Kingfeeder Cam O-ring
	Hayward	SPX1500M	SF400 Small Drain Valve O-ring		Caretaker	6340113	Hydrostorm Diffuser O-ring
O-2105	Muskin	54063	Spider O-ring		Hayward	SPX0724G	End Connector O-ring
	American	472264	Diverter Jet Valve O-ring	O-2118	Laars	R0338805	Diffuser O-ring-3 HP
	Hayward	ECX1287	DE Filter Gauge O-ring		American	477211	Cyclojet Large O-ring
O-2106	American	--	Titan Manifold O-ring	O-2119	Marlow	42925	Gemini O-ring
	American	510035	Sand Filter Union O-ring		Doughboy	308-1059	Dynaflow Cover O-ring
	American	510135	ABS Valve Body O-ring		Luitweiler	--	Pump Lid O-ring
	American	590006	Manifold O-ring	O-2120	American	520001	Eclipse Bulkhead O-ring
	Anthony	--	Bulkhead Connector		American	792071	Hi-Lite O-ring
	Anthony	17790	2" Plastic Valve Union O-ring	O-2121	Astral	723R0700050	Sand Filter O-ring
	Baker Hyd	--	Valve Coupler O-ring		Sta Rite	35505-1323	Roto-trol Valve O-ring
	Baker Hyd	00B7001	Bulkhead Fitting O-ring		Ampro	600-57	H&L Pot Lid O-ring
	Hayward	DEX2400Z5	Outlet Elbow O-ring		Anthony	--	Hydro H&L Lid O-ring
	Jacuzzi	47-0139-09	TP4 Test Plug O-ring		Hydropump	--	5" H & L Trap O-ring
	Pentair/PF	--	PVC Backwash Valve Cap O-ring		Lomart	053-058	Strainer Cover O-ring
	Pentair/PF	--	RPZ Pot to Volute O-ring		Marine	--	5" Clear Plastic H&L Lid O-ring
	Pentair/PF	--	Nautilus Manifold O-ring	O-2122	Pentair/PF	35-4052	540 Pump Lid O-ring
	Pentair/PF	--	Mark Series Center Pipe O-ring		Sta Rite	35505-1338	XLVI Pump Lid O-ring
	Pentair/PF	19-2300	Mytilus Connector & Bulkhead O-ring		Swimrite	--	H&L Lid O-ring
	Pentair/PF	19-2323	Filter & Pump Gasket		Aladdin	O-408	Vac Master Lid O-ring
	Purex	--	CHD O-ring		Doughboy	308-1064	O-ring
	Purex	70238	OOB7001 Bulkhead O-ring	O-2124	Hayward	GMX0142C8	O-ring
	Purex	P-24305	Center Tube O-ring		Hayward	SPX1070Z1	Float Valve O-ring
	Saurerman	--	2" Tube O-ring		Premier	--	550 Noryl Bracket O-ring
	Sta Rite	--	Dep. 83 Valve Adapter O-ring		Advance	OV-11-113	Chlorinator O-ring
O-2107	South Pac.	--	Old Style Brown Lid O-ring		American	--	Multiport Valve Rotor Shaft O-ring
	Sta Rite	U9-171	8" Trap Lid O-ring		E-Z Chlor	--	Flow Meter O-ring
O-2109	Berkely	--	5" H&L Pot Lid O-ring		Fischer	101W711U01	Chlorinator O-ring
O-2110	Sta Rite	U9-244	O-ring		Hayward	ECX2899A	Perflex Pump Shaft O-ring, Small O-ring
	Tesco	F-35	Pure Water Feeder Lid O-ring		Hayward	SPX0722H	Stem O-ring (Prior to 1975)
	Wallace	34497	Chlorinator O-ring (Not Viton)		International	--	Crank O-ring
O-2111	American	390066	Ultra Flow Pump Volute O-ring		Jandy	--	Leaf Trap O-ring
	Sta Rite	35505-1245	Turbo Clean Head O-ring		Letro	JV-18	Jet Vac O-ring
	Sta Rite	U9-362	Valve O-ring-WC212		Letro	LLC140	Thrust Jet O-ring
	Tesco	--	M/A Feeder Cap O-ring		Pentair/PF	27-2406	2" Hi-Flow Valve Shaft O-ring
O-2112	Fiberstars	A9981	Small O-ring		Polaris	C-140	Thrust Jet O-ring
	Marlow	--	Diffuser O-ring		Pool Tender	05-009-1005	O-ring for All Models
	Rainbow	17-2319	320 Chlorinator Base O-ring		Premier	--	Spin Filter Crank O-ring
O-2114	Astral	773R0950050	Sand Filter O-ring		Premier	--	Shaft Extension O-ring
	Coleco	33235	Cover O-ring		Purex	71435	Noryl Rotor Shaft O-ring
	Pentair/PF	15-4005	C-3 O-ring		Purex	71435	O-ring for 2-113
	Rainbow	17-2009	Cartridge Filter Lid O-ring		Raypak	800031	Bypass Manual O-ring
	Sta Rite	35505-1332	O-ring		Regal	S-404	Chlorinator O-ring
	Sta Rite	35505-1425	System 3 O-ring		Regal	S-410	Chlorinator O-ring
O-2115	Amer Gran	50-1100BSS	1 1/2" Heat Sink O-ring		Swimrite	--	Shaft O-ring
	American	510034	Bronze Valve Cap O-ring	O-2125	Wallace	27409	Chlorinator O-ring
	Doughboy	308-1016	Outlet Retainer O-ring		Acura	0430	Power Quip Heater O-ring
	Hayward	SPX1022C	Seal Plug O-ring		Jandy	2614	Energy Filter Bowl O-ring
	Jacuzzi	--	4 Way Valve Upper O-ring		Jandy	3293	Sheer Descent Cover O-ring
	Jacuzzi	47-0224-05	PM Filter Valve O-ring		Johns Man	--	Johns Manville & Amitek O-ring
	Landon	--	Backwash O-ring	O-2126	American	510032	Valve Stem O-ring
	Lomart	--	Backwash Valve O-ring		Premier	21-500	1 1/2" Piston Seal O-ring
	Marine	--	Valve Cap O-ring		Premier	P-7515	1 1/2" Backwash Valve O-ring
	Martec	700-408	1 1/2" O-ring for Tail		Swimrite	30-828-752	1 1/2" Piston O-ring
	Pentair/PF	19-1474	Star DE Filter O-ring		Swimrite	30-828-757	1 1/2" Piston O-ring
	Premier	--	1 1/2" Valve Cap O-ring		Universal	--	Valve Piston O-ring
	Swimrite	28-828-667	Return Hub O-ring	O-2127	Lomart	053-101	O-ring
	Swimrite	28-828-679	Return O-ring	O-2128	Aqua Flo	92200190	Dominator Trap Lid O-ring
	Waterway	--	Return Fitting O-ring, Fitting		Astral	722R1362035	Top Mount M/V Lid O-ring
					Astral	722R1362035	Multiport Valve Lid O-ring

O-RINGS-LISTED IN SSC# ORDER

SSC#	FITS OEM	FITS OEM#	DESCRIPTION	SSC#	FITS OEM	FITS OEM#	DESCRIPTION
	Hayward	SPX0704F	1 1/2" Vari-Flo Cover O-ring	O-2139	AldenLeeds	O-6030	Divert-O-Trol Chlorinator O-ring
	Hayward	SPX0710XZ3	Vari-Flow Lid O-ring (After 1976)		Jacuzzi	47-0353-08	O-ring
	Hayward	SPX0710XZ5	Housing O-ring for Powerflo Matrix Pump		Jacuzzi	47-0353-40	Strainer Cover O-ring
	Hyprime	--	Lid O-ring		Pentair/PF	07-5848	Commercial R Diffuser O-ring
	Muskin	54079	Large Filter O-ring		Pentair/PF	35-4533	Dynamo, Dynamite Cover O-ring
	Sta Rite	--	Delrin Hi Prime H&L O-ring	O-2140	Marlow	30156	1/2 & 1/3 HP Series Pump Diffuser O-ring
O-2129	Sta Rite	U9-207	Cover O-ring	O-2141	Aqua Flo	92200060	O-ring
	American	423160	Super Flo II Cartridge Filter Knob O-ring		Blue White	9003-030	Chlorinator O-ring
	American	570067	Commander Knob Seal O-ring		Doughboy	308-1011	Volute O-ring
	Grid	3008	Diverter O-ring		Hayward	SPX0602Z2	Valve O-ring
O-2131	Regal	S-406	Chlorinator O-ring		Hayward	SPX1441Z1	Valve Stem O-ring
	Jacuzzi	47-0126-04	DB3 Sleeve O-ring		Hustler	A111	Small O-ring
	Regal	S-407	Chlorinator O-ring		Paraport	C64057	Bleeder Adapter O-ring
O-2133	American	510012	Multiport Valve Shaft O-ring		Pentair/PF	15-4661	Gauge & Air Bleeder Adapter
	Hayward	SPX0603Z2	Stem O-ring		Purex	--	CHD Crank O-ring
	Hayward	SX0200Z5	Filter O-ring		Rainbow	33-0017	Dynamic Chlorinator O-ring
	Muskin	--	4 Way Valve Shaft O-ring		Saurerman	--	2" Tube O-ring
	Muskin	54062	Axle & Valve Shaft O-ring		Speck	2302002062	Baduget O-ring
	Paddock	--	Petite Spin Filter Crank O-ring		Speck	2920141240	Model 90 Drain Plug O-ring
	Pentair/PF	15-4827	Air Relief O-ring		Speck	412.9	Model 420 Drain Plug O-ring
	Swimrite	38-828-752	Cap O-ring		Sta Rite	P64-057	Paraport Valve Seal O-ring
	Waterway	715-1001	Air Relief O-ring	O-2142	American	--	Commander 1 1/2" Volute Piston O-ring
	Waterway	805-0114	Top Load Filter Air Bleeder O-ring		American	510104	Old Style Piston O-ring
O-2134	A.O. Smith	98198	Heater By-Pass O-ring		Anthony	17606	1 1/2" Piston & Valve Cap O-ring
	A.O. Smith	99660	Heater By-Pass O-ring		Coleco	31992	Top O-ring
	American	467150	Diverta Port Valve Puck O-ring		Conger	--	Large Air Control O-ring
	Doughboy	308-1006	Piston O-ring		Jacuzzi	47-0220-09	Test Plug O-ring-TP1
	Hayward	SPX1434TP	O-ring		Marine	--	Valve Piston O-ring
	Jacuzzi	47-0326-02	Sand Trap Plug O-ring		Premier	--	Premier 1 1/2" Cap O-ring
	Lomart	053-050	Backwash Valve O-ring		Sta Rite	35505-1233	Index Plate O-ring
	Marine	--	Valve Piston O-ring		Sta Rite	U9-151	1 1/2" Piston O-ring
	Muskin	037-3414	Valve O-ring		Sta Rite	U9-174	1 1/2" Valve O-ring
	Muskin	038-5434	O-ring		Sta Rite	U9-376	Maxiglas II Shaft O-ring
	Polaris	9-100-5139	Wall Bushing O-ring		Swimrite	30-828-752	Valve Cap O-ring
	Praher	T15-E6	Diverter O-ring		Swimrite	30-828-758	Autoflow Cap O-ring
	Premier	P-2P	2" Piston O-ring	O-2143	Hayward	SPX1705Z1	Pump Housing O-ring
	Raypak	800104	Raytemp O-ring For Piston Valve		Jacuzzi	47-0257-05	Separation Tank Support O-ring
	Richardson	--	Sand Filter Valve Adapter O-ring		Leslies	SPX1705-Z-1	Hydramax A/G Housing O-ring
	Sta Rite	35505-1313	2" Piston O-ring		Premier	31-162	Booster Pump Volute O-ring
	Sta Rite	U9-152	2" Valve O-ring	O-2144	Arneson	J-04	Valve Body O-ring
	Sta Rite	U9-371	Drain Cap O-ring		Hayward	GMX0600D	Teflon Bearing Washer O-ring
	Swimrite	30-828-753	2" Piston O-ring For Autoflow Valve		Hydro Air	10-5834	Mark II Jet Assembly O-ring
	Swimrite	30-828-759	2" Piston O-ring		Letro	LJ-04	O-ring
O-2135	American	--	Commander Air Relief O-ring		Polaris	D-24	Quick Connect O-ring
	Arneson	F-24	Backup Extension O-ring		Poolswep	J-04	O-ring
	Astral	721R0089019	Bolt O-ring		Purex	71430	O-ring
	Blue White	9003-009	Chlorinator O-ring	O-2146	Ampro	300-6	Noryl Pump Body O-ring
	Doughboy	308-1152	Valve Cover Plunger O-ring		Caretaker	413-0575	3/4-2 HP Diffuser O-ring
	Hayward	ECX9611246	EC Filter Bump Shaft O-ring		Caretaker	634017	Hydrostorm Mounting Bracket O-ring
	Letro	LF-24	O-ring		Doughboy	308-1137	Lid Bushing O-ring
	Lomart	053-019	Shaft O-ring		Jacuzzi	47-0264-06	5-Watt Valve O-ring
	Lomart	053-049	Valve Cover Plunger O-ring		Jandy	R0338700	High Head Pump Body O-ring
	Rainbow	17-2221	RTL Filter Air Vent Valve O-ring		Lomart	053-180	Pro Pump O-ring
	Rainbow	17-2224	O-ring		Muskin	54065	9" Plastic Tank O-ring
	Sta Rite	--	MK23 Crank O-ring		Muskin	72033	9" Plastic Tank O-ring
	Sta Rite	25575-0114	Drive Shaft O-ring	O-2149	Aqua Flo	92200290	FMXP Pump Volute O-ring
	Sta Rite	35505-0114	Crank Shaft O-ring	O-2150	American	860069	RPM Bulkhead O-ring
O-2137	King	106-100-007	King Tech Old Style Cap O-ring		Doughboy	308-1150	O-ring
	King	119	Old Style Cap O-ring		Hayward	SPX0410Z2	SP410X Large Piston O-ring
O-2138	Premier	31-160	100 Series Adapter O-ring		Lomart	053-185	O-ring
	Purex	71416	Eastside Seal Plate O-ring		Pentair/PF	19-2122	1 1/2" Return Filter O-ring
	Sta Rite	35505-1263	XLII Pump Seal Plate O-ring		Sta Rite	--	Vertifilter Manifold O-ring
					Sta Rite	U9-285	Trap Adapter O-ring

O-RINGS-LISTED IN SSC# ORDER

SSC#	FITS OEM	FITS OEM#	DESCRIPTION	SSC#	FITS OEM	FITS OEM#	DESCRIPTION
O-2152	Astral	723R0049003	Persius Sand Filter O-ring		Purex	72551	Mixing Valve Liftlock O-ring
	Doughboy	308-1039	Hose Adapter O-ring		Sta Rite	35505-0198	3 Port Actuator O-ring
	Hayward	SPX1500W	Strainer Connector O-ring	O-2177	American	470628	Luxury Spa Jet O-ring
	Leslies	SPX1500-W	Hydramax A/G Strainer O-ring		Cal Pump	--	Volute O-ring-A180, 210A
	Richardson	5099-525	1/2" Valve Adapter O-ring		Diaclear	DP-46350	Slide Valve Cover O-ring
	Speck	2920241220	Model 440 Union O-ring		Starbright	--	Skim Filter Manifold O-ring
O-2153	Jacuzzi	47-0106-08	CFR Vent O-ring	O-2181	Jacuzzi	47-0380-47	CFT Cover O-ring
	K-D Pools	47-0106-08	Cartridge Filter O-ring		Jacuzzi	47-0386-62	Fat Boy O-ring
O-2155	Baker Hyd	254760	Old Style Spa Pak Pump O-ring		K-D Pools	47-0380-47	Cartridge Filter O-ring
	Hayward	SPX0722G	Ball Valve End Connector O-ring	O-2185	Hayward	SPX1905E	Self Drain Pump Housing O-ring
	Jandy	3381	Space Saver Valve O-ring	O-2186	Hayward	DEX0360E	Bulkhead Fitting O-ring
	King	106-100-008	Cam O-ring	O-2187	Premier	31-161	200 Series MK2 Volute O-ring
	King	746	Cam O-ring	O-2188	Anthony	17786	Plastic Valve Plunger Rod O-ring
	Lasco	--	2" PVC Union O-ring		Anthony	17792	2" Brass Push-Pull Valve O-ring
	Marlow	--	Mardur Pump Diffuser O-ring		Baker Hyd	00B7014	Valve Piston O-ring (For Kit Order 3)
	Purex	--	CHD 2" O-ring		Harmsco	551	Standpipe O-ring
	Purex	70345	O-ring		Hayward	GMX0142Z2	Pump O-ring
	Purex	71432	2" Valve Cap O-ring		Purex	70212	OOB7014 Valve Piston O-ring
O-2159	American	192320	Clean & Clear Plus Upper Bulkhead O-ring		Speck	2920141250	Casing O-ring Model 420
	Sta Rite	U9-203	Sand Filter O-ring		Sta Rite	--	Valve Piston O-ring
	Waterway	805-0145	2" Heater Tailpiece O-ring		Sta Rite	35505-0314	Q30 MK O-ring
O-2160	American	469150	Standard Air Control O-ring		Sta Rite	35515-0314	Q30 MK Adapter O-ring
	Hayward	SPX0712	Vari Flo Pipe Socket O-ring	O-2189	Acura	1660	Pump Union O-ring
O-2164	Hayward	GMX0400F	Valve to Tank Lid O-ring		American	501521	1 1/2" Multiport II Valve O-ring
O-2165	Amer Gran	55-1150B55	2" Heat Sink O-ring		American	510058	Standpipe O-ring
	American	391028	Swivel Union O-ring		Aqua Flo	92200110	FM Series Suction O-ring
	American	467170	Diverta Port Valve Cap O-ring		Aqua Flo	FF-12-1	O-ring
	Baker Hyd	30C3119	2" Valve Plug O-ring		Caretaker	1132	Small O-ring
	Caretaker	413-0501	Mounting Bracket O-ring		Harmsco	784	2 1/8" O-ring
	Harmsco	783	2 1/2" O-ring		Lasco	--	1 1/2" PVC Union O-ring
	Hayward	SX0200Z4	S-160 & S-240 Sand Filter O-ring		Magic Vlv.	0301-226	1 1/2" Union O-ring
	Hydro Air	11-3449	Union O-ring		Marine	1560	Deck Filter Manifold O-ring
	Hyprime	--	Pot to Volute O-ring		Marlow	40478	Gemini O-ring
	Jacuzzi	17-0228-68	Union O-ring		Pentair/PF	15-5064	Tagelus Stand Pipe O-ring
	Jacuzzi	47-0222-68	Splash Pak O-ring		Pentair/PF	15-5564	Star O-ring
	Jacuzzi	47-0228-01	Jet Charger 225 A, B, C O-ring		Premier	33-229	O-ring Set For Pump (O-2189 & O-2226 Make Set)
	Jacuzzi	47-0228-35	Gyromat B/W Upper Valve O-ring		Premier	P-NPS	Small Pump Volute O-ring-Noryl
	Jacuzzi	47-0228-68	Union O-ring		Purex	71424	Cap O-ring
	Purex	--	N/S Tahitian Adapter O-ring		Purex	71440	Coupling O-ring
	Purex	71426	Collar & Rotor O-ring		Sta Rite	35505-1238	FCP Cartridge Drain Plug O-ring
	Sta Rite	--	Float Valve O-ring		Sta Rite	U9-269	Cartridge Filter Drain Plug O-ring
	Sta Rite	U9-205	Sand Filter Riser Tube O-ring	O-2195	American	390040	Diffuser O-ring For Power Pump
O-2167	Caretaker	634002	Hydrostorm Pot Lid O-ring		American	468240	Power Glass Slip Body O-ring
	Marlow	44308	Argonaut Cover O-ring		Aqua Flo	--	Male Adapter O-ring
	Martec	320-102	Trap Lid O-ring		Aqua Flo	92200140	O-ring
	Premier	33-487	Clear Lid O-ring		Aqua Flo	FF-17-03	O-ring
	Premier	33-489	6" Cover O-ring		Aquatherm	17-051-003	O-ring
	Sta Rite	U9-046	6" Pump Lid O-ring		Baker Hyd	30C3018	TM 1 1/2" Center Tube O-ring
	Waterco	63151	Supatuf Pump H/L Pot O-ring		Baker Hyd	30C3019	1 1/2" Valve Plug O-ring
O-2170	Diaclear	8256-11	ES-7 Gorman Rupp O-ring		Grid	--	O-ring for 3050, 3051, 3052
	Doughboy	308-1010	Pump O-ring		Hayward	SPX1425Z6	EC-65 Inlet Fitting O-ring
O-2172	Jacuzzi	47-0433-02	Filtromat O-ring		Hayward	SPX1485B6	Union Elbow O-ring
	Pentair/PF	35-2600	New Style 700 Pump Lid O-ring, P Series Lid O-ring		Hydro Air	10-5857	O-ring
	Pentair/PF	35-5332	Old Style Challenger Pump Lid O-ring		Hydro Air	11-3429	O-ring
	Sta Rite	--	XLVII H & L Pot O-ring		Hyprime	--	Impeller O-ring
	Sta Rite	XL-VII	H&L Pot O-ring		Jacuzzi	47-0226-03	Inlet Fitting Seal O-ring
O-2175	American	510162	Directional Valve 2 & 3 Port O-ring		Martec	410-511	Bathmaster Jet Body O-ring
	Compool	OR-6	Cover O-ring		Martec	700-103	Union O-ring
	Grid	3009	Cover O-ring		Pentair/PF	35-4571	Dynamo Adapter O-ring
	Jandy	1132	Vinyl Cover O-ring		Premier	21-502	1 1/2" Cap O-ring
	Polaris	E-30	Backup Valve Case O-ring		Premier	29-674	1 1/2" Tailpiece O-ring
	Polaris	E-31	Backup Valve O-ring-1986-91				

O-RINGS-LISTED IN SSC# ORDER

SSC#	FITS OEM	FITS OEM#	DESCRIPTION	SSC#	FITS OEM	FITS OEM#	DESCRIPTION
	Sta Rite	U9-226	Duraglass Diffuser, Quantum Spa, Cart.O-ring	O-2215	Cal Pump	11190	Volute O-ring-5580, 900, 1220-S
	Sta Rite	WC20-24	Pump O-ring		Pentair/PF	19-2320	Stainless Steel DE Filter O-ring, Bulkhead O-ring
	Vico	UPULO/R2	Ultra Flow 2" Union O-ring		Waterway	805-0145	2" Union Connector O-ring
	Waterway	805-0226	Union O-ring	O-2216	Doughboy	308-1014	1141 & 1162 MY185RP Cartridge O-ring
	Waterway	805-0226	1 1/2" Union Tailpiece O-ring		Purex	71445	Whisperflo Seal Plate O-ring
O-2199	WMC	JS-1505R	Union O-ring	O-2217	A&A Mfg.	820-115	Water Valve O-ring
	Hayward	DEX0360M	Bulkhead Fitting O-ring		Airquatic	5099-149	FG Filter Lid O-ring
	Jacuzzi	47-0142-04	2" Valve O-ring		Pentair/PF	15-2501	Valve Adapter O-ring-TA100D
O-2200	Doughboy	308-1174	4 Position Valve Stem O-ring		Sta Rite	U9-241	Pump O-ring
	Harmsco	552	Holding Rod O-ring	O-2218	American	391019	Maxim, Americana II Lid O-ring
	Pentair/PF	17-5680	Drain Port O-ring		Anthony	04387	AC2, AS2 5" Strainer Cover O-ring
	Speck	2991300005	Badustar 913 Cartridge O-ring		Anthony	U9-161	Centrifugal Pump Trap Cover O-ring
O-2201	Diaclear	C-10146	MS-12 to MS-18 O-ring For C10145		H & F	--	Pump O-ring
	Anthony	--	New Style Piston O-ring		Landon	--	Pump Lid O-ring
O-2203	Coleco	33236	Strainer Inlet O-ring		Lomart	--	Pump Lid O-ring
	Doughboy	308-1061	Dynaflow Basket Port O-ring		Luitweiler	--	Pump O-ring
	Jacuzzi	47-0218-11	Air Control O-ring		Sta Rite	U9-161	5" Pump Trap Lid O-ring
	Jacuzzi	47-0218-45	Air Control O-ring	O-2219	Swimrite	60-828-715	5" Pump Lid O-ring
	Plastiline	--	3/4 Union O-ring		Jacuzzi	47-0240-05	O-ring
O-2205	Blue White	9003-020	Chlorinator O-ring		Pentair/PF	19-5007	4" Diameter Adapter O-ring
	Doughboy	308-1013	Pump Discharge O-ring	O-2220	Arneson	E-43	Turbo Sweep Seal Plate O-ring
	Fischer	101W910U01	Chlorinator O-ring		Astral	721R0195030	Light O-ring
	Jacuzzi	47-0022-09	Shaft Sleeve O-ring		Blue White	9003-067	Chlorinator O-ring
O-2208	American	468155	Aqua Lumin Light O-ring		Compool	OR-4	Shaft O-ring
	American	510059	Air Relief Valve Sep. Tank O-ring		Doughboy	308-1054	Drain Valve O-ring
	Arneson	G-12	Gear Housing O-ring		Jacuzzi	47-0016-05	1 1/2" Valve O-ring
	Blue White	9003-003	Chlorinator O-ring		Jacuzzi	47-0016-06	Filtromat Cover O-ring
	Hayward	SPX0072Z4	Sight Glass O-ring		Jacuzzi	47-0116-05	Valve O-ring
	Laars	S-328	Heater O-ring		Jacuzzi	47-0116-30	Dial Valve O-ring
	Letro	LG-12	O-ring		Jacuzzi	47-0117-05	Shaft O-ring
	Olympic	ACM94-7	Chlorine Feeder Valve O-ring		Jandy	1307	Shaft O-ring
	Purex	71419	Whisperflow Lock Screw O-ring		Letro	LE-43	Turbo Sweep O-ring
	Purex	75713	Whisperflo O-ring		Martec	201-002	Bleed Plug O-ring
	Sta Rite	35575-1114	Shaft O-ring-MK37, 47, 57 Series		Pentair/PF	--	Crankshaft O-ring
O-2209	Acura	1061	Magna Faceplate O-ring		Pentair/PF	02-116	Crankshaft O-ring
	Doughboy	308-1124	Cyclops Mark 5 O-ring		Pentair/PF	19-2039	SCS Spin Filter Crank O-ring
	Hayward	SPX1580Z1	Powerflo Housing O-ring		PoolswEEP	E-43	Turbo Sweep O-ring
	Jacuzzi	47-0258-04	O-ring		Purex	71428	Tahitian Cap & Rotor Shaft O-ring
	King	942	King Tech Body Cap O-ring-Perform.		Purex	72552	Shaft Liftlock O-ring
	Lomart	053-132	Cyclops Mark 5 O-ring	O-2221	Speck	2920141230	Filter Plug O-ring
	Polaris	P-95	Volute O-ring		Aqua Flo	92200160	O-ring
	Premier	35-162	Volute O-ring		Hayward	--	Center Rod O-ring
	Purex	71417	AT Series Pump B/V O-ring		Jacuzzi	47-0213-08	S/W Injection Plug O-ring
	Purex	71427	Aquatron Pump B/V O-ring		Purex	71434	Noryl Rotor Shaft O-ring
	Sta Rite	35505-1275	Cover O-ring For M/V WC112-147		Speck	2923441200	Model 21-80 O-ring
O-2210	Vico	PPBFV/OR	Big Foot Pump O-ring	O-2222	American	--	Air Relief Valve O-ring
	Wallace	44121	Chlorinator O-ring		American	--	Air Relief Valve O-ring
O-2211	American	501517	Lid O-ring		Blue White	C-350	Check Ball O-ring
	Aqua Flo	92200220	Trap Lid O-ring		Jacuzzi	47-0008-07	CFR Air Vent O-ring (Prior 1/88)
	Jacuzzi	47-0254-08	Flo Pro O-ring		Jacuzzi	47-0080-76	O-ring
	Praher	T15-E3	Cover O-ring		Marine	166-6	Thermometer O-ring
	Sta Rite	--	Dial Valve O-ring		Sta Rite	35505-1009	Hydro-Valet Face Plate Inlet O-ring
	Sta Rite	14962-35	Large O-ring For Kit	O-2223	American	570078	Commander Center Rod O-ring
	Waterway	805-0254	Top Mount Valve Lid O-ring		Baker Hyd	--	Newport Valve Shaft O-ring
O-2212	Doughboy	308-1012	#1110D Tank O-ring		Hayward	--	Cartridge Filter Center Rod O-ring
	Jacuzzi	47-0161-00	DA1A-DA1B Case O-ring		Hayward	CX0250Z6	O-ring
	Vico	PPSFV/OR	Super Flo Pump O-ring		Laars	E-363	Heater O-ring
O-2214	Anthony	04412	AR Seal Plate O-ring				
	Anthony	U9-169	Seal Plate O-ring				
	Jandy	R0340400	Medium Head Body O-ring				
	King	01-22-9426	Body O-ring ('91 & Prior)				
	Pentair/PF	35-4535	Dynamo Bracket Diffuser O-r				
	Waterco	635028	Supatuf Pump Body O-ring				

O-RINGS-LISTED IN SSC# ORDER

SSC#	FITS OEM	FITS OEM#	DESCRIPTION	SSC#	FITS OEM	FITS OEM#	DESCRIPTION
	Poolco	1XL FP	Air Relief Plug O-ring for Cartridge Filter	O-2234	Jacuzzi	47-0144-02	2" Multiport Valve O-ring (Prior to 8/73)
O-2224	Purex	71449	Tahitian Filter Shaft O-ring		Purex	74021	CFM Manifold O-ring
	American	510119	Standpipe O-ring	O-2236	Jacuzzi	47-0355-06	1 1/2" Sandtrap Filter Lid O-ring
	American	850151	S-20 Skimmer Bottom O-ring		Jacuzzi	47-0355-48	PH Series Cover O-ring
	Astral	690R0406	Sand Filter O-ring	O-2239	American	550067	Sahara Drain Filter O-ring
	Astral	710R0402	O-ring		American	570068	Eclipse O-ring
	Caretaker	413-0620	Lid O-ring		Astral	722R0198035	O-ring
	Jacuzzi	47-0358-03	Magnum Pump O-ring (After 7/89)		Astral	722R0198036	Multiport Valve Rotor Axle O-ring
	Jacuzzi	47-0359-02	PM Filter Valve O-ring		Electrofeed	--	25 A Fitting O-ring
	Jandy	R0338900	Pot Lid O-ring		Hayward	CX0900H	Star Clear Plus O-ring
	King	01-22-9926	Cap O-ring (Current)		Hustler	A211	Large O-ring
	King	992	400/430, 940 Cap O-ring		Sta Rite	35505-1223	2" Valve Stem O-ring
	Pentair/PF	35-3525	Old Style Porpoise Filter Clear Lid O-ring	O-2240	Anthony	--	4" Pump Lid O-ring
O-2226	Acura	1062	Magnaflow 2" Union O-ring		Doughboy	308-1004	H&L Pot O-ring
	American	570082	Admiral Twin Port Skimmer S20 Equalizer		Jacuzzi	47-0347-07	Gyromat O-ring
	Aqua Flo	92200100	FM, B Series Suction O-ring		Pentair/PF	HL4	4" H&L Trap O-ring
	Aqua Flo	FF-12	O-ring		Purex	--	Eastside 4" H&L Trap O-ring
	Astral	7730599035	Astra Max O-ring	O-2242	Sta Rite	--	4" Old Style Pump Lid O-ring
	C & R	20-2056	2" Union O-ring		Hayward	SPX0733Z1A	Valve Key O-ring
	Doughboy	308-1008	Valve Body O-ring		Jacuzzi	47-0118-04	S/W Injectors O-ring
	Hydro Air	11-3469	O-ring		Letro	LLU6	Feedmast O-ring
	Jacuzzi	47-0229-00	O-ring		Letro	LLU7	Feed Mast O-ring
	Jacuzzi	47-0467-01	Dial Valve O-ring		Martec	400-108	Reed Valve O-ring
	Martec	700-203	Sonfarrel 2" Union O-ring		Muskin	54078	Small O-ring
	Martec	700-308	2" Tailpiece O-ring		Waterco	621462	Gray Valve Sight Glass O-ring
	Pentair/PF	35-5330	Challenger Pump Strainer Pot Flange O-ring		WMC	62133	Hydro Sand Filter Sight Glass O-ring
	Premier	--	Large & Spa II O-ring		WMC	621462	Hydro Sand Filter Sight Glass O-ring
	Premier	25-229	2" Tailpiece O-ring	O-2243	Arneson	K-965	Body O-ring
	Premier	P-NPL	Large Noryl Pump Volute O-ring		Hayward	SPX0727K	Valve O-ring
	Regal	S-409	Chlorinator O-ring		Hayward	SPX0728H	End Connector O-ring
	Sundance	6560-044	Hi-Flo Heater Union Fitting O-ring		King	106-100-019	Basket O-ring
	Waterway	805-0229	2" Heater Tailpiece O-ring		King	722	Basket O-ring
O-2227	American	469115	Air Control O-ring		Purex	72557	Ortega Valve Equalizer O-ring
	Blue White	9003-051	Chlorinator O-ring	O-2247	Purex	P-26136	Ortega Equalizer O-ring
O-2228	Aqua Flo	92200000	A Series 5" Trap Cover O-ring		Anthony	HL6	6" Pump Lid O-ring
	Aqua Flo	AF-10	5" Lid O-ring		Aqua Flo	92200010	A & AC Series 6" Trap Cover O-ring
	Bio Lab	25475HYD	Brominator Lid O-ring		Aqua Flo	AF-10-01	O-ring
	Bio Lab	B-94	Brominator Lid O-ring		Hayward	SPX3000S	SP3000 Pump Lid O-ring
	Guardex	25475HYD	Brominator Lid O-ring		Hydropump	--	6" H & L Trap O-ring
	Guardex	B-94	Brominator Lid O-ring		Jacuzzi	47-0438-07	Cast Iron Pump Lid O-ring
	Hydrotech	25475HYD	Brominator Lid O-ring		Leslies	SPX3000-S	Hydramax II Cover O-ring
	Hydrotech	B94	Brominator Lid O-ring		Pentair/PF	HL6	Hydro 6" H&L Trap O-ring
	Marine	--	5" Clear Lid O-ring		Purex	--	Eastside 6" H&L Trap O-ring
	Premier	31-486	5" Cover O-ring		Purex	71421	PJ-18 Pump Lid O-ring
	Sta Rite	--	5" Clear Lid O-ring		Sta Rite	--	Old Style 6" Lid O-ring
	Sta Rite	35505-1344	O-ring		Sta Rite	U9-375	Maxi Glass II Trap O-ring
	Swimrite	--	5" Clear Lid O-ring		Sta Rite	U9-399	Maxi Glass Trap O-ring
O-2231	American	850057	Manifold O-ring		Wet Inst.	34-050-303	Pump O-ring
	American	862005	Manifold O-ring	O-2248	Ampro	--	900-9S Small Spool O-ring
	Anthony	17681	3/16" Piston & 2" Cap O-ring		Blue White	9003-011	Chlorinator O-ring
	Doughboy	308-1046	O-ring		Blue White	C-502	Tube Adapter O-ring
	Hayward	SPX1483C	Valve Union O-ring		Hayward	GMX0400P	Flange Mount Valve Stem O-ring
	Jacuzzi	47-0223-06	Filter Valve O-ring		Hayward	GMX0600P	GM-600 Valve O-ring
	Kreepy	12-800	Swivel Housing O-ring		Jacuzzi	47-0013-00	Drain Plug O-ring
	Monarch	--	New Style Impeller O-ring	O-2249	American	392014	Lid O-ring
	Paddock	--	Star Clear Tube & Manifold O-ring		Nature 2	2-13073	Cap O-ring
	Purex	71431	800 Series Manifold O-ring		Premier	--	550 6" Lid O-ring
	Saurerman	--	Backwash Valve Valve O-ring		Premier	P-13-6P	Clear Lid O-ring
	Sta Rite	35505-1236	Sil. Seal & Capri Return O-ring		Purex	71423	Flange O-ring
	Sta Rite	35505-1429	Elbow Assembly O-ring		Speck	2920741210	Model 423 Lid O-ring
	Sta Rite	U9-199	Diffuser O-ring	O-2252	Acura	1060	Maverick Pump Face Plate O-ring
					Aqua Flo	92200150	Volute O-ring

O-RINGS-LISTED IN SSC# ORDER

SSC#	FITS OEM	FITS OEM#	DESCRIPTION	SSC#	FITS OEM	FITS OEM#	DESCRIPTION
	Aqua Flo	92200270	FMCP Volute O-ring		PoolswEEP	G-32	O-ring
	Hayward	SPX1082Z5B	Powerflo Volute O-ring (Before 1986)	O-2264	Waterway	805-0123	Tailpiece Union O-ring
	Jacuzzi	47-0251-01	Press Molder Lint Catcher O-ring		American	--	Americana Spacemaker O-ring
	Martec	310-104	Booster Pump O-ring		Coleco	31954	Top O-ring
	Sta Rite	--	XL-VII Bracket to Volute O-ring		Doughboy	308-1062	Cartridge Filter Coupling O-ring
	Sta Rite	U9-114	Pump O-ring		Jacuzzi	47-0123-07	RM2 Injector Cap O-ring (As of 11/91)
	Sta Rite	U9-167	Pump O-ring		Jacuzzi	47-0212-66	O-ring
O-2253	American	792005	O-ring		Jacuzzi	47-0214-07	Valve Stem O-ring
	Aqua Flo	92200120	Pipe Plug O-ring		Marine	1150	Locknut O-ring
	Hayward	DEX2400Z3A	Micro Clear DE O-ring		Pentair/PF	19-2040	Crank Cap O-ring
	Letro	LA-375	Booster Pump Drain Plug O-ring		Rainbow	17-2451	Check Valve O-ring
	Pentair/PF	27-2707	1 1/4" Hi Flow Valve Knob O-ring		Swimrite	28-828-681	Marathon Grid O-ring
O-2254	Arneson	K-966	Element O-ring		Waterco	621457	Gray Valve Shaft O-ring
	Astral	00091R0204	O-ring		WMC	621457	Hydron Sand Filter Axle O-ring
	International	--	Collection Tube O-ring	O-2266	Astral	773R1450050	Sand Filter O-ring
	Jacuzzi	47-0028-03	Filter Valve O-ring		Coleco	33221	Pump O-ring
	Sta Rite	35505-0239	Skimmaster Tube O-ring		Gulf	352501903	Power Tech 2 Lid O-ring
O-2255	Doughboy	308-1002	Lid Bushing O-ring		Hayward	SPX0714L	Cover O-ring for Variflo XL Valve
	International	--	Lower Piston O-ring		Jacuzzi	47-0357-04	Pump Lid O-ring
	Jacuzzi	47-0216-05	Verturi O-ring		Jacuzzi	47-0357-46	JC Pump Housing O-ring
	Sta Rite	14962-35	Small O-ring For Kit		Jacuzzi	47-0433-51	USLB 6" Lid O-ring
	Sta Rite	35505-1228	Dial Valve O-ring		K-D Pools	47-0357-46	K Square Ring
	Swimrite	--	Old Style Lower Piston O-ring		Muskin	72198	Valve Top O-ring
O-2256	Advance	OV-11-212	Chlorinator O-ring		Pentair/PF	35-4053	700 Glass Pump Lid O-ring
	American	501414	1 1/2" Multiport Valve T/M Series O-ring		Sta Rite	35505-1402	O-ring
	American	501519	Rotor O-ring		Sta Rite	35505-1438	ABG Pump Seal Plate O-ring
	American	510026	Valve O-ring		Sta Rite	U9-211	Sand Filter Cover O-ring
	American	510177	2" Valve Stem O-ring		Sta Rite	U9-357	Dura Jet Seal Plate O-ring
	American	982207	2" P Valve Shaft O-ring		WMC	62100	Hydron Sand Filter Neck O-ring
	Baker Hyd	30C3009	1 1/2" Multiport Valve Shaft O-ring	O-2270	Aqua Flo	92200210	O-ring
	Baker Hyd	30C3109	2" Multiport Valve Shaft O-ring		Conger	--	O-ring-2 3/4" OD x 1/8" TH
	Conger	--	O-ring- 1 1/8" OD x 1/8" TH		Hayward	SX0200Z3	Filter O-ring
	Hayward	SPX0735G	Valve Stem O-ring		Magic Vlv.	0301-227	2" Union O-ring
	Jacuzzi	47-0212-09	RM2, 3 S/W Injector O-ring		Monarch	--	Pump to Volute O-ring
	Jacuzzi	47-0465-03	Diverter Dial Valve O-ring		Purex	72560	2" Ortega Valve Cap O-ring
	Muskin	54067	FP Parker Pump O-ring	O-2271	Sta Rite	U9-265	C Series Shaft O-ring
	Pentair/PF	--	Multiport Valve Shaft Seal O-ring	O-2272	Jacuzzi	47-0348-06	Multiuse Pump & Filter O-ring
	Pentair/PF	19-1479	Star DE Filter Shaft O-ring	O-2278	Jacuzzi	47-0370-07	2" Multiport Valve O-ring
	Pentair/PF	27-1162	Valve Stem O-ring		Richardson	5099-149	Sand Lid O-ring
	Wallace	46129	Chlorinator O-ring	O-2280	Hayward	SPX0735H	Ball Valve Connector O-ring
O-2257	Blue White	9003-016	Chlorinator O-ring		Sta Rite	--	Index Plate Large O-ring
	Jacuzzi	47-0020-01	K Series Filtromat O-ring		Sta Rite	--	Plastic Slide Valve Cap O-ring
O-2259	Jacuzzi	--	Plastic Multiport Stem O-ring		Sta Rite	35505-1246	Turbo Clean Head O-ring
	Regal	S-405	Chlorinator O-ring		Waterway	805-0232	2 1/2" Union O-ring
	Sta Rite	U9-370	Lateral O-ring	O-2281	Blue White	9003-024	Chlorinator O-ring
O-2261	Hayward	SPX0605Z2	Stem O-ring	O-2282	Anthony	--	Old Style Light Base O-ring
	Hayward	SX0200Z14	1980 O-ring		Caretaker	1133	Union O-ring
	Marine	--	Old Style Crank O-ring		Hayward	SPX1500N	O-ring
	Muskin	19-2115	Drain Plug O-ring		Hayward	SX0220Z3	Pro Filter O-ring
	Pentair/PF	17-5687	Air Relief Valve O-ring		Omni	0-5960	Chlorinator O-ring
	Pentair/PF	27-2511	1 1/2" Hi Flow Shaft O-ring		Pentair/PF	--	Nautlius Lower Pipe Assembly O-ring
	Sta Rite	77707-0117	Pool Heater O-ring (for kit order 6)		Pentair/PF	15-4492	2" Bulkhead O-ring
O-2262	American	421612	Power Glass Volute O-ring		Plastiline	--	2" Union O-ring
	Aqua Flo	92200090	FMH Series Volute O-ring		Purex	B-94	Regular Lid O-ring
	Aqua Flo	FF-11	O-ring		Sta Rite	--	HRV 24 O-ring
	Brett	100022K	EM203 Pump O-ring	O-2283	Sta Rite	WC9-007	Sand Filter O-ring
	Diaclear	C-10139	MS-16 & MS-18 Cover O-ring		Laars	S-735	O-ring
	Pentair/PF	35-2626	Backwash Valve O-ring/Volute O-ring	O-2286	Pentair/PF	15-4004	Triton C-3 Filter O-ring
	Premier	31-158	Volute O-ring		Doughboy	308-1052	Strainer Body O-ring-1984
O-2263	Arneson	G-32	Lower Bearing O-ring		Doughboy	308-1067	Power Pak 2 Lid O-ring
	Letro	LG-32	O-ring		Doughboy	308-1167	Power Pak 2 Lid O-ring
					Hayward	SPX5500H	Lid to Housing O-ring for Powerflow Matrix A/G Pump

O-RINGS-LISTED IN SSC# ORDER

SSC#	FITS OEM	FITS OEM#	DESCRIPTION	SSC#	FITS OEM	FITS OEM#	DESCRIPTION
	Pentair/PF	35-4634	Bracket Diffuser O-ring-After 12/93	O-2374	American	271151	2" P Valve Lid O-ring
O-2287	Polaris	9-100-5108	Hose Nut, Cuffless Hose O-ring	American	510023		O-ring
O-2288	Jacuzzi	47-0021-00	Air Control Valve Seat O-ring	Baker Hyd	30C3105		2" Multiport Valve Cover O-ring
O-2292	Olympic	ACM-94-5	Chlorinator Cover O-ring	Jacuzzi	47-6172-04		Top O-ring for Sandstorm 31 Filter
	Pentair/PF	27-2541	Valve Body O-ring TA30/35/40/50/60	Pentair/PF	27-1151		Cover O-ring
O-2293	Jacuzzi	47-0443-00	Sandtrap Filter V/A O-ring	Waterway	805-0261		Executive 56 Pump Volute O-ring
	Speck	2920941210	Lid O-ring	O-2375	American	873004	Predator Body O-ring
O-2294	Martec	205-106	Filter Head O-ring	O-2376	Pentair/PF	15-4693	Knob O-ring
	Pentair/PF	35-5619	Pinnacle Seal Bracket O-ring	O-2377	Waterway	--	Housing O-ring for Diverter Gate Valve
	Poolco	65CW FHOR	Filter Head O-ring	O-2378	American	501523	Meteor Hose Assembly O-ring, Sight Glass O-ring
O-2295	Jacuzzi	47-0165-06	D83 Case O-ring For DB1 Pump	Lasco	--		Old Style O-ring for 1 1/2" Sch. 80 Union
O-2297	American	510167	Multiport Valve 2" Lid O-ring	O-2379	Lasco	--	Union O-ring
	Sta Rite	35505-1412	Lid O-ring Multiport Valve Side Mount O-ring	O-2381	Nature 2	2-13035	Model G Purifier Inlet O-ring
	Sta Rite	35505-1421	Lid O-ring For 2" Side Mount Valve	O-2386	Speck	2991500001	Bearing O-ring
O-2300	Arneson	W-542	Pool Vac O-ring	O-2387	Sta Rite	35505-1426	Impeller Screw O-ring
	Jacuzzi	47-0361-08	RP3 Case O-ring	O-2387	Jacuzzi	47-0371-06	CE Body O-ring
	Jacuzzi	47-0361-48	Cygnets O-ring	Pentair/PF	07-5846		Commercial R Seal Plate O-ring
O-2301	Acura	1081	Aquaheat Diffuser O-ring	O-2388	Waterway	805-0383	Clearwater DE, Cartridge Top O-ring
O-2302	Pentair/PF	27-3512	Nautilus Air Bleeder O-ring	O-2389	Pentair/PF	07-5847	Commercial R Lid O-ring
	Pentair/PF	27-3513	Air Bleeder Screw O-ring	O-2390	Jandy	R0353400	CT Series Cartridge Filter Lid O-ring
O-2303	Pentair/PF	27-3514	Stainless Steel Sand Filter O-ring	O-2391	Muskin	72209	Filter Head Cover O-ring
O-2304	Speck	2920341220	Model 400 2 Bolt O-ring	O-2392	Pentair/PF	17-8568	DM Tank/Cartridge O-ring
	Speck	2920841210	433T Lid O-ring	O-2393	Raypak	06713F	O-ring
	Speck	2921141210	90 Lid O-ring	O-2395	Hayward	CCX1000G	Body O-ring for Xstream Cartridge Filters
O-2305	Speck	2920341225	Model 400 4 Bolt O-ring	O-2401	Doughboy	308-1018	Manifold Quad Ring
	Sta Rite	U9-373	Dynaglass Seal Plate O-ring	O-2402	American	530018	Female Bell Quad Ring
O-2306	Hayward	CX0900F	Filter Head O-ring	Marine	1350		990MS & BH Filter Quad Ring
	Premier	31-418	Renegade 725 O-ring	O-2403	Sta Rite	35515-1296	Valve Connector Quad Ring
	Premier	31-420	Renegade Volute O-ring	O-2404	American	395004	Seal Plate Quad Ring (Prior to 1975)
	Sta Rite	U9-228A	P2R Pump Housing O-ring	O-2405	Sta Rite	--	Spin Filter Tube Quad Ring
O-2307	Hayward	CX0400G	Cover O-ring	Sta Rite	Q4327		Manifold Quad Ring
	Hayward	SPX4000TS	Cover O-ring/Gasket for Northstar Pump	O-2406	Sta Rite	35505-0114	Crank Shaft Quad Ring
	Speck	2921141220	Model 90 Casing O-ring	Sta Rite	35515-0114		Crankshaft Quad Ring
O-2308	Speck	2920241210	O-ring	Sta Rite	Q4112		Large Crank Quad Ring
O-2309	Gulf	352501904	Power Tech 2 Knob O-ring	Starbright	--		Crank Quad Ring
	WMC	JS-1571	JS Pump Knob O-ring	O-2408	Pentair/PF	35-2602	Old Style RPZ 590 5" Pump Lid Quad Ring
O-2321	Hydro Air	10-027EP70	Butterfly Jet O-ring	O-2409	Pentair/PF	35-5030	MH Challenger Diffuser Quad Ring
O-2324	Cal	10240	Volute O-ring-A280, 320, 430-A	Sta Rite	35515-1297		CFP Cartridge Filter Valve Connector Quad Ring
O-2326	Rainbow	R37121	Concorde Plate O-ring	O-2410	American	510010	New Style Quad Ring
	Rainbow	R37009	Concorde Motor Housing O-ring	O-2411	Sta Rite	--	Upright Spin Crank Quad Ring
O-2329	Hayward	SPX0733Z2A	O-ring For Diverter Valve	O-2412	Sta Rite	35515-0317	Filter Collection Tube O-ring
	Polaris	6-412	Vac Sweep O-ring	O-2414	Muskin	--	4 Way Valve Seat Quad Ring
O-2332	Pentair/PF	27-5300	Full Flow Valve O-ring	O-2417	Marine	1340	990MS & BH Filter Quad Ring
O-2339	Hayward	SPX0733Z2A	O-ring for Dial-A-Flow Filter	O-2419	Sta Rite	35515-0318	Collection Tube Quad Ring
O-2341	Poolco	3XL SOR	Threaded Strainer 1 1/2" O-ring for Vortex Pump	Sta Rite	35515-0514		Collection Tube Quad Ring
O-2343	Misc	--	O-ring for Commercial Sand Filter	O-2420	Muskin	54040	5 Position Valve Quad Ring
O-2345	Speck	2921641210	E91 Pump Lid O-ring	O-2502	Advance	OV-11-012	Chlorinator Viton O-ring
O-2346	Hercules	755314	O-ring	Fischer	101W707U01		Chlorinator Viton O-ring
	Jacuzzi	47-0255-07	DVK-7 O-ring	Regal	S-403		Chlorinator Viton O-ring
	Muskin	275-0007	6 Position Valve Cover O-ring	Wallace	26482		Chlorinator Viton O-ring
O-2350	Poolco	9CP 111-01	End Cap O-ring for Filters	O-2503	Advance	OV-11-006	Chlorinator Viton O-ring
O-2355	Hayward	SPX4000Z1	Diffuser O-ring/Gasket for Northstar Pump	Fischer	101W701U01		Chlorinator Viton O-ring
	Hayward	SX0360Z1	O-ring	Regal	S-301		Chlorinator Viton O-ring
O-2365	Letro	LL-13	Housing Body O-ring	Wallace	24161		Chlorinator Viton O-ring
O-2369	Letro	JV-11	Jet Vac O-ring	O-2504	Hayward	CLX0110K	Chlorine Feeder Viton O-ring
O-2373	Jacuzzi	47-0175-04	SC Series Case O-ring	O-2505	Advance	OV-11-028	Chlorinator Viton O-ring
				Regal	S-411		Chlorinator Viton O-ring

O-RINGS-LISTED IN SSC# ORDER

SSC#	FITS OEM	FITS OEM#	DESCRIPTION
O-2506	Advance Fischer Regal Wallace	OV-11-011 101W706U01 S-402 26234	Chlorinator Viton O-ring Chlorinator Viton O-ring Chlorinator Viton O-ring Chlorinator Viton O-ring
O-2507	Advance Regal Wallace	OV-11-008 S-302 30343	Chlorinator Viton O-ring Chlorinator Viton O-ring Chlorinator Viton O-ring
O-2508	Advance Wallace	OV-11-110 31702	Chlorinator Viton O-ring Chlorinator Viton O-ring
O-2510	Fischer Wallace	101W904U01 31882	Chlorinator Viton O-ring Chlorinator Viton O-ring
O-2511	Hayward	CLX0200K	Chlorinator Viton O-ring
O-2512	Fischer Wallace	101W709U01 30066	Chlorinator Viton O-ring Chlorinator Viton O-ring
O-2514	Fischer	101W716U01	Chlorinator Viton O-ring
O-2515	Advance Fischer Hayward Wallace	OV-11-210 101W715U01 SPX0605Z2V 26822	Chlorinator Viton O-ring Chlorinator Viton O-ring Drain Plug O-ring-Viton Chlorinator Viton O-ring
O-2516	Advance King Regal	OV-11-203 943 S-412	Chlorinator Viton O-ring King Feeder Perfomax Drain Plug Viton O-ring Chlorinator Viton O-ring
O-2517	Fischer Wallace	101W902U01 39648	Chlorinator Viton O-ring Chlorinator Viton O-ring
O-2518	Hayward	SPX3000SV	Chlorinator Cover Viton O-ring
O-2519	Advance E-Z Chlor Fischer Wallace	OV-11-112 918 101W710U01 26345	Chlorinator Viton O-ring Flometer Viton O-ring Chlorinator Viton O-ring Chlorinator Viton O-ring
O-2520	Advance Fischer Regal Wallace Wallace Wallace	OV-11-009 101W704U01 S-401 33051 34497 44119	Chlorinator Viton O-ring Chlorinator Viton O-ring Chlorinator Viton O-ring Chlorinator Viton O-ring Chlorinator Viton O-ring Chlorinator Viton O-ring
O-2521	Advance Fischer Wallace Wallace	OV-11-010 101W705U01 25900 41106	Chlorinator Viton O-ring Chlorinator Viton O-ring Chlorinator Viton O-ring Chlorinator Viton O-ring
O-2522	Rainbow	17-2009	Chlorinator Lid Viton O-ring
O-2523	King King	01-22-1920 192	New Water Cap O-ring, B-192 Ser. 100/200 Cap O-rng New Water Cap Viton O-ring
O-2524	Bio Lab	PC25350	MA Chlorinator Cover Viton O-ring
O-2525	Waterway	805-237V	Clearwater Feeder Viton Lid O-ring
O-2526	Astral	713R1206053	Chlorinator O-ring-Viton
O-2527	Astral	713R1329045	Chlorinator O-ring-After 06/03-Viton
O-2528	Rainbow	17-2240	Chlorinator Lid O-ring for HC3340-Viton
O-2604	American Premier Purex	392014 -- 71423	Blue Teflon Coated Lid O-ring 550 Blue Teflon Coated 6" Lid O-ring Blue Teflon Coated Flange O-ring
O-2605	Muskin	037-3412	Blue Teflon Coated Strainer Pump Lid O-ring
O-2607	Fischer Wallace Wallace	101W718U01 44045 5745	Chlorinator Viton O-ring Chlorinator Viton O-ring Chlorinator Viton O-ring
O-2608	Fischer Wallace	101W918U01 40040	Chlorinator Viton O-ring Chlorinator Viton O-ring
O-2609	Fischer Wallace	101W901U01 38437	Chlorinator Viton O-ring Chlorinator Viton O-ring
O-2610	Fischer	101W920U01	Chlorinator Viton O-ring
O-2611	Wallace	26784	Chlorinator Viton O-ring
O-2612	Fischer	101W903U01	Chlorinator Viton O-ring

SSC#	FITS OEM	FITS OEM#	DESCRIPTION
O-2614	Fischer	101W721U07	Chlorinator Viton O-ring
O-2615	Fischer	101W905U01	Chlorinator Viton O-ring
O-2616	Wallace	45336	Chlorinator Viton O-ring
O-2618	Baker Hyd Gulf Hayward Hayward Leslies WMC	31B1107 352506104 SPX1600R SPX3500K SPX1600-R SS-1600-R	Spa Pak Pump Diffuser Gask Power Tech Diffuser Gasket Super Pump Diffuser Gasket Super Spa Pump DiffuserGsk Hydramax II Diffuser Gasket Diffuser Gasket-AT

O-RING CORD

Priced by the foot, O-ring cord is handy to have in case you have to make emergency O-rings in the field.



SSC#	DIAMETER	SSC#	DIAMETER
OC-7000	1/16"	OC-7006	5/16"
OC-7000A	3/32"	OC-7008	3/8"
OC-7001	1/8"	OC-7010	7/16"
OC-7001A	5/32"	OC-7012	1/2"
OC-7002	3/16"	OC-7014	.535"
OC-7004	1/4"	OC-7016	9/16"
OC-7005	9/32"		

O-RING PULLER TOOL

Save those fingers! This inexpensive tool makes O-ring removal fast and easy.



O-10950
O-RING PICK

SMALL SIZED O-RING BOX

This kit contains the 24 most popular small sized O-rings for the Pool & Spa industry (2 3/4" OD and less). Each O-ring is identified with the SSC part number. Reference your SSC catalog to see the multiple listings for each O-ring.

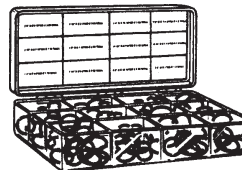

O-9000
SMALL SIZED O-RING BOX
24 different sizes. 10 of each size O-ring for a total of 240 O-rings in this kit..

PACKED IN A SHATTER PROOF
PLASTIC BOX WITH 24 COMPARTMENTS

LAMINATED O-RING SIZING GUIDE

Use this guide to identify any loose O-rings you have lying around. The guide is laminated for protection and all O-rings are shown life size with the SSC number clearly marked.

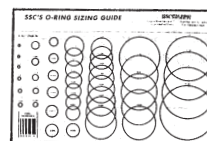

ORG-1
LAMINATED O-RING
SIZING GUIDE
8 Pages

GASKETS-LISTED IN SSC# ORDER

SSC#	FITS OEM	FITS OEM#	DESCRIPTION	SSC#	FITS OEM	FITS OEM#	DESCRIPTION
G-3001	Hayward	SPX1085D	Skimmer Gasket-Fiber	G-3111	Marlow	22991	Motor to Lantern Shim Gasket
	Jacuzzi	13-0010-03	Skimmer Gasket-Fiber	G-3112	Pentair/PF	35-3506	460-650 Pump Gasket
G-3002	Hayward	SPX1094G	Skimmer Gasket-Fiber	G-3114	Purex	--	Eastside Pump Gasket
	Rainbow	17-2471	DSF Skimmer Front Plate Gasket	G-3115	Sta Rite	--	VB35-1 Submersible Pump Gasket
G-3003	Hayward	SPX1097E	Skimmer Gasket-Fiber	G-3116	Peerless	--	4 Hole Bracket to Pot Gasket
G-3004	Muskin	54018	A-4372 & A-4372F Skimmer Gasket	G-3117	Pentair/PF	35-3502	540 Pump Gasket
	Muskin	A-4372	Skimmer Gasket	G-3118	Sears	--	Sprinkler Gasket
	Muskin	A-4372F	Skimmer Gasket		Sta Rite	C20-086	Sears Sprinkler Gasket
G-3006	Hayward	SPX1090E	Vinyl Skimmer Gasket-Fiber	G-3119	Sta Rite	--	D Series Pump Gasket
	Muskin	098-7235	Skimmer Gasket-Fiber	G-3120	Luitweiler	--	New Style Pump Gasket
G-3006K	Aqua Lead.	--	Skimmer Gasket Kit-2 Sets	G-3121	Pentair/PF	35-3513	880-881 Pot to Volute Gasket
	Olympic	ACM-83	Totaling 4 Gaskets	G-3122	Muskin	54012	5 Position Valve Gasket
	American	850077	Gasket Set	G-3123	Sta Rite	C20-087	Well & Irrigation Pump Gasket
G-3008	Pentair/PF	51-6231	W/T Skimmer Sealing Gasket	G-3124	Hayward	SPX1058D	Main Drain Gasket
	American	850034	Bermuda Skimmer Gasket	G-3125	Baker Hyd	35B1136	Spa Pak Pump Housing Gasket
G-3009	American	850034	Front Gasket For Front Access Skimmer		Hayward	SPX1500H	Pump Gasket-Fiber
G-3010	Baker Hyd	51B1047	Skimmer Face Ring Gasket (For Kit Order 2)	G-3126	Purex	--	Eastside Old Style 6 Hole Pot to Volute Gasket
G-3011	American	850033	Rear Gasket For Front Access Skimmer	G-3127	Hydropump	--	650 Pump Gasket
G-3012	Jacuzzi	13-0411-08	Face Plate Gasket For Wide Mouth Skimmer		Pentair/PF	--	Hydro 650 Model Pump Gasket
G-3014	Hayward	SPX1084B3	SP-1084-OM Gasket	G-3128	Hayward	SPX1250G	Pump & Mounting Bracket Gasket
G-3016	Hayward	SPX0084M	Skimmer Gasket	G-3129	Sta Rite	J20-009	Well & Irrigation Pump Gasket
G-3017	Hayward	CX25005B1	Gasket	G-3130	Purex	--	Eastside Old Style 8 Hole Pot to Volute Gasket
G-3018	Hayward	SPX0090E	Skimmer Gasket	G-3131	Hayward	SPX0058D	Main Drain Gasket
G-3019	Hayward	SPX0099E	Skimmer Gasket	G-3132	Hayward	SPX0505G	Shell Assembly Gasket
G-3020	Hayward	SPX1084B	Skimmer Gasket-Fiber	G-3133	Flint & Wall	--	Sprinkler Pump Gasket
	Pentair/PF	55-2566	Skimmer Gasket-Fiber	G-3134	Pentair/PF	--	Hydro VB-40 Volute Gasket
G-3021	Jacuzzi	13-0878-04	Flange Gasket	G-3135	Hydropump	--	560-700 Series Gasket
G-3022	Jacuzzi	94-1104-67	SV Basic Skimmer Face Gasket		Pentair/PF	--	Hydro 560-700 Series Gasket
	Muskin	54015	Skimmer Faceplate Gasket	G-3136	Flint & Wall	--	Pump Jet Gasket
G-3023	Sta Rite	C20-035	Delrin Plastic Volute Gasket		Sta Rite	J20-011	Well & Irrigation Pump Gasket
G-3024	Marlow	--	34 EC-15D Tank Cover Gasket	G-3137	Hayward	SPX1039C2	Fitting Gasket (For Kit Order 2)
G-3025	Laars	E-376	Heater Gasket	G-3138	Jacuzzi	13-0273-05	4 Way Valve Gasket
G-3026	Hayward	SPX1099E	1099 Skimmer Gasket-Fiber	G-3139	Anthony	--	Pump Gasket
	Jacuzzi	13-0462-06	SV, SL Skimmer Gasket		Purex	--	Eastside Old Style Volute Gasket
	Waterway	806-1070	Square Skimfilter Gasket	G-3140	Hydropump	--	Pump Sweep Motor Gasket
G-3027	Cascade	500010	Aqua Genie Faceplate Gasket-Fiber		Pentair/PF	--	Hydro Pump Sweep Motor Gasket
G-3028	Chemtech	27911	Series 200 Motor Housing Gasket	G-3141	American	453330	Pep Main Drain Gasket
G-3029	Waterway	806-1040	Skim Filter Gasket	G-3143	Lomart	043-013	Body Gasket
G-3030	Acura	0390	Power Quip Heater Gasket	G-3144	Ampro	--	Selector Valve Gasket-4 3/8" OD
G-3031	Sylvan	59200236	Old Style Vinyl Skimmer Gasket	G-3145	Muskin	54014	Discharge Fitting Gasket
G-3032	Sta Rite	U9-366	U3 Auto Skimmer Gasket	G-3146	American	792046	Spa Light Sealing Gasket (For Kit Order 3)
G-3034	American	850016	Liner Gasket-Fiber (For Kit Order 2)	G-3147	Purex	--	Eastside Seal Well Gasket
G-3035	Muskin	54024	Mini Skimmer Gasket	G-3148	American	510049	2" B/V Cap Gasket
G-3036	Rainbow	17-2470	DSF Skimmer Rear Gasket		Premier	21-391	2" Cap Gasket
G-3037	Equator	19-0159-2	Face Plate Gasket	G-3149	American	871020	Drain Pump Gasket
G-3038	Jacuzzi	13-0007-08	Standard Throat Gasket	G-3150	Muskin	54011	Self Priming Pump Housing Gasket
G-3039	Baker Hyd	51B1047	Hydro-Pak Face Ring Gasket	G-3151	Aqua Flo	91500000	AC Series Volute Gasket
G-3101	Luitweiler	--	Old Style Pump Gasket		Aqua Flo	ACF-11/915	Commercial Volute Gasket
G-3102	Luitweiler	--	Large 4 Hole Gasket		Sta Rite	C20-021	Pump Gasket
G-3103	Marlow	21034	Tank to Lantern Gasket	G-3152	Luitweiler	--	Small 4 Hole Gasket
G-3104	Monarch	--	Pump Gasket	G-3153	Jacuzzi	13-1223-04	Gasket
G-3105	Marlow	--	2112 8-Hole Large Cover Gasket	G-3154	Jacuzzi	13-0243-02	Gyromat Valve Gasket
G-3106	Marlow	--	34EC-15D Tank Gasket	G-3155	Pentair/PF	67-0018	Spa Vinyl Niche Gasket
G-3107	Pentair/PF	35-3501	Hydro B/V Pump Gasket	G-3157	American	792003	Niche Gasket (For Kit Order 2)
G-3108	Luitweiler	--	Pump Volute Gasket		Purex	71446	Old Style Vinyl Niche Gasket
G-3109	Pentair/PF	35-3514	880-881 Bracket to Volute Gasket	G-3158	American	792004	Standard Hole Niche Gasket (For Kit Order 3)-Fiber
G-3110	Pentair/PF	35-3515	Backwash Valve Pump Gasket	G-3159	Hydropump	VB40	Volute Gasket
				G-3160	Hydropump	VB2	Volute Gasket-200 Series VB2

GASKETS-LISTED IN SSC# ORDER

SSC#	FITS OEM	FITS OEM#	DESCRIPTION	SSC#	FITS OEM	FITS OEM#	DESCRIPTION
G-3161	Hydropump	400	Pot to Volute Gasket	G-3218	Gen. Major	--	Body Gasket
G-3162	Sta Rite	C20-009	Pump Gasket	G-3219	Hayward	SPX0125H	Pump Gasket
G-3163	Pentair/PF	63-4568	Vinyl Pool Niche Gasket	G-3220	Aqua Flo	91500100	A Series 3 HP Volute Gasket
G-3164	Sta Rite	C20-046	Pump Gasket		Aqua Flo	AF-11-01	3 HP Volute Gasket
G-3165	Hayward	SPX0506D	Niche Gasket		Premier	35-271	Bracket to Volute Gasket
G-3166	Hayward	SPX0125G	Pump Gasket		Premier	39-271	Bronze Pump Gasket
	Marlow	23112	H Series Pump Housing Gasket		Purex	72999	Guardex Washer-Fiber Pump Gasket
G-3168	Hayward	SPX0145G	Pump Gasket	G-3222	Sta Rite	VB43	Pump Gasket
G-3169	Anthony	VB27	Volute Pump Gasket	G-3224	Marlow	26588	Discharge Gasket
G-3170	Hayward	SPX1048D	Main Drain Vinyl Gasket-Fiber	G-3225	Muskin	038-3432	Viewport Gasket
G-3171	Jacuzzi	13-0463-05	SL Skimmer Suction Fitting Gasket	G-3226	Anthony	04465	AJ 105 Sweep Pump Gasket
					Sta Rite	C20-079	AJ Series Gasket
	Jacuzzi	13-0888-02	5-Way Valve Gasket	G-3228	Sta Rite	16800-11	Pump Gasket
G-3172	Jacuzzi	13-0192-03	Gasket		Sta Rite	16800-29	XLVI Old Style Gasket
G-3173	Hayward	SPX0409C2	Fitting Gasket (For Kit Order 2)	G-3229	Sta Rite	N20-039	Pump Gasket
G-3174	Marlow	--	34EC-15D Pump Inlet Gasket	G-3230	Muskin	54009	Viewport Gasket
G-3175	Purex	70952	Air Relief Fitting Gasket	G-3231	Muskin	101-6910	Vinyl Washer
G-3176	Jacuzzi	13-0191-04	Gasket	G-3232	Muskin	038-3439	Jet Stream Tank Gasket
G-3177	Pentair/PF	35-3500	Hydro Pot to Volute Gasket-Fiber	G-3233	Sta Rite	N20-025	Gasket
				G-3234	Pentair/PF	27-3004	Screw Type Valve Cap Gasket
G-3178	Hydropump	--	400 Pot to Volute Gasket	G-3235	Laars	--	Round By-Pass Gasket
	Pentair/PF	--	Hydro 400 Model Pot to Volute Gasket		Muskin	54007	Tank to Valve Inside Washer
G-3180	Lomart	042-024	Body Gasket	G-3236	Sta Rite	N20-026	Pump Gasket
G-3181	Martec	420-512	Eyeball Teflon Piece	G-3237	Arneson	G-29B	Gear Housing Gasket
G-3182	Jacuzzi	--	Filter Gasket	G-3238	Arneson	G-29	Gear Housing Gasket
G-3183	Rainbow	17-2541	Dynamic Lock Gasket	G-3239	American	570087	Olympian Filter Fiber Washer
G-3184	Chemtech	27903	Series 100/200 Gasket	G-3240	Aqua Flo	91500200	A Series 6" & 8" Trap Gasket
G-3185	Hayward	GMX0400D	GM-400 Multiport Gasket		Aqua Flo	AF-12-1	3 HP Trap Gasket
G-3186	Chemtech	42031	Series 200 Gasket-Fiber		Premier	32-248	Bronze Strainer to Volute Gasket
G-3187	Waterway	--	Large (Outside) Gasket For Jet on Medallion Pool		Premier	33-248	Pot to Volute Gasket
					Sta Rite	C20-019	Dura Glass Pump Gasket
G-3188	Waterway	--	Small (Inside) Gasket For Jet on Medallion Pool	G-3241	Pentair/PF	35-3512	880-881 Pot Flange Gasket
					Sta Rite	C20-103	Duraglass Pump Gasket-Fiber
G-3189	Ester Will.	--	Port Hole Gasket-Above Ground	G-3242	Hayward	SPX1023Z3	Inlet/Outlet Washer/Gasket-Fiber
G-3190	Muskin	54023	Thru Wall Return Gasket	G-3243	Purex	P-10675	VF30 Gasket
G-3191	Muskin	54020	Backwash Valve Cap & Pos. Valve Gasket	G-3245	Laars	E-325	Heater Gasket
G-3192	Muskin	54016	Backwash Valve Outside Tank Gasket	G-3246	Raypak	800004	1 1/2" Unitherm Governor Gasket
G-3193	Muskin	54005	FP Pump, Drain Fitting Gasket	G-3247	Purex	70941	Uniseal & L Series Bracket to Volute Pump Gasket
G-3194	Muskin	54006	Air Relief Bushing Gasket	G-3248	Purex	--	Eastside 2 Hole Pot to Volute Gasket
G-3195	Muskin	54021	Mylar Resin Tank Gasket	G-3249	H & F	--	Volute Gasket-Thin
G-3196	Muskin	54022	Resin Tank Gasket		Sta Rite	C20-072	Thin Pump Gasket
G-3197	Sta Rite	C20-101	CC Seal Gasket	G-3250	Ampro	6-146	Gasket
G-3198	Jacuzzi	13-0877-05	Gasket	G-3251	Aquarius	--	Volute Gasket
G-3199	Sta Rite	C20-100	CC Gasket	G-3252	Laars	E-516	Thermostat Cover Gasket
G-3202	Jacuzzi	13-0314-06	Pump Gasket-Fiber	G-3253	Anthony	04382	AC, AS Volute Gasket
G-3203	Ampro	646	Pump Gasket		Purex	P-10630	BT Series Backwash Valve Pump Gasket
G-3204	South Seas	--	Outlet Heater Gasket	G-3254	International	--	Bonnet Flange Gasket
G-3205	Diaclear	C-46251	MS 18 Pump Gasket	G-3255	Purex	70940	Pot to Volute L Series Pump Gasket
G-3206	Swimrite	36-828-266	Pool Control Gasket				
G-3207	H & F	--	Pot to Volute Gasket	G-3256	Aqua Flo	91500050	A Series 1/3 to 2 HP Volute Gasket, B Series Gask
	Hydropump	511	Pot to Volute Gasket VB20				
	Hydropump	VB20	511 Pot to Volute Gasket		Aqua Flo	AF-11	Volute Gasket
	Wet Inst.	34-050-309	Trap to Volute Gasket		H & F	--	Volute Gasket
G-3208	Sta Rite	G20-012	Well & Irrigation Pump Gasket		Premier	31-276	1/2-2 HP Volute Gasket
	Sta Rite	J20-012	Well & Irrigation Pump Gasket		Sta Rite	C20-072	Thick Pump Gasket
G-3209	Lomart	040-024	Body Gasket		Swimrite	60-828-276	Backwash Valve Pump Gasket
G-3210	Anthony	04466	Sweep Pump Gasket 105, VB44	G-3257	Peerless	--	Bracket to Pot Round Gasket
G-3211	Peerless	--	2 Hole Pot to Volute Gasket	G-3258	Sta Rite	C20-102	ACP Pump Seal Plate Gasket
G-3212	Doughboy	307-1004	Cartridge Gasket	G-3259	Sta Rite	CN20-035	Pump Gasket
G-3214	Filter Flow	--	Body Gasket		Sta Rite	N20-035	Pump Gasket
G-3215	Hayward	SPX0508BA	Cover Gasket Only	G-3261	Sta Rite	C20-077	C & CC Series Pump Gasket
G-3216	Jacuzzi	13-0061-01	Pump Gasket	G-3262	Hayward	SPX1025Z3	SP-1025 Filter Slip Washer
	Jacuzzi	13-0150-02	VB-21 Gasket		Hayward	SPX1035C	SP-1035 AV Main Drain Fiber Sealing Slip Gasket
G-3217	Jacuzzi	13-0277-01	4 Way Valve Gasket				

GASKETS-LISTED IN SSC# ORDER

SSC#	FITS OEM	FITS OEM#	DESCRIPTION	SSC#	FITS OEM	FITS OEM#	DESCRIPTION
G-3263	Pentair/PF	--	Washer	G-4015	Pentair/PF	19-5004	Poly Gasket
G-3264	Doughboy	310-1039	Tube to Spin-O-Cycle Gasket	G-4016	Laars	--	2 Button Command Center
	Lomart	053-047	Gasket		Len Gordon	--	Face Plate Gasket
G-3265	Raypak	800007	2" Unitherm Gasket	G-4017	Laars	S-245	Heater Gasket
G-3266	Marlow	--	VP-153 Strainer Body Gasket	G-4018	Comfortzn.	GKT-7402	Small Bucket Gasket (For Kit Also Order G-4007)
	Marlow	VP-153	Strainer Body Gasket	G-4019	Swimrite	36-828-136	Mixing Box Heater Gasket
G-3268	Hayward	SPX1500X	Pump Gasket		Swimrite	36-828-146	Mixing Box Cover Gasket
G-3269	Muskin	54017	Valve Cover Gasket	G-4020	Laars	S-248	Heater Gasket
G-3271	Pentair/PF	27-3097	Brass Backwash Valve Cap Gasket	G-4021	Comfortzn.	GKT-1930	CZ/HMZ Gasket
G-3273	Muskin	037-3408	Drain Cap Gasket	G-4023	South Seas	VB12	Outlet Heater Gasket
G-3274	Laars	E-327	Heater Gasket	G-4024	Laars	S-246	Heater Gasket
G-3275	Aqua Flo	91500150	A Series 5" Trap Gasket	G-4025	Anthony	15981	Inlet/Outlet Heater Gasket
	Aqua Flo	AF-12	Trap Gasket	G-4026	Coleco	30483	Hydro Skim Gasket
	Premier	VB38	Volute Gasket	G-4027	Laars	S-055	Heater Gasket
	Swimrite	60-828-274	P/V Pump Gasket	G-4029	Doughboy	307-1027	Skim-Line Face Plate Gasket
G-3277	American	501407	1 1/2" Mutliport Valve T/M Series Gasket	G-4029A	Doughboy	307-1027	New Style Skimmer Gasket-Wider
	Hayward	SPX0710Z1	Non-Metallic Bearing Gasket	G-4030	Doughboy	307-1005	MY205 Skimmer Gasket (For Kit Order 2)
	Hayward	SPX0710Z14	Non-Metallic Bearing Gasket	G-4031	Pentair/PF	51-3033	Skimmer Gasket
	Hayward	SPX0710Z16	Non-Metallic Bearing Gasket	G-4032	Aqua Lead.	--	Skimmer Face Plate Gasket
G-3278	Doughboy	307-1003	Cartridge Gasket	G-4033	Martec	320-108	Flange Gasket
G-3280	Laars	F-111	Heater Gasket	G-4034	Cascade	500010	Aqua Genie Faceplate Gasket-Rubber
G-3281	Doughboy	327-1007	Friction Washer	G-4035	Cascade	500011	Aqua Genie Oriface Gasket
G-3282	Diaclear	035-3400	HPE Diaclear Gasket	G-4036	Martec	610-112	FAS Skim Filter Gasket
G-3283	Bilnor	1743	Skimmer Gasket	G-4037	Laars	S-700	Temp Control Gasket
G-3284	Sta Rite	42001-0066S	Ignitor Gasket	G-4038	King	01-22-7850	King Tech Scoop Gasket
G-3400	Pentair/PF	55-2471	Liner Sealing Rim Gasket		King	01227856	Scoop Gasket
G-3401	Sta Rite	07017-0079	Drain Gasket		King	01-22-7856	Scoop Gasket
G-3402	Olympic	ACM-97G	Main Drain Gasket	G-4040	Acura	0163	Turbo Blower Cover Gasket
G-3403	Muskin	54055	Tank Gasket	G-4041	Hayward	SPX1094G	Skimmer Gasket-Rubber
G-3404	Marlow	P48690	L Stockline Pump Volute Gasket	G-4042	Doughboy	308-1089	DIX Skimmer Gasket
G-3405	Muskin	54076	Poly Element Filter Gasket		Lomart	308-1089	DIX Skimmer Gasket
G-3406	Jacuzzi	13-0011-02	2" Plug Gasket	G-4043	Coleco	38213	Skimmer Gasket
G-3407	Jacuzzi	13-0013-00	1 1/2" Plug Gasket		Doughboy	308-1068	S-12, 60-4012 Skimmer Gasket
G-3408	Sta Rite	33455-8043	Commercial Impeller to Shaft Washer		Lomart	308-1068	S-12, 60-4012 Skimmer Gasket
G-3409	Sta Rite	33455-8044	Commercial Impeller to Shaft Sleeve Gasket	G-4044	Sundance	6560-045	Hi Flo Heater Box Gasket
G-3410	Sta Rite	33450-8042	Commercial Volute Discharge Gasket	G-4045	Sundance	6560-046	Hi Flo Heater Element Gasket
G-3411	Sta Rite	33450-8041	Commercial Volute Suction Gasket	G-4046	Jacuzzi	01-0990-00	JWB Whirlpool Gasket
G-3412	Sta Rite	S04757	Commercial Volute to Bracket Gasket	G-4047	Hydro Air	16-5623	Verta'ssage Backing Plate Gasket
G-3414	Marlow	471210	4 SPC Gasket	G-4048	Hydro Air	16-5004	Hydr'ssage Cannister Gasket
G-3415	Marlow	470400	4 SPC Gasket	G-4049	Astral	1461R0001	Skimmer Gasket
G-3416	Equator	19-0552-1	Main Drain Face Ring Gasket	G-4050	Sta Rite	0956-0150	Standard Skimmer Gasket
G-4001	Aqua Sports	SMS-1094G	Face Plate Gasket (for Kit Order 2)	G-4051	Clayton	P-4450	Face Plate Gasket
	Hayward	SPX1090E	Vinyl Skimmer Gasket-Rubber	G-4052	Jacuzzi	13-0014-09	Gasket
	Muskin	098-7235	Skimmer Gasket-Rubber	G-4053	Waterway	711-4100	Wide Mouth Gasket
	Season Mstr	SMS-1094G	Face Plate Gasket (for Kit Order 2)	G-4054	Olympic	GAS-1096-G	Widemouth Gasket for ACM96 Skimmer
G-4002	American	451170	Twin Port Skimmer Sealing Gasket	G-4055	Astral	00273R0001	Gasket
G-4003	Edgewood	--	Inlet Heater Gasket		Hercules	1370097	Skimmer Gasket
G-4004	Edgewood	--	Outlet Heater Gasket	G-4056	Lochinvar	GKT-2400	Heat Shield Gasket
G-4005	Anthony	15147	Dual Housing Heater Gasket	G-4058	Olympic	WP-83W	Regular Gasket for Widemouth Skimmer
G-4006	Anthony	--	Inlet/Outlet Gasket	G-4059	Olympic	ACM-83C	Rubber Skimmer Gasket (For Set Order 2)
G-4007	Comfortzn.	GKT-7401	Large Bucket Gasket (For Kit also Order G-4018)	G-4060	Sta Rite	0956-0152	Above Ground Skimmer Wide Mouth Gasket
G-4008	American	850016	Liner Gasket-Rubber (For Kit Order 2)	G-4061	Muskin	54028	Skim Filter Body Gasket
	Sta Rite	8653-7	Skimmer Gasket	G-4062	Aquavac	78005	Tiger Shark Bottom Lid Gasket
G-4011	South Seas	VB11	Inlet Heater Gasket	G-4063	Jandy	2644	Valve Actuator Gasket
G-4012	Sta Rite	8652-5	U-3 Skimmer Face Plate Gasket	G-4064	Hayward	SPX1085D	Skimmer Gasket for 1085-Rubber
G-4014	Muskin	038-3458	Skimmer Gasket	G-4065	Hayward	SPX1084B	Skimmer Gasket for 1084-Rubber

GASKETS-LISTED IN SSC# ORDER

SSC#	FITS OEM	FITS OEM#	DESCRIPTION	SSC#	FITS OEM	FITS OEM#	DESCRIPTION
G-4066	Hayward	SPX1090WMSG	Skimmer Gasket for Above Ground Widemouth (for kit order 2)	G-4204	Sta Rite Swimrite	WC20-02 30-828-911	Filter Gasket Sight Glass Gasket
G-4067	Hayward	SPX1097E	Skimmer Gasket for 1097-Rubber	G-4205	Regal	G-203	Chlorinator O-ring
G-4102	Jacuzzi	13-0880-00	M/V Gasket	G-4206	Sta Rite	P64-069 C69-002	P/V Sight Glass Gasket Duraglass Pump Slinger Gasket
G-4103	Hayward	SPX0603F	Cover Gasket	G-4207	American Premier	-- 21-108 25-575	Rubber Washer Rubber Washer Neptune Sand Filter Gasket
G-4104	Pentair/PF	35-2627	Backwash Valve Gasket Replaces 35-3500	G-4208	Swimrite	36-828-453	Washer
G-4105	Sta Rite	WC20-16	Sand Filter Gasket	G-4209	A.O. Smith	99659-1	Inlet Manifold Gasket
G-4110	Hayward	SPX0577Z1	Deck Box Cover Gasket	G-4210	Laars	--	Aqua Dyne Round Gasket
G-4111	Hayward	CX25003Z2	Gasket	G-4211	Laars	S-157	Heater Gasket
G-4112	Hayward	SPX0605F	Cover Gasket	G-4212	Hayward	DEX2400S5	Micro Clear Filter Relief Valve Tank Gasket
G-4114	Coleco	30484	Return Fitting Gasket	G-4214	Capitol Hayward	G-106 SPX0102Z32	Chlorinator Gasket Gasket
G-4115	Sta Rite	WC20-05	Filter Gasket	G-4215	Ampro	900-4	Upper Cap Washer
G-4116	Hayward	SPX1048D	Main Drain Vinyl Gasket-Rubber	G-4216	Baker Hyd	17B1085	Cartridge Filter Gasket
G-4119	Hayward	SPX1500H	Pump Gasket-Rubber	G-4217	Anthony	--	Oval Lid Gasket
G-4120	American	390008	Power Pump Gasket	G-4218	Hayward Muskin	SPSTX0340Z1 54027	6" In Line Trap Cover Gasket 8" HMLI Tank Gasket
G-4121	Hayward	SPX0602F	Gasket	G-4219	Doughboy	308-1145	Drain to Valve Gasket
G-4122	Pentair/PF	35-3500	Hydro Pot to Volute Gasket-Rubber	G-4220	Doughboy	053-133 307-1023	Gasket Deluxe Skimmer 90 Degree Radius Fitting Gasket
G-4123	Purex	70943	C Series Pot to Volute Gasket	G-4221	Doughboy	308-1110	Gasket
G-4124	Hayward	SPX1411Z12	Gasket for SP-1411, 1407-1	G-4222	American	422160	Power Glass Gasket
G-4125	Jacuzzi	13-0329-09	Gasket	G-4222	Misc	--	3" Quick Disconnect Fitting Gasket
G-4128	Misc	--	Light Deck Box Gasket		Monarch	199696	Seal Gasket
G-4129	Purex	P-11200	Flo Valve Gasket	G-4223	Homelite	62363-A	Gasket
G-4130	American	510004	Multiport Cover Gasket		Jacuzzi	13-0414-05	Cartridge Filter Tube Gasket
G-4131	Doughboy	307-1002	MX60RP Inlet Fitting Gasket	G-4224	Anthony	15448	Rubber Tube Seal Gasket
G-4132	Bilnor	1750	Return Fitting Gasket		South Seas	--	Small Rubber Gasket
G-4133	Bilnor	1761	Return Fitting Gasket	G-4225	Wallace	37661	Chlorinator Gasket
G-4134	Hayward	SPX1408C	Vinyl Eyeball Gasket	G-4226	Muskin	037-5071	Grid Post Gasket
G-4136	Speck	2926999990	Sand/DE Filter Rim Gasket		Wallace	44122	Chlorinator Gasket
G-4137	Acura	0167	Turbo Blower Motor Mount Gasket	G-4227	Baker Hyd	35B1116	Spa Pak Pump Slinger Gasket
G-4138	Speck	2303002002	Jet Gasket		Hayward	SPX0125F	Motor Shaft Slinger Gasket
G-4139	Speck	2301001013	Badujet/Stream Gasket	G-4228	Misc	--	2" Fire Hose Gasket
G-4140	Speck	2302002060	Badujet IT Gasket	G-4229	Buster Cr.	20-1040	Pump Gasket
G-4141	Jacuzzi	13-0006-09	Vinyl Return Fitting Gasket		C & R	20-1040	Pump Gasket
G-4142	Hydro Air	16-5523	Thera'ssage Gasket	G-4230	Hayward	SPX1438J	Pro Jet Gasket
G-4143	Astral	02064	Sand Filter Gasket	G-4231	Jacuzzi	13-0300-02	Flange Gasket
G-4144	Astral	545R0305	Bulkhead Gasket		Baker Hyd	284860	Old Spa Pak Pump Slinger Gasket
G-4145	Astral	365R0002	Light Gasket		Marlow	28484	AF Series Pump Slinger Gasket-All Models
G-4146	Astral	687R0303	Sand Filter Gasket	G-4232	Regal	G-204	Chlorinator Gasket
G-4147	Astral	271R0002	Main Drain Gasket	G-4233	Paddock	--	1 1/4" - 1 1/2" Flat Gasket
G-4148	Sta Rite	05057-0667	Light Niche Gasket	G-4234	Homelite	62665-A	Impeller Housing Gasket
G-4149	Purex	70935	Cover Gasket	G-4237	American	--	Olympian Filter Gasket
G-4150	Astral	788R4140120	Gasket		American	510137	Bulkhd Gsk-Titan, Sandpiper 18&24, Carbide, Quantum
G-4151	Jacuzzi	13-1207-04	Main Drain Gasket		Misc	--	3" Discharge Hose Flat Washer
G-4152	Jacuzzi	13-0864-00	Main Drain Gasket	G-4238	Misc	--	3" Fire Hose Gasket
G-4153	Astral	02063	Gasket	G-4238	Marine	3660	Flat Rubber Gasket
G-4154	Astral	02065	4" Gasket	G-4239	Sta Rite	WC20-15	Sand Filter Gasket
G-4155	Astral	02068	6" Gasket	G-4240	Misc	--	Fire Hose Coupling Gasket
G-4156	Astral	00690R0402	Sand Filter Drain Gasket	G-4241	American	791143	Fun Light Gasket
G-4157	Astral	00546R0202	Interior Bulkhead Gasket		Doughboy	308-1147	Viewport Gasket
G-4158	Astral	00270R0001	Gasket		Lomart	053-140	Viewport Gasket
G-4159	Sta Rite	05161-0006	Niche ABS Liner Gasket	G-4242	South Seas	--	Bypass Gasket
G-4160	American	872063	Aqua Lumin Sealing Gasket	G-4243	Hayward	SPX1035B	SP-1035 AV Main Drain Gasket
G-4162	Doughboy	--	New Main Drain Gasket	G-4244	Hydro Air	10-3804	Wall Fitting Gasket
G-4163	Arneson	AXL12	Main Drain Gasket		Waterway	711-6020	2 1/2" Heater Union Gasket
G-4164	American	467220	Aqua Fan Gasket	G-4245	Purex	P-11125	Tropic Inlet/Outlet Heater Gask
G-4164	Purex	70947	Sunlite Niche Face Ring Gasket				
G-4165	American	792004	Standard Hole Niche Gasket (for kit order 3)-Rubber				
G-4186	Jacuzzi	13-0314-06	Pump Gasket-Rubber				
G-4201	Doughboy	308-1081	Valve Cap Gasket				
G-4202	Lomart	053-157	Gasket				
G-4202	Doughboy	308-1083	Gasket				
G-4203	Jacuzzi	13-0244-01	Filter Gasket				

GASKETS-LISTED IN SSC# ORDER

SSC#	FITS OEM	FITS OEM#	DESCRIPTION	SSC#	FITS OEM	FITS OEM#	DESCRIPTION
G-4246	Raypak	800164	Element Gasket	G-4290	American	461130	2" ID Thick Gasket
G-4247	Purex	70943	Flange Gasket		American	872002	Thin Line Spa Skimmer Gasket
G-4248	Paddock	--	2" Flat H&L Gasket		American	872012	2" ID Thick Gasket
G-4249	Hayward	SPX1434L	Jet Air III Gasket		Hayward	SPX1023Z12	Return Fitting Gasket
G-4250	Doughboy	308-1076	Gasket		Season Mst	SMS-1023G	Skimmer Wall Fitting Gasket (For Kit Order 2)
G-4251	Swimrite	28-828-325	Washer	G-4291	Pentair/PF	19-2032	Gasket
G-4252	Jacuzzi	13-0275-03	4-Way Valve Gasket	G-4292	Premier	29-869	Rubber Washer
G-4253	Slinger	--	Water Slinger-1 1/4" OD x 11/32" ID	G-4294	Muskin	54010	Viewport Gasket
	Sta Rite	C69-002	Water Slinger Gasket (Replaces N69-001)	G-4295	Astral	00545R0214	Gasket
	Sta Rite	N69-001	Water Slinger Gasket (C69-002 Replaces This)		Coleco	34027	Gauge Gasket
G-4254	Paddock	--	Trimmer Lid Keyhole Gasket		Pentair/PF	15-4713	Sand Drain Gasket-15"
G-4255	South Seas	--	Large Rubber Gasket	G-4296	Pentair/PF	15-4539	1 1/2" Super Flow B/H Gasket
G-4256	Slinger	--	Water Slinger-1 3/4" OD x 13/16" ID	G-4297	American	791048	Rubber Washer
	Sta Rite	C69-012	C Pump Water Slinger Gasket	G-4298	American	530004	Shaft Sleeve Gasket
G-4257	Astral	103R0003	Drain Gasket		Marine	--	DE Spin Filter Shaft Sleeve Gasket
G-4258	Jacuzzi	13-0872-06	Valve Gasket	G-4299	Hayward	SPX1025Z1	Return Fitting Gasket
G-4259	Hayward	SPX1025Z12	SP-1025 Gasket (For Kit Order 2)	G-4300	American	510018	Multiport Valve Rubber Gasket (For Kit Order 2)
G-4260	Hayward	SPX1432E	Jet Air Mini Jet Gasket		American	510087	Rubber Sight Glass Washer
G-4261	Hayward	SPX0072C2	Gasket	G-4303	Laars	225	3/16" Thick Washer
G-4262	Laars	S-151	Heater Gasket		Laars	S-057P	Aqua Dyne 3/16" Thick Washer
G-4263	Doughboy	348-1033	Slinger Washer	G-4304	Laars	S-156	Heater Gasket
	Lomart	046-029	Gasket	G-4305	Doughboy	307-1007	Skim Filter Drain Cap Gasket
	Slinger	--	Water Slinger-1 5/32" OD x 7/16" ID	G-4306	Hayward	SPX107242	Gasket
G-4264	Hayward	SPSTX0345H	8" In Line Trap Cover Gasket	G-4309	Coleco	34023	Gasket
G-4265	Jacuzzi	47-0222-07	PM Filter Valve Gasket		Doughboy	308-1109	Silica Valve Body Gasket/Washer
	Pentair/PF	19-2404	SCS Return Sleeve Gasket		Lomart	053-029	Valve to Tank Gasket
G-4266	Purex	70942	Tropic Inlet/Outlet Gasket For All Models	G-4310	American	510061	Sight Glass Gasket
G-4267	American	510065	Air Relief Valve Sep. Tank Gasket		Anthony	--	Sight Glass Gasket
	Hayward	SPX1700FG	Washer		Jacuzzi	10-1462-07	Eye Seal Gasket
G-4268	Baker Hyd	31B0015	Baker Valve Top Plate Gasket		Premier	SG-364	Sight Glass Gasket
	Purex	70152	Index Plate BH Valve Gasket	G-4311	American	550009	Sandpiper Hub Gasket
G-4269	Hayward	SPSTX0330Z1	4" In Line Trap Cover Gasket	G-4312	Regal	G-202	Chlorinator Gasket (For Kit Order 2)
G-4270	Hayward	SPSTX0335Z1	5" In Line Trap Cover Gasket	G-4314	Raypak	800014B	Gemini Tube Seal Gasket
G-4271	Baker Hyd	31B9006	Sand Filter Bulkhead Fitting Gasket	G-4315	Laars	--	Large Tube Round Gasket
	Purex	70169	Bulkhead Gasket		Laars	S-056	Large Tube Round Gasket Washer
G-4272	Hayward	SPSTX0325F	3" In Line Trap Cover Gasket	G-4316	Laars	--	Washer
G-4273	Hayward	SPSTX0315Z1	2" In Line Trap Cover Gasket		Laars	S-056P	Aqua Dyne Heater Washer
G-4274	Sta Rite	2PLL	Light Lens Gasket	G-4319	American	510054	6 Position Valve Sight Glass Gasket
G-4275	Swimrite	36-828-280	Washer		Astral	00541R0402	Persius Sand Filter Drain Gasket
G-4276	Doughboy	308-1146	Viewport Lid Gasket		Hydrotech	B154	Brominator Air Vent Gasket
	Lomart	053-120	Viewport Lid Gasket	G-4320	Astral	00612R0001	Filter Gasket
G-4277	Marlow	--	AF Pump Cover Gasket (All Models)		Swimrite	14-828-381	Block Hose Washer
G-4278	American	510136	Bulkhead Gasket		Swimrite	36-828-114	Heater Gasket
G-4279	Rainbow	17-2015	Lifeguard Cartridge Filter Gasket	G-4322	Marine	1220	Flat Rubber Bushing Gasket
G-4280	Hayward	SPX0710R	Multiport Valve Sight Glass Gasket		Premier	122	Rubber Washer
G-4281	Muskin	037-5002	Air Relief Valve Assembly Gasket	G-4323	Muskin	038-3416	Tank Tube Valve Gasket
G-4282	Pentair/PF	19-2031	Crankshaft Sleeve Flat Gasket	G-4324	Doughboy	308-1139	Flat Cut Gasket
G-4283	Premier	27-379	Hercules Filter Lid Gasket		Lomart	053-211	Gasket
G-4284	American	392048	Eagle Gasket		Pentair/PF	15-4538	2" Bulkhead Fitting Gasket
G-4285	American	395001	Noryl Pump Slinger Gasket	G-4325	Hayward	SX0200Z9	Sand Filter Drain Gasket
	Purex	72187	Eastside Pump Water Slinger Gasket	G-4326	Anthony	27111	Large Tube Seal Gasket
	Slinger	--	Water Slinger-1 1/4" OD x 5/8" ID		Laars	--	Small Tube Round Gasket
G-4286	Laars	S-159	Heater Gasket		Laars	S-057	Tube Round Gasket
G-4287	Paddock	--	3/4" Sight Glass Gasket	G-4327	Anthony	12388	SS Ditron Upright Filter Air Release Valve Gasket
G-4288	Muskin	038-3424	Tank Gasket		Bio Lab	5470	Tygon Washer
					E-Z Chlor	12690-26	Saddle Fitting Gasket
					Rainbow	17-2033	Tube Fitting Gasket
				G-4328	Hayward	SPX0071C2	Sight Glass Gasket (For Kit Order 2)
					Muskin	038-3457	Valve Body Gasket-Flat

GASKETS-LISTED IN SSC# ORDER

SSC#	FITS OEM	FITS OEM#	DESCRIPTION	SSC#	FITS OEM	FITS OEM#	DESCRIPTION
G-4329	American Purex	374058 70951	Heater Gasket Tube Seal Gasket	G-4397	Brett	63-0001	Current Collection Gasket
G-4330	Swimrite	36-828-122	Tube Heater Gasket	G-4398	Pentair/PF	07-0951	Tube Seal Gasket
G-4331	American	910043	Rubber Washer	G-4399	Jacuzzi	13-1021-08	Fitting Gasket
G-4332	Muskin	038-3421	Spin Filter Gasket	G-4401	Baracuda	ADG-5	Universal Pool Cleaner Floor Gasket
G-4333	Hayward	SPSTX0305F	1 1/2" In Line Trap Cover Gasket		Jandy	4487	Vac Floor Gasket
G-4334	American	982085	Washer		Kreepy	12866	Universal Pool Cleaner Floor Gasket
G-4335	Harmsco	639	Cover Gasket	G-4402	Harmsco	635	15 Hole Cover Gasket
G-4336	A.O. Smith	99659	Outlet Manifold Gasket	G-4403	Harmsco	636	15 Hole Cover Gasket
G-4337	Sta Rite	WC20-11	Filter Gasket	G-4404	Harmsco	671	27 Hole Cover Gasket
G-4338	Rainbow	17-2222	Cartridge Gasket	G-4405	Coleco	--	Hydro Gasket
G-4339	Onyx	ON15	1 1/2" Spa Union Gasket		Coleco	37280	Hydro Skimmer Float Gasket
G-4340	Onyx	ON20	2" Spa Union Gasket	G-4406	Sta Rite	PS20-011	Top Plate Gasket
G-4341	Laars	S-737	Tank Cover Gasket		Sta Rite	PS20-018	Pump Gasket
G-4342	Martec	420-509	BJ 5000 Gasket	G-4407	Aqua Flo	91500250	A Series Drain Gasket
G-4343	Speck	2301002025	Baduget/Stream Gasket		Aqua Flo	FF-12-02	100% Drain Gasket
G-4344	Hydro Air	10-5847	Mark II Jet Assembly Gasket	G-4408	Raypak	800204	Bypass Gasket
G-4345	Brett	61-0001	EM 103 Heater and Pump Gasket	G-4409	American	395012	Pot to Volute Pump Gasket
G-4346	Ampro	641-36	Dura Flo Pump Gasket	G-4410	Jacuzzi	13-0178-01	U Pump Gasket
G-4347	Raypak	800086	155B Versa Gasket	G-4411	Sta Rite	C20-103	Duraglass Pump Gasket-Rubber (Larger Bolt Holes)
G-4348	Waterway	711-5000	Filter Niche Gasket	G-4412	Sta Rite	C20-031B	LT Series Seal Plate Gasket
G-4349	Ampro	512	AP900 P/PI Valve Gasket	G-4414	South Seas	--	Inlet Bypass Gasket
G-4350	Waterway	711-1290	Bath Jet Gasket	G-4415	Muskin	038-3410	Drain Cap Washer
G-4351	American	461352	Lux Spa Jet Gasket	G-4416	Purex	P-11250	Valve Gasket
G-4352	Martec	400-102	DS Filter, JM Jet Gasket	G-4417	Wallace	40336	Chlorinator Gasket
G-4353	Martec	410-506	Bath Jet Gasket	G-4418	Marine	1160	Bushing Cup Gasket
G-4354	Waterway	711-4750	Polyjet Gasket		Muskin	54003	Valve Waste Cap Gasket
G-4355	Waterway	711-1760	Bath Jet Gasket	G-4419	Swimrite	28-828-324	Bracket Mounting Gasket
G-4356	Waterway	711-4500	Power Jet Gasket	G-4420	Raypak	800075	Heater Gasket
G-4357	Raypak	800276	WHG 55A Gasket	G-4421	Premier	23-256	Rubber Disc
G-4358	Hydro Quip	61-0011	1 1/2" Heater Union Gasket	G-4422	Hayward	SPX1500RA1	Pump Check Valve Gasket
G-4359	Waterway	711-4000	1 1/2" Union Gasket	G-4423	Taylor	--	Aqualite PL-89 1603 Gasket
G-4360	Richardson	--	2" Heater Tailpiece Gasket	G-4424	Muskin	038-3457	1 1/2" Backwash Cap Gasket-Solid
G-4361	Richardson	--	Thick Sand Filter Gasket	G-4425	Doughboy	307-1001	Gasket
G-4362	Pentair/PF	27-1106	Thin Sand Filter Gasket		Doughboy	308-1072	Gasket
G-4363	Sylvan	59201200	Mounting Valve Sight Glass Gasket	G-4426	Sta Rite	J20-016	Well & Irrigation Pump Gasket
G-4364	Waterway	711-1750	Throttling Plug Gasket	G-4427	Jacuzzi	13-0239-08	5-Way Valve Gasket
G-4365	Waterway	711-1750	Polyjet Standard Gasket	G-4428	Guardex	P72999	Rubber Washer
G-4366	Hydro Air	10-3705	Air Control Valve Gasket		Purex	72999	Guardex Washer-Rubber
G-4367	Jacuzzi	13-1020-09	HT & WHJ Jet Gasket, Valve Gasket	G-4430	Purex	70944	Valve Gasket
G-4368	Hydro Air	10-2204	Air Control Valve Gasket	G-4431	Anthony	15029	Old Style Rear Header Gasket
G-4369	American	501133	Bulkhead Gasket	G-4432	Raypak	800187	Heater Gasket
G-4370	American	510133	Bulkhead Gasket	G-4433	Jacuzzi	13-0136-02	Flange Gasket
G-4371	Lomart	307-1023	DIX Skimmer Return Gasket	G-4434	Jacuzzi	13-0090-06	Pump Flapper Gasket
G-4372	American	711001	Mini Jet Wall Fitting Gasket	G-4435	Baker Hyd	35B1150	Spa Pak Pump Gasket
G-4373	American	470626	Luxury Collection Gasket		Little Giant	101601	Impeller Housing Gasket
G-4374	Waterway	711-9870	Ozone/Cluster Jet Gasket	G-4436	Sta Rite	C20-015	Pump Gasket
G-4375	Hydro Air	10-6003	Adjustable Skimmer Gasket	G-4437	E-Z Chlor	12690-22	Silicone Valve Seal Gasket
G-4376	American	472253	Diverter Jet Valve Gasket	G-4438	American	793006	Junction Box Sealing Gasket
G-4377	Hydro Air	10-5008	Whirlpool & USR Jet Gasket	G-4439	Muskin	038-3446	Adapter Gasket
G-4378	Brett	60-0002	Current Collector O-ring	G-4440	American	550060	Sahara Filter Manhole Gasket
G-4379	Martec	202-003	Suction Filter Flange Gasket	G-4441	Sta Rite	C20-103	Duraglass Pump Gasket-Rubber
G-4380	Astral	600R0205	Valve Plug Gasket		Sta Rite	C20-123	Trap Outlet Gasket
G-4381	Muskin	54013	Vac Attach Skimmer Gasket	G-4442	Laars	E-244	Heater Gasket
G-4382	Muskin	54004	3/4" Washer	G-4443	Hayward	SX0180G	Sand Filter Gasket
G-4383	Pentair/PF	07-4629	Commercial R Gasket	G-4444	Sta Rite	--	Aqua Flyte H&L Gasket
G-4384	Sta Rite	WC9-002	Sight Glass Gasket	G-4445	Ampro	513	AP900 P/PL Valve LW Gasket
G-4385	Paraport	C64069	Sight Glass Gasket	G-4446	Ampro	511	AP900 P/PL Valve WA Gasket
G-4386	Watermatic	1-110	Hopper Lid Gasket	G-4447	Jacuzzi	13-1022-07	Laser Sand Gasket
G-4387	Waterway	711-7000	Spa Jet Body Gasket	G-4448	Speck	2923141000	Model 21-80 Gasket
G-4388	Letro	JV-29	Jet Vac Gasket	G-4449	Misc	--	2" Discharge Hose Flat Washer
G-4389	Astral	544R0106	Gasket		Sta Rite	C20-123	Trap Outlet Gasket
G-4390	Rainbow	17-2263	1/2" Saddle Gasket	G-4450	Jacuzzi	13-0379-08	PJM Flange Gasket
G-4391	American	510173	Valve Gasket	G-4451	Watermatic	1-020	Rain Cover Gasket
G-4392	Richardson	5099-504	Air Bleeder Gasket	G-4452	Comfortzn.	CZXGKT7408	Bucket Gasket
G-4393	Hydro Quip	61-0001	Heater Union Gasket				(For Kit Order 2)

GASKETS-LISTED IN SSC# ORDER

SSC#	FITS OEM	FITS OEM#	DESCRIPTION	SSC#	FITS OEM	FITS OEM#	DESCRIPTION
G-4453	Cal Pump	--	Volute Gasket-No. 3	G-4639	Waterway	711-1930	75-125-200 Filter Drain Cap Gasket
G-4454	Little Giant	102601	Volute Gasket-No. 2	G-4640	Muskin	15-4713	Drain Gasket
G-4455	Pentair/PF	07-4015	Flow Valve Gasket	G-4641	Sta Rite	17140-0026	Flo Tec Pump Body Gasket
	Purex	74015	Flow Valve Gasket	G-4642	Waterway	711-4031	Heater Tailpiece Gasket
G-4456	Watermatic	1-370	Diverter Bracket Gasket	G-4643	Waterway	711-4050	1 1/2" Heater Tailpiece Gasket
G-4457	Little Giant	103601	Volute Gasket	G-4644	Waterway	711-4030	2" Heater Tailpiece Gasket
G-4458	American	863005	Drain Cap Gasket	G-4645	Hayward	--	Super Pump Drain Plug Gasket
G-4459	Jacuzzi	13-1023-06	CFR Gasket	G-4646	Purex	74565	New Style Whisperflo Seal Plate Gasket/O-ring (After 1994)
	K-D Pools	13-1023-06	Cartridge Filter Gasket	G-4647	American	510215	Eclipse Bulkhead Gasket
G-4460	Hayward	GMX0142DA2	Sand Filter Gasket	G-5001	Muskin	54008	Clamp Nut Gasket
G-4461	Misc	--	Oval Rope Eye Gasket	G-5002	Raypak	800086B	1" Square Cut O-ring
G-4462	Astral	00541R0404	Persius Sand Filter Drain Cap Gasket	G-5003	Hayward	SPX0125Z3	Volute Pump Diffuser Ring
G-4463	Laars	R03275	Header Gasket	G-5004	Laars	S-702	Heater Washer
G-4600	E-Z Chlor	824050	3/8" Saddle Gasket	G-5005	Laars	S-606	Heater Tube Gasket
G-4601	American Slinger	395001	Water Slinger		Laars	S-708	Heater Washer
		--	Water Slinger-1 1/2" OD x 1/2" ID	G-5006	Baker Hyd	00B7013	Filter Lid Ring (1969-71)
G-4602	Watermatic	1-190	Collar Gasket		Baker Hyd	00B7028	Baker II Clamp Ring
G-4603	Astral	713R0580030	Gasket		Purex	70211	OOB7013 Gasket V-Band Lid
G-4604	Astral	00361R0001	Light Gasket	G-5007	Sta Rite	--	Ring For HRP36 Filter
G-4605	Astral	00352R0010	Compression Ring Gasket	G-5008	Marlow	25784	Pump Cover Gasket
G-4606	Brett	37-0101BK	Light System Gasket		Purex	B-94	Square Cut Ring-Aqua Brominator CB8-4 to CB8-45
G-4607	American	470690	Micro Jet Gasket		Purex	CB8-45	Hydrotech Square Cut Ring
G-4608	American	472240	Diverter Jet Gasket-2 or 3 Port	G-5009	Hayward	SPX0145T	Pump Lid Gasket
G-4609	Waterway	711-1920	Clearwater Sand Top Gasket	G-5010	Baker Hyd	374790	Old Spa Pak Pump Gasket
G-4610	E-Z Chlor	168090	Bottom Flowmeter Gasket		Marlow	37479	Mardur Strainer to Tank Gasket (All Models)
	E-Z Chlor	824090	Bottom Flow Meter Gasket	G-5011	Baker Hyd	00B7031	Top Mount Sand Filter Gasket
G-4611	American	863005	Predator Drain Cap Gasket	G-5012	Sta Rite	14962-21	Caprice Valve 1 1/2" Square Ring
G-4612	Laars	R00114	By-Pass Valve, Flow Control Gasket	G-5014	Baker Hyd	374780	Old Spa Pak Pump Gasket
G-4613	Muskin	54029	Discharge Fitting Intake Gasket		Marlow	37478	Mardur 1/3 to 1 HP Pump Cover Gasket
G-4614	Sta Rite	05103-0101	Niche Gasket	G-5016	Baker Hyd	394040	Old Spa Pak Pump Gasket
G-4615	Sta Rite	17150-0007	4" Trap Gasket		Jacuzzi	47-0466-02	Strainer and Case Gasket
G-4616	Pentair/PF	61-4562	Washer		Marlow	39404	1 1/2 & 2 HP Mardur Pump Seal Gasket
G-4617	Bio Lab	254840MN	Brominator Gasket	G-5017	Marlow	25476	3/4 & 1 1/2 HP H Series Pump Diffuser Gasket
G-4618	Jacuzzi	13-1075-03	2" Valve Gasket	G-5019	Marlow	29038	Pump Gasket
G-4619	Sta Rite	14971-0011	2" Multiport Valve Sight Glass Gasket	G-5022	A.O. Smith	23789	Spa Element Gasket
G-4620	Sta Rite	L20-40	PLBC Small Gasket	G-5023	Jacuzzi	13-0378-09	5-Way Valve Gasket
G-4621	Rainbow	18658	Leaf Trap Gasket for Cartridge		Jacuzzi	47-0358-50	Square Cut O-ring
G-4622	Fiberstars	A9982	Large O-ring/Gasket		K-D Pools	13-0378-09	Sand Filter Square Ring Gasket
G-4623	Jacuzzi	13-0015-08	Return Flange Gasket	G-5024	American	510076	Separation Tank Lid Ring
G-4624	Purex	75114	Ortega Rubber Washer		Marine	99-8660-5	Large Separation Tank Gasket
G-4625	American	982214	2" P Valve Sight Glass Gasket		Sta Rite	WC20-04	9.5" Separation Tank Gasket
G-4626	Comfortzn.	CZXGKT9216	C-SPA XI Inlet/Outlet Gasket	G-5026	Jacuzzi	47-0248-56	Dial Valve Square Ring
G-4627	Waterway	711-4020	2"-2 1/2" Union Gasket	G-5027	Jacuzzi	13-0377-00	Multiport Valve Gasket
G-4628	American	422240	Diverter Jet Gasket-2 or 3 Port	G-5028	Doughboy	308-1140	2" Inspection Port Ring
G-4629	Slinger	--	Water Slinger-1 3/8" OD x 1/2"ID-For 48 Frame Above Ground Pumps		Lomart	053-215	Ring
G-4630	Astral	00600R0001	Top Mount M/V Sight Glass Gasket	G-5031	Jacuzzi	47-0232-54	Magnum Diffuser Square Ring
G-4631	Astral	11130R0006	Offline Chemical Feeder Gasket	G-5033	Hayward	SPX1485C	Sand Filter Elbow Ring
G-4632	Waterway	806-0003	Clearwater Feeder Gasket	G-5034	Sta Rite	L21-001	Pump Diffuser Ring
G-4633	Astral	00470R0319	Chemical Feeder Drain Gasket	G-5035	Jacuzzi	16-0920-12	XL-VII Pump Ring
	Purex	74629	Drain Gasket		Jacuzzi	47-0258-61	L Series Pump Square Ring
G-4634	Jandy	R0354400	SF-S Sand Filter Half Union Gasket		Jacuzzi	47-0463-05	F Series Pump Square Seal Ring
G-4635	Master	08490-0031	Master Turbo Clean Head Square Ring Seal	G-5036	Raypak	800080B	2" Flange Gasket
G-4636	Hayward	SPX1450G	Turbo Boost Spa Jet Jumbo Return Fitting Gasket	G-5039	Baker Hyd	35B1117	Spa Pak Pump Lid Gasket
G-4637	Baker Hyd	30C3015	Sight Glass Gasket		Hayward	SPX0125T	Pump Lid Ring
	Baker Hyd	30C3115	Sight Glass Gasket	G-5040	Marlow	--	1-2 HP AF Pump Diffuser Gasket
G-4638	Hayward	SPX1023Z3	Inlet/Outlet Washer/Gasket-Rubber	G-5041	Jacuzzi	13-0881-09	Underdrain Gasket
				G-5043	Arneson	D-10	Hose Washer

GASKETS-LISTED IN SSC# ORDER

SSC#	FITS OEM	FITS OEM#	DESCRIPTION	SSC#	FITS OEM	FITS OEM#	DESCRIPTION
	Letro	LD-10	Hose Washer	G-5120	Pentair/PF	27-1148	Spider Gasket-5 Spoke
	South Seas	--	Tube Gasket		Sta Rite	14971SM20E12	Spider Gasket-5 Spoke
G-5045	American	395013	Seal Plate Ring (After 7/75)	G-5124	Sta Rite	05057-118	Light Lens Gasket
G-5046	Jacuzzi	47-0462-06	Square Diffuser Gasket	G-5126	Hayward	SPX0540Z2	Light Lens Gasket
G-5047	Sta Rite	489031	Head Quad Ring		Purex	70945	Light Lens Gasket
	Sta Rite	8490-31	Head Quad Ring	G-5129	Marine	1560	V Cup O-ring-Square Cut
G-5048	Laars	--	Tube Late Style Gasket		Pentair/PF	88-500-1	Old Style Manifold V-ring (SCS Series Before 1977)
	Laars	S-152	Aqua Dyne Late Style Tube Gasket	G-5131	Hydrel	8092-S	Lens Gasket
G-5050	Wallace	27594	Chlorinator Gasket	G-5136	Pentair/PF	88-500-3	Large Manifold V-ring
G-5051	Wallace	27593	Chlorinator Gasket	G-5142	Hayward	SPX0603Z2	Valve Teflon Piece With Split
G-5052	Baker Hyd	374820	Old Spa Pak Pump Gasket		Hayward	SPX0605Z2	Valve Teflon Piece With Split
	Marlow	37482	Mardur Pump Seal Plate Gasket	G-5146	American	510013	Multiport Valve Teflon Backup Ring
G-5053	Muskin	037-3417	Body Ring	G-5149	Laars	S-987	Jacket Hole Plug
G-5055	American	510056	Small Separation Tank Ring	G-5150	Onyx	ONHSUPREME	Spa Pack Gasket
	Marine	99-8088-5	Small Separation Tank Ring	G-5151	Laars	S00531	Heater Flange Gasket
G-5057	Laars	R0011400	H1-E2 Heater By-Pass Valve Gasket	G-5152	Hayward	ECX1105	DE Diaphragm Gasket for EC-65, 75-No Holes
	Laars	S-154	Flange Gasket	G-5153	Hayward	ECX1003	DE Diaphragm Gasket for EC-30, 40, 50-With Holes
	Laars	S-741	Flow Control Gasket (For Kit Order 3)	O-RING / GASKET KITS			
G-5058	Baker Hyd	00B7027	New Style Bulkhead Adapter Ring-Square Cut	K-6001	Hayward	SPX0735-GA	Vari Flo Valve O-ring Kit
	Purex	70213	New Style Bulkhead Union Ring	K-6002	Hayward	SPX0501-HJ	Light Lens O-ring Set
	Sta Rite	--	Ring For HRP36 Bulkhead Connection	K-6003	Hayward	CLX0200-LA	Chlorinator O-ring Kit
G-5060	Jacuzzi	47-0258-53	L Series (After 5/88), CFT & RPZ Square Ring	K-6004	Mec-O-Matic	88004-73	HJ & Barracuda O-ring Kit
	K-D Pools	47-0258-53	LR6 Gasket	K-6005	Lomart	--	Backwash Plunger Pipe O-ring Kit
G-5061	Pentair/PF	35-5329	New Style Challenger Front Housing Square Ring	K-6006	Baker Hyd	00B7015	Piston O-ring Kit
G-5062	Muskin	54019	Cartridge Housing Gasket		Baker Hyd	31B0024	Piston O-ring Kit
G-5063	Laars	R-508	Header Gasket		Purex	70155	Piston O-ring Kit
G-5064	Richardson	5099-518	Sand Gasket		Sta Rite	--	31B0024 O-ring Repair Kit
G-5065	Little Giant	928028	Terminal House Gasket	K-6007	Sta Rite	WC298-88	PVC Valve Repair Parts Kit
G-5066	Laars	E-1164	Gasket/O-ring	K-6008	Premier	30-828-750	1 1/2" Valve O-ring/Gasket Kit
G-5067	Little Giant	928007	Square Cut Ring	K-6009	Premier	30-828-754	2" Valve O-ring/Gasket Kit
G-5069	Marlow	26144	H Diffuser Gasket-3/4 to 1 1/2 HP	K-6011	Deluxe Htr	20-3212	O-ring/Gasket Kit
G-5071	Little Giant	928024	Gasket	K-6012	Muskin	72034	Cartridge Housing Gasket/O-ring Kit
G-5072	Sta Rite	33455-1047	Impeller Screw Gasket	K-6014	Muskin	72035	3 Position Valve Gasket Kit
G-5073	Marlow	15621	AF Diffuser Gasket-1-2 HP	K-6015	Muskin	72036	5 Position Valve Gasket Kit
G-5074	Marlow	28983	H Diffuser Gasket-1/3 & 1/2 HP	K-6016	Muskin	72039	DLX Skimmer Gasket Kit
G-5075	E-Z Chlor	824090	Bottom Flowmeter Gasket	K-6017	Muskin	72038	Standard Skimmer Gasket Kit
G-5076	Pentair/PF	15-4494	Square Ring	K-6018	Muskin	72040	Resin 5 Position Gasket/O-ring Kit
G-5077	Hydrotech	25475	Lid Ring	K-6019	Muskin	72037	Fill Port Gasket Kit
G-5078	Marlow	32540	AF Strainer Cover Gasket	K-6020	Hayward	DEX2420Z8A	Swimclear Cartridge Filter O-ring Kit
G-5079	Pentair/PF	15-2509	Square Gasket	K-6021	Raypak	006724F	O-ring Kit
G-5104	American	510084	6 Spoke Spider Gasket (Prior to 1976)	K-6022	Polaris	G-58	O-ring Kit for 280
G-5105	American	510084	5 Spoke Spider Gasket (After 1976)	K-6023	Hayward	CCX1000Z5	O-ring Kit for Gauge Adapter and Air Relief Valve
G-5106	Astral	597R0102	5 Spoke Spider Gasket	Pipe Flange Gaskets are listed on pages 112-113.			
	Baker Hyd	30C3011	1 1/2" Spider Gasket-5 Spoke				
	Hayward	SPX0710XD	5 Spoke Spider Gasket (After 1977)				
	Pentair/PF	27-1104	Spider Gasket for 1 1/2" Valve				
G-5108	Hayward	SPX0710D	6 Spoke Spider Gasket (Prior to 1977)				
G-5111	Pentair/PF	27-3012	1 1/2" Old Style Piston Seal				
G-5112	Pentair/PF	27-3160	1 1/2" New Style Piston Seal				
G-5114	Pentair/PF	27-3059	2" Piston Seal Ring				
	Premier	21-505	Piston O-ring				
G-5117	Purex	71722	Piston O-ring				
G-5119	Ameson	A-40	A1, A60 Booster Pump Endbell Gasket				
	Letro	LA-40	End Bell Gasket				

GASKET PICTURE GUIDE

<p>G-3001</p> <p>17 7/8" X 8 1/4"</p>	<p>G-3010</p> <p>12 1/4" X 9 11/16"</p>	<p>G-3021</p> <p>10 1/4" X 7 3/8"</p>	<p>G-3030</p> <p>5" X 5"</p>	<p>G-3040</p> <p>13 3/4" X 7 1/2"</p>	<p>G-3101</p> <p>5 1/8" ID X 6 7/16" OD</p>	<p>G-3109</p> <p>5 13/16" ID X 6 15/16" OD</p>	<p>G-3119</p> <p>6 3/8" ID X 7 13/15" OD</p>
<p>G-3002</p> <p>7 3/4" X 7 7/16"</p>	<p>G-3011</p> <p>7" X 7 9/16"</p>	<p>G-3022</p> <p>7 3/8" X 7 3/8"</p>	<p>G-3031</p> <p>8 1/16" X 5 3/4"</p>		<p>G-3102</p> <p>6" ID X 7 1/2" OD</p>	<p>G-3110</p> <p>4 3/4" ID X 5 3/4" OD</p>	<p>G-3120</p> <p>5 1/2" ID X 6 15/16" OD</p>
<p>G-3003</p> <p>7 1/2" X 7 1/8"</p>	<p>G-3012</p> <p>8" X 16 3/8"</p>	<p>G-3023</p> <p>9 15/16" X 7 7/8"</p>	<p>G-3032</p> <p>10 7/16" X 8 1/4"</p>		<p>G-3103</p> <p>6 7/16" ID X 7 3/4" OD</p>	<p>G-3111</p> <p>4 9/16" ID X 6 1/2" OD</p>	<p>G-3121</p> <p>3" ID X 6 3/8" OD</p>
<p>G-3004</p> <p>14 1/2" X 8 1/2"</p>	<p>G-3014</p> <p>10 3/8" X 8 3/8"</p>	<p>G-3024</p> <p>13 1/2" X 9 5/8"</p>	<p>G-3034</p> <p>7 5/8" X 10"</p>		<p>G-3104</p> <p>5 15/16" ID X 6 11/16" OD</p>	<p>G-3112</p> <p>5 3/8" ID X 6 15/16" OD</p>	<p>G-3122</p> <p>5 5/8" ID X 6 3/4" OD</p>
<p>G-3006</p> <p>8" X 8 1/8"</p>	<p>G-3016</p> <p>9 3/4" X 7 11/16"</p>	<p>G-3025</p> <p>4 1/16" X 2 1/4"</p>	<p>G-3035</p> <p>6 7/16" X 4 3/8"</p>		<p>G-3105</p> <p>8 3/8" ID X 10" OD</p>	<p>G-3114</p> <p>6" ID X 6 3/4" OD</p>	<p>G-3123</p> <p>9 5/16" ID X 10 7/8" OD</p>
<p>G-3006K</p>	<p>G-3017</p> <p>9 1/2" X 6 1/2"</p>	<p>G-3026</p> <p>7 1/8" X 7 1/2"</p>	<p>G-3036</p> <p>7 3/4" X 7 1/4"</p>		<p>G-3106</p> <p>9 1/2" ID X 11 1/2" OD</p>	<p>G-3115</p> <p>4 11/16" ID X 5 3/4" OD</p>	<p>G-3124</p> <p>5 15/16" ID X 7 5/8" OD</p>
<p>G-3008</p> <p>17 1/2" X 8 1/8"</p>	<p>G-3018</p> <p>7 7/8" X 7 5/8"</p>	<p>G-3027</p> <p>13 1/8" X 10 1/2"</p>	<p>G-3037</p> <p>8 3/8" X 18 1/8"</p>		<p>G-3107</p> <p>5 3/4" ID X 7" OD</p>	<p>G-3116</p> <p>4 9/16" ID X 7 3/16" OD</p>	<p>G-3125</p> <p>6" ID X 6 3/8" OD</p>
<p>G-3009</p> <p>7" X 7 1/2"</p>	<p>G-3019</p> <p>7 7/8" X 7 11/16"</p>	<p>G-3028</p> <p>6 7/16" X 5 1/2"</p>	<p>G-3038</p> <p>8 1/4" X 10 1/2"</p>		<p>G-3108</p> <p>4 7/16" ID X 6 3/8" OD</p>	<p>G-3117</p> <p>4" ID X 5" OD</p>	<p>G-3126</p> <p>5 3/4" ID X 6 3/4" OD</p>
	<p>G-3020</p> <p>10 1/2" X 8 5/16"</p>	<p>G-3029</p> <p>7 1/2" X 7 1/8"</p>	<p>G-3039</p> <p>9 11/16" X 12 1/4"</p>			<p>G-3118</p> <p>8 1/4" ID X 9 3/4" OD</p>	<p>G-3127</p> <p>5 7/16" ID X 6 7/8" OD</p>

Please Note: Gasket dimensions listed are for identification purposes only













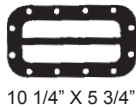















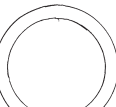









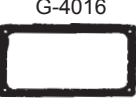











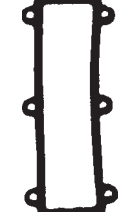
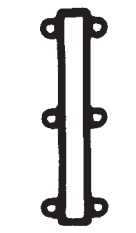

GASKET PICTURE GUIDE

G-3128 6 1/4" ID X 7 1/8" OD	G-3136 4 1/2" ID X 6 7/8" OD	G-3146 5 3/16" ID X 6 1/2" OD	G-3155 5 1/4" ID X 6 3/8" OD	G-3165 10 1/2" ID X 12" OD	G-3174 4 5/16" ID X 5 15/16" OD	G-3184 7/16" ID X 11/16" OD	G-3193 1 5/16" ID X 1 7/8" OD
G-3129 5" ID X 7 3/8" OD	G-3137 2 1/2" ID X 4 1/8" OD	G-3147 1 3/4" ID X 3" OD	G-3157 9 3/4" ID X 11 1/2" OD	G-3166 5 1/4" ID X 6" OD	G-3175 5/8" ID X 7/8" OD	G-3185 3/8" ID X 3/4" OD	G-3194 1/2" ID X 7/8" OD
G-3130 5 9/16" ID X 7 3/8" OD	G-3138 2 7/16" ID X 3 7/16" OD	G-3148 2 1/16" ID X 3 1/4" OD	G-3158 10 1/2" ID X 12 1/4" OD	G-3168 6 7/16" ID X 7 7/8" OD	G-3176 6 1/2" ID X 8" OD	G-3186 1/4" ID X 3/8" OD	G-3195 1 11/16" ID X 2 1/4" OD
G-3131 4 7/8" ID X 6 1/8" OD	G-3139 4 1/2" ID X 6" OD	G-3149 5 15/16" ID X 7 1/2" OD	G-3159 4 11/16" ID X 5 7/8" OD	G-3169 4 3/4" ID X 6" OD	G-3177 4 7/8" ID X 5 15/16" OD	G-3187 2 5/8" ID X 3 7/8" OD	G-3196 1 7/8" ID X 2 1/4" OD
G-3132 5 11/16" ID X 6 15/16" OD	G-3140 5 5/8" ID X 7" OD	G-3150 6" ID X 7 3/4" OD	G-3160 4" ID X 5" OD	G-3170 6 1/2" ID X 7 3/4" OD	G-3178 4 1/2" ID X 5 7/16" OD	G-3188 2 5/8" ID X 3 3/16" OD	G-3197 7/8" ID X 1 3/8" OD
G-3133 5 1/8" ID X 8 3/8" OD	G-3141 6 1/8" ID X 7 5/8" OD	G-3151 6 1/4" ID X 7 7/8" OD	G-3161 4 7/16" ID X 5 7/16" OD	G-3171 5 1/2" ID X 7 1/2" OD	G-3180 4 1/2" ID X 5 3/4" OD	G-3189 6 3/8" ID X 8" OD	G-3198 1/8" ID X 3/8" OD
G-3134 4 13/16" ID X 6" OD	G-3143 8 3/8" ID X 6 3/4" OD	G-3152 3 7/8" ID X 5 1/8" OD	G-3162 5 3/16" ID X 6 7/8" OD	G-3172 4 7/8" ID X 6 1/4" OD	G-3181 3/4" ID X 7/8" OD	G-3190 1 1/2" ID X 2 3/4" OD	G-3199 7/16" ID X 1 3/16" OD
G-3135 4 15/16" ID X 6 1/8" OD	G-3144 3 5/16" ID X 4 5/16" OD	G-3153 5 1/2" ID X 7 1/8" OD	G-3163 10 3/8" ID X 12 1/8" OD	G-3173 2 9/16" ID X 3 7/16" OD	G-3182 1/8" ID X 3/8" OD	G-3191 1 15/16" ID X 2 7/16" OD	G-3202 5 1/8" ID X 6 1/8" OD
	G-3145 1 1/2" ID X 2 13/16" OD	G-3154 2 5/8" ID X 3 13/16" OD	G-3164 7 3/4" ID X 9 3/8" OD		G-3183 6 13/16" ID X 7 1/2" OD	G-3192 1 5/8" ID X 2 1/4" OD	G-3203 6 3/8" X 5 3/4"







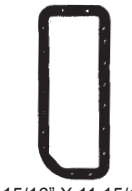











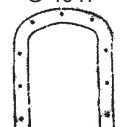
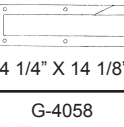





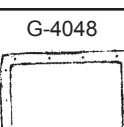
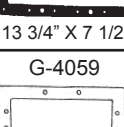

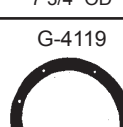

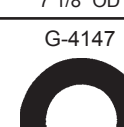

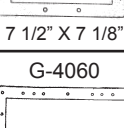











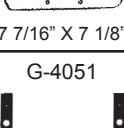
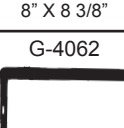



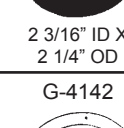

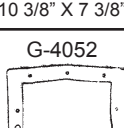

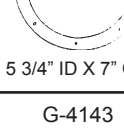
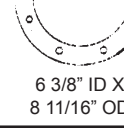
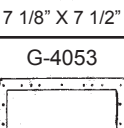
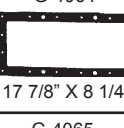

GASKET PICTURE GUIDE

G-3204 6 5/8" X 3 1/8"	G-3215 4 1/2" X 2 1/2"	G-3226 5 9/16" ID X 5 15/16" OD	G-3236 4 1/2" ID X 5 11/16" OD	G-3247 6" ID X 6 13/16" OD	G-3256 4 11/16" ID X 5 3/8" OD	G-3266 4 5/16" X 4 5/16"	G-3281 1 1/8" ID X 1 15/16" OD
G-3205 6" X 5"	G-3216 4 15/16" ID X 6 1/8" OD	G-3228 5 1/2" X 5 1/2"	G-3237 5 1/16" X 6 1/4"	G-3248 5 1/2" X 3 1/8"	G-3257 5 3/16" ID X 6 7/16" OD	G-3268 2" ID X 2 1/2" OD	G-3282 6 1/16" X 5 1/8"
G-3206 3 1/4" X 1 5/8"	G-3217 2 5/8" X 2 5/8"	G-3229 5 1/4" ID X 5 3/8" OD	G-3238 6 1/4" X 4 7/8"	G-3249 4 11/16" ID X 5 7/16" OD	G-3258 6" ID X 6 1/2" OD	G-3269 7 5/8" X 6 1/4"	G-3283 11 3/8" X 8 3/4"
G-3207 3 1/4" X 3 1/4"	G-3218 5 1/8" ID X 5 13/16" OD	G-3230 2 3/4" ID X 3 1/4" OD	G-3239 1/8" ID X 7/16" OD	G-3250 5 1/2" X 4 3/4"	G-3259 5 3/16" ID X 5 3/4" OD	G-3271 2 13/16" X 2 13/16"	G-3284 1 7/8" X 1"
G-3208 4 7/8" X 4 1/2"	G-3219 4" X 4"	G-3231 1/2" ID X 2 3/8" OD	G-3240 4 1/4" X 4 1/4"	G-3251 4 1/2" ID X 5 3/16" OD	G-3261 5 3/8" ID X 5 13/16" OD	G-3273 1 1/4" ID X 1 7/8" OD	
G-3209 5 3/8" X 4 7/16"	G-3220 5 9/16" ID X 6 1/4" OD	G-3232 2" ID X 2 7/16" OD	G-3241 4 1/2" X 4 1/2"	G-3252 3 1/4" X 2 9/16"	G-3262 2 5/8" ID X 3 1/2" OD	G-3274 1 7/8" X 2 3/16"	
G-3210 5 5/8" ID X 5 15/16" OD	G-3222 5 1/4" ID X 5 13/16" OD	G-3233 3 3/4" X 2 15/16"	G-3242 2 5/16" ID X 3 3/8" OD	G-3253 4 7/8" ID X 5 5/8" OD	G-3263 1 7/8" ID X 2 1/4" OD	G-3275 1 3/4" ID X 2 5/8" OD	
G-3211 1 5/8" ID X 3 3/8" OD	G-3224 3 3/16" X 3 3/16"	G-3234 1 7/8" ID X 2 1/4" OD	G-3243 4" X 2 7/8"	G-3254 1 7/8" ID X 2 3/8" OD	G-3264 3/4" ID X 1" OD	G-3277 1 1/8" ID X 2" OD	
G-3212 4" ID X 6 5/8" OD	G-3225 2 3/4" ID X 3 5/16" OD	G-3235 1 11/16" ID X 2 3/16" OD	G-3244 3 5/8" X 1 3/4"	G-3255 4 1/8" X 3 1/2"	G-3265 4" X 4"	G-3278 2 1/4" ID X 5" OD	
G-3214 6 1/4" X 5 3/4"			G-3246 2 1/2" ID X 3 1/8" OD			G-3280 3/8" ID X 13/16" OD	

GASKET PICTURE GUIDE

<p>G-3400</p>  <p>6 9/16" ID X 7 7/8" OD</p>	<p>G-3409</p>  <p>7/8" ID X 1 1/4" OD</p>	<p>G-4001</p>  <p>8 1/8" X 7 3/4"</p>	<p>G-4011</p>  <p>10 1/4" X 5 3/4"</p>	<p>G-4020</p>  <p>23 3/4" X 3 1/2"</p>	<p>G-4027</p>  <p>9 7/16" X 5 3/4"</p>	<p>G-4036</p>  <p>7 1/16" X 7 3/8"</p>
<p>G-3401</p>  <p>7 5/16" ID X 9 3/8" OD</p>	<p>G-3410</p>  <p>4 1/2" ID X 6 7/8" OD</p>	<p>G-4002</p>  <p>7 7/8" X 7 7/8"</p>	<p>G-4012</p>  <p>7 1/2" X 10"</p>	<p>G-4021</p>  <p>3 3/4" X 14 1/2"</p>	<p>G-4029</p>  <p>9 1/2" X 7 1/4"</p>	<p>G-4037</p>  <p>3" X 6 3/8"</p>
<p>G-3402</p>  <p>5 15/16" ID X 7" OD</p>	<p>G-3411</p>  <p>6 5/8" ID X 8 3/4" OD</p>	<p>G-4003</p>  <p>13 3/8" X 7"</p>	<p>G-4014</p>  <p>9 1/2" X 8 3/8"</p>		<p>G-4029A</p>  <p>7 1/2" X 9 15/16"</p>	<p>G-4038</p>  <p>1" X 1"</p>
<p>G-3403</p>  <p>1 7/8" ID X 2 3/8" OD</p>	<p>G-3412</p>  <p>6 5/8" ID X 7 5/8" OD</p>	<p>G-4004</p>  <p>13 1/4" X 6 13/16"</p>	<p>G-4015</p>  <p>8 13/16" X 7 3/8"</p>	<p>G-4023</p>  <p>5 7/8" X 10 3/8"</p>	<p>G-4030</p>  <p>9 5/8" X 7 5/16"</p>	<p>G-4040</p>  <p>6 3/4" X 6 3/8"</p>
<p>G-3404</p>  <p>9 1/2" ID X 10" OD</p>	<p>G-3414</p>  <p>9 1/4" ID X 11 1/4" OD</p>	<p>G-4005</p>  <p>5 3/16" X 2 3/8"</p>	<p>G-4016</p>  <p>6 1/2" X 3 3/8"</p>		<p>G-4031</p>  <p>8 3/4" X 7 3/8"</p>	<p>G-4041</p>  <p>7 13/16" X 7 3/8"</p>
<p>G-3405</p>  <p>7/8" ID X 1 1/4" OD</p>	<p>G-3415</p>  <p>14 1/2" ID X 16 1/2" OD</p>	<p>G-4006</p>  <p>5 1/4" X 3"</p>	<p>G-4017</p>  <p>3 1/4" X 12"</p>	<p>G-4024</p>  <p>3 7/16" X 12"</p>	<p>G-4032</p>  <p>10 5/8" X 8 1/8"</p>	<p>G-4042</p>  <p>10 5/8" X 10 1/2"</p>
<p>G-3406</p>  <p>2 5/16" ID X 2 5/8" OD</p>	<p>G-3416</p>  <p>6 1/2" ID X 7 3/4" OD</p>	<p>G-4007</p>  <p>13 1/16" X 4"</p>	<p>G-4018</p>  <p>13" X 1 7/8"</p>		<p>G-4033</p>  <p>4 1/4" X 4 1/4"</p>	<p>G-4043</p>  <p>10" X 10"</p>
<p>G-3407</p>  <p>1 7/8" ID X 2 3/16" OD</p>	<p>Please Note: Gasket dimensions listed are for identification purposes only</p>	<p>G-4008</p>  <p>7 1/2" X 10"</p>	<p>G-4019</p>  <p>7" X 2 7/8"</p>	<p>G-4025</p>  <p>8 7/16" X 3 5/8"</p>	<p>G-4034</p>  <p>10 1/2" X 13"</p>	<p>G-4044</p>  <p>5" X 11 7/8"</p>
<p>G-3408</p>  <p>3/8" ID X 1 3/16" OD</p>		<p>G-4026</p>  <p>9 7/8" X 9 7/8"</p>	<p>G-4035</p>  <p>2 1/4" X 10"</p>	<p>G-4045</p>  <p>4 15/16" X 11 15/16"</p>		

GASKET PICTURE GUIDE

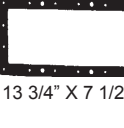
<p>G-4046</p>  <p>3 5/8" X 3 5/8"</p>	<p>G-4055</p>  <p>8 3/8" X 8 5/16"</p>	<p>G-4067</p>  <p>7 1/2" X 5 1/2"</p>	<p>G-4102</p>  <p>7 1/4" ID X 8 7/8" OD</p>	<p>G-4115</p>  <p>4 1/4" ID X 5 1/8" OD</p>	<p>G-4128</p>  <p>2 15/16" ID X 3 15/16" OD</p>	<p>G-4137</p>  <p>4" ID X 5 1/8" OD</p>	<p>G-4145</p>  <p>9 1/4" ID X 10 1/2" OD</p>
<p>G-4047</p>  <p>6 3/4" X 4 3/8"</p>	<p>G-4056</p>  <p>4 1/4" X 14 1/8"</p>		<p>G-4103</p>  <p>2 11/16" ID X 3 11/16" OD</p>	<p>G-4116</p>  <p>6 5/8" ID X 7 3/4" OD</p>	<p>G-4129</p>  <p>2 1/2" ID X 4 7/16" OD</p>	<p>G-4138</p>  <p>3 1/8" ID X 4 11/16" OD</p>	<p>G-4146</p>  <p>4 7/16" ID X 7 1/8" OD</p>
<p>G-4048</p>  <p>13 3/8" X 9 3/4"</p>	<p>G-4058</p>  <p>13 3/4" X 7 1/2"</p>		<p>G-4104</p>  <p>4 1/2" ID X 5 3/4" OD</p>	<p>G-4119</p>  <p>6 1/4" X 6 1/8"</p>	<p>G-4130</p>  <p>5 3/4" ID X 6 5/8" OD</p>	<p>G-4139</p>  <p>2 3/8" OD</p>	<p>G-4147</p>  <p>7" ID X 8 3/16" OD</p>
<p>G-4049</p>  <p>8 1/2" X 11 1/4"</p>	<p>G-4059</p>  <p>7 1/2" X 7 1/8"</p>		<p>G-4105</p>  <p>5 9/16" ID X 7 15/16" OD</p>	<p>G-4120</p>  <p>5" X 5"</p>	<p>G-4131</p>  <p>1 7/8" ID X 3 1/4" OD</p>	<p>G-4140</p>  <p>3 1/4" ID X 4 3/16" OD</p>	<p>G-4148</p>  <p>8 1/4" ID X 9 7/8" OD</p>
<p>G-4050</p>  <p>7 7/16" X 7 1/8"</p>	<p>G-4060</p>  <p>7 1/2" X 13 1/2"</p>		<p>G-4110</p>  <p>2 1/2" ID X 3 3/8" OD</p>	<p>G-4121</p>  <p>1 15/16" ID X 2 7/8" OD</p>	<p>G-4132</p>  <p>1 11/16" ID X 3 1/2" OD</p>	<p>G-4141</p>  <p>2 3/16" ID X 2 1/4" OD</p>	<p>G-4149</p>  <p>3 9/16" ID X 5 1/8" OD</p>
<p>G-4051</p>  <p>10 3/8" X 7 3/8"</p>	<p>G-4062</p>  <p>12 1/2" X 8 3/16"</p>		<p>G-4111</p>  <p>4 13/16" ID X 6" OD</p>	<p>G-4122</p>  <p>1 1/4" ID X 3 1/8" OD</p>	<p>G-4133</p>  <p>1 1/4" ID X 3 1/8" OD</p>	<p>G-4142</p>  <p>5 3/4" ID X 7" OD</p>	<p>G-4150</p>  <p>6 3/8" ID X 8 11/16" OD</p>
<p>G-4052</p>  <p>7 1/8" X 7 1/2"</p>	<p>G-4063</p>  <p>6 3/16" X 4 1/4"</p>		<p>G-4112</p>  <p>5 9/16" ID X 10" OD</p>	<p>G-4123</p>  <p>2 1/8" ID X 3 1/4" OD</p>	<p>G-4134</p>  <p>2 1/8" ID X 3 1/4" OD</p>	<p>G-4143</p>  <p>3 9/16" ID X 4 15/16" OD</p>	<p>G-4151</p>  <p>5 7/8" ID X 7 1/16" OD</p>
<p>G-4053</p>  <p>7 3/4" X 13 7/8"</p>	<p>G-4064</p>  <p>17 7/8" X 8 1/4"</p>		<p>G-4113</p>  <p>3 3/8" ID X 4 1/2" OD</p>	<p>G-4124</p>  <p>1 3/4" ID X 3 3/8" OD</p>	<p>G-4135</p>  <p>6 3/4" ID X 8 13/16" OD</p>	<p>G-4144</p>  <p>3 5/8" ID X 5 3/4" OD</p>	<p>G-4152</p>  <p>6" ID X 7 1/16" OD</p>
<p>G-4054</p>  <p>7 1/2" X 14 13/16"</p>	<p>G-4065</p>  <p>10 1/2" X 8 5/16"</p>		<p>G-4114</p>  <p>1 1/2" ID X 4" OD</p>	<p>G-4125</p>  <p>2 1/2" ID X 3 1/2" OD</p>			
	<p>G-4066</p>  <p>13 3/4" X 7 1/2"</p>						



















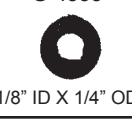





















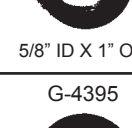







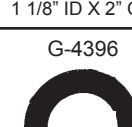
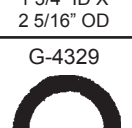

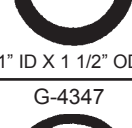

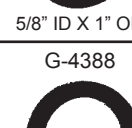
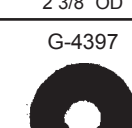

GASKET PICTURE GUIDE

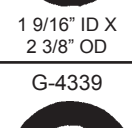
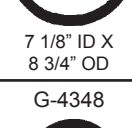
<p>G-4153</p> <p>3" ID X 4 1/4" OD</p>	<p>G-4162</p> <p>14 3/8" ID X 16 1/8" OD</p>		<p>G-4201</p> <p>2" ID X 2 3/8" OD</p>	<p>G-4210</p> <p>1 3/16" ID X 1 5/8" OD</p>	<p>G-4219</p> <p>1 13/16" ID X 2 7/16" OD</p>	<p>G-4227</p> <p>3/4" ID X 1 5/8" OD</p>	<p>G-4237</p> <p>2 5/8" ID X 3 1/2" OD</p>
<p>G-4154</p> <p>4 5/16" ID X 5 7/8" OD</p>	<p>G-4163</p> <p>5 3/4" ID X 7 3/16" OD</p>		<p>G-4202</p> <p>2 1/8" ID X 3 9/16" OD</p>	<p>G-4211</p> <p>2 1/4" ID X 3" OD</p>	<p>G-4220</p> <p>1 7/8" ID X 3 1/4" OD</p>	<p>G-4228</p> <p>1 11/16" ID X 2 1/4" OD</p>	<p>G-4238</p> <p>2" ID X 3 1/8" OD</p>
<p>G-4155</p> <p>6 5/16" ID X 8 3/8" OD</p>	<p>G-4164</p> <p>5 1/8" ID X 6 1/2" OD</p>		<p>G-4203</p> <p>15/16" X 1 5/16" OD</p>	<p>G-4212</p> <p>5/8" ID X 1 3/8" OD</p>	<p>G-4221</p> <p>1/4" ID X 1/2" OD</p>	<p>G-4229</p> <p>1 11/16" ID X 2 3/8" OD</p>	<p>G-4239</p> <p>1 1/4" ID X 2 3/8" OD</p>
<p>G-4156</p> <p>6 1/4" ID X 8 11/16" OD</p>	<p>G-4165</p> <p>10 1/2" ID X 12 1/4" OD</p>		<p>G-4204</p> <p>1 7/8" ID X 2 1/2" OD</p>	<p>G-4214</p> <p>15/16" ID X 1 1/4" OD</p>	<p>G-4222</p> <p>3" ID X 3 11/16" OD</p>	<p>G-4230</p> <p>1 5/8" ID X 2 1/8" OD</p>	<p>G-4240</p> <p>1 5/16" ID X 2" OD</p>
<p>G-4157</p> <p>4 7/16" ID X 7 1/8" OD</p>	<p>G-4186</p> <p>5" ID X 6 1/8" OD</p>		<p>G-4205</p> <p>1" ID X 1 5/16" OD</p>	<p>G-4215</p> <p>1 1/16" ID X 1 13/16" OD</p>	<p>G-4223</p> <p>3 3/16" ID X 3 3/4" OD</p>	<p>G-4231</p> <p>9/16" ID X 1" OD</p>	<p>G-4241</p> <p>3 1/2" ID X 4 3/8" OD</p>
<p>G-4158</p> <p>6 7/8" ID X 8 3/4" OD</p>			<p>G-4206</p> <p>1/2" ID X 1 1/4" OD</p>	<p>G-4216</p> <p>2 1/16" ID X 3" OD</p>	<p>G-4224</p> <p>3/4" ID X 1 3/16" OD</p>	<p>G-4232</p> <p>1 3/16" ID X 1 7/16" OD</p>	<p>G-4242</p> <p>1 5/16" ID X 2 1/4" OD</p>
<p>G-4159</p> <p>10 1/2" ID X 12" OD</p>			<p>G-4207</p> <p>2" ID X 3" OD</p>	<p>G-4217</p> <p>13 1/2" X 10 3/8"</p>	<p>G-4225</p> <p>9/16" ID X 13/16" OD</p>	<p>G-4233</p> <p>3 3/16" ID X 4 3/16" OD</p>	<p>G-4243</p> <p>2 11/16" ID X 3 1/2" OD</p>
<p>G-4160</p> <p>1 9/16" ID X 2 1/4" OD</p>			<p>G-4208</p> <p>1/8" ID X 3/4" OD</p>	<p>G-4218</p> <p>6 3/4" ID X 7 13/16" OD</p>	<p>G-4226</p> <p>1 1/16" ID X 1 3/8" OD</p>	<p>G-4234</p> <p>5" ID X 5 1/2" OD</p>	<p>G-4244</p> <p>2 1/2" ID X 3 1/2" OD</p>

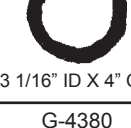
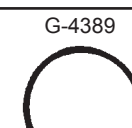

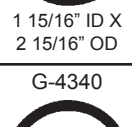

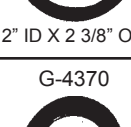
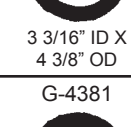

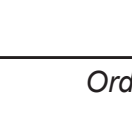
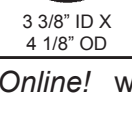
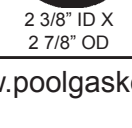
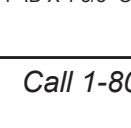
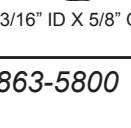



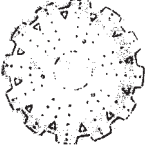













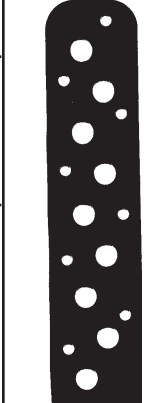



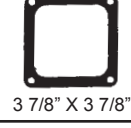
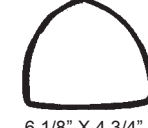



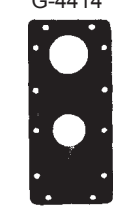





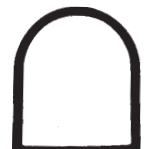

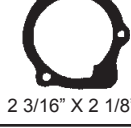

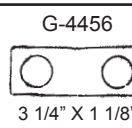
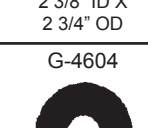











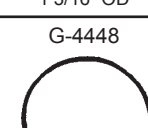

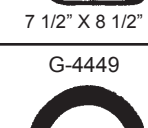

GASKET PICTURE GUIDE

G-4245 1 13/16" ID X 2 9/16" OD	G-4253 9/16" ID X 1 1/4" OD	G-4261 1 5/8" ID X 2 3/16" OD	G-4270 5 7/8" ID X 7 3/16" OD	G-4279 1" ID X 2" OD	G-4287 2" ID X 2 7/8" OD	G-4297 1/16" ID X 5/16" OD	G-4310 2" ID X 2 1/2" OD
G-4246 2 1/8" ID X 2 5/8" OD	G-4254 5/8" ID X 1 1/2" OD	G-4262 15/16" ID X 1 1/8" OD	G-4271 3" ID X 3 1/2" OD	G-4280 5/8" ID X 1" OD	G-4288 2" ID X 2 3/8" OD	G-4298 1 1/4" ID X 2" OD	G-4311 1 15/16" ID X 3 1/2" OD
G-4247 2 1/16" ID X 3 9/16" OD	G-4255 3/4" ID X 1 1/4" OD	G-4263 3/8" ID X 1 1/8" OD	G-4272 4 1/2" ID X 5 1/2" OD	G-4281 9/16" ID X 13/16" OD	G-4290 2 7/16" ID X 3 3/8" OD	G-4299 2 5/8" ID X 3 3/8" OD	G-4312 3/16" ID X 9/16" OD
G-4248 4" ID X 4 9/16" OD	G-4256 13/16" ID 1 3/4" OD	G-4264 10 1/4" ID X 11 1/8" OD	G-4273 4 1/8" ID X 5" OD	G-4282 1 3/8" ID X 2 1/4" OD	G-4291 2" ID X 3" OD	G-4300 7/8" ID X 1 1/4" OD	G-4314 3/4" ID X 1 1/4" OD
G-4249 2 1/16" ID X 2 15/16" OD	G-4257 2 5/16" ID X 3 1/4" OD	G-4265 1 15/16" ID X 3" OD	G-4274 7 7/8" ID X 8 3/4" OD	G-4283 7 7/8" ID X 9 3/8" OD	G-4292 1 1/4" ID X 1 5/8" OD	G-4303 3/4" ID X 1 1/4" OD	G-4315 1" ID X 1 1/2" OD
G-4250 1 3/8" ID X 1 13/16" OD	G-4258 1/2" ID X 1 13/16" OD	G-4266 1 3/4" ID X 2 1/2" OD	G-4275 3/16" ID X 9/16" OD	G-4284 1 9/16" ID X 1 15/16" OD	G-4294 2 1/4" ID X 2 11/16" OD	G-4304 2 1/4" ID X 3 3/8" OD	G-4316 1" ID X 1 1/2" OD
G-4251 5/16" ID X 1" OD	G-4259 2 1/2" ID X 3 7/16" OD	G-4267 1/2" ID X 3/4" OD	G-4276 3" ID X 3 3/8" OD	G-4285 5/8" ID X 1 1/4" OD	G-4295 1" ID X 1 1/2" OD	G-4305 13/16" ID X 1 7/16" OD	G-4319 5/8" ID X 1" OD
G-4252 13/16" ID X 2 1/16" OD	G-4260 1 9/16" ID X 2 9/16" OD	G-4268 2 1/2" ID X 3" OD	G-4277 6" ID X 6 1/2" OD	G-4286 3" ID X 4 1/16" OD	G-4296 1 7/8" ID X 2 3/4" OD	G-4306 2" ID X 2 3/8" OD	G-4320 3/4" ID X 1 1/8" OD
	G-4269 5 3/16" ID X 6 1/16" OD	G-4278 2 9/16" ID X 3 7/16" OD				G-4309 1 1/4" ID X 1 3/4" OD	G-4322 1 3/16" ID X 2" OD

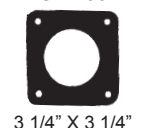
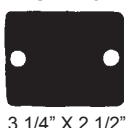















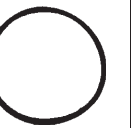







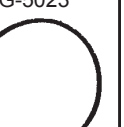



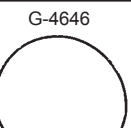

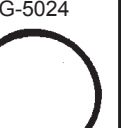







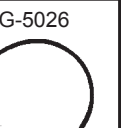











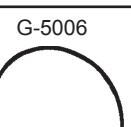

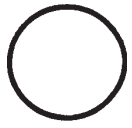
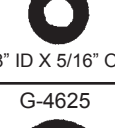

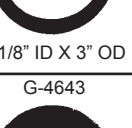
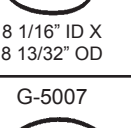

GASKET PICTURE GUIDE

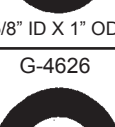
G-4323  1 11/16" ID X 2 1/4" OD	G-4332  3 1/4" ID X 3 7/8" OD	G-4341  2 3/8" ID X 3" OD	G-4350  2 1/4" ID X 2 15/16" OD	G-4359  2 1/8" ID X 3" OD	G-4371  2 3/4" ID X 3 1/2" OD	G-4382  6 3/4" ID X 8 1/8" OD	G-4391  3 1/16" ID X 4 3/8" OD
G-4324  2 3/8" ID X 3 1/16" OD	G-4333  1/8" ID X 1/4" OD	G-4342  7/16" ID X 1 11/16" OD	G-4352  2 5/8" ID X 3 3/8" OD	G-4360  1 11/16" ID X 2 7/16" OD	G-4373  1 13/16" ID X 3 5/16" OD	G-4383  1/2" ID X 3/4" OD	G-4392  2 3/16" ID X 2 13/16" OD
G-4325  1/2" ID X 15/16" OD	G-4334  1/2" ID X 2" OD	G-4343  2 1/2" ID X 3 1/16" OD	G-4353  1 9/16" ID X 2 1/4" OD	G-4361  1 1/8" ID X 2" OD	G-4374  1 11/16" ID X 2 1/8" OD	G-4384  5 1/16" ID X 6 1/8" OD	G-4393  1/2" ID X 1" OD
G-4326  3/4" ID X 1 1/4" OD	G-4335  1 3/16" ID X 1 11/16" OD	G-4344  1/4" ID X 5/8" OD	G-4354  2 1/2" ID X 3 3/16" OD	G-4362  5/8" ID X 1" OD	G-4375  2 3/8" ID X 2 15/16" OD	G-4385  5/8" ID X 1" OD	G-4394  1 1/8" ID X 2" OD
G-4327  3/8" ID X 3/4" OD	G-4336  2 3/8" ID X 3 5/8" OD	G-4345  5 9/16" ID X 5 13/16" OD	G-4355  2 7/16" ID X 3 1/8" OD	G-4363  1 3/4" ID X 2 1/4" OD	G-4376  15/16" ID X 1 5/16" OD	G-4386  1/2" ID X 3/4" OD	G-4395  1 1/2" ID X 2 3/8" OD
G-4328  1 3/4" ID X 2 5/16" OD	G-4337  2" ID X 2 7/8" OD	G-4346  1" ID X 1 1/2" OD	G-4356  3 1/2" ID X 4 3/8" OD	G-4364  2 5/16" ID X 2 7/8" OD	G-4377  2 13/16" ID X 3 11/16" OD	G-4387  1" ID X 1 1/4" OD	G-4396  3/16" ID X 5/16" OD
G-4329  3/4" ID X 1 1/8" OD	G-4338  1 9/16" ID X 2 3/8" OD	G-4347  7 1/8" ID X 8 3/4" OD	G-4357  1 1/2" ID X 1 7/8" OD	G-4366  1 5/8" ID X 2 1/4" OD	G-4378  3 1/16" ID X 4" OD	G-4388  12" ID X 13 3/8" OD	G-4397  3/4" ID X 1 1/8" OD
G-4330  3/4" ID X 1 1/16" OD	G-4339  1 15/16" ID X 2 15/16" OD	G-4348  1 1/16" ID X 1 7/8" OD	G-4358  1 1/2" ID X 2 5/16" OD	G-4369  2" ID X 2 3/8" OD	G-4380  3 3/16" ID X 4 3/8" OD	G-4389  5 3/4" ID X 6 7/8" OD	G-4398  2 3/4" ID X 3 1/4" OD
G-4331  1 1/4" ID X 1 7/16" OD	G-4340  3 3/8" ID X 4 1/8" OD	G-4349  2 3/8" ID X 2 7/8" OD		G-4370  1" ID X 1 5/8" OD	G-4381  3/16" ID X 5/8" OD		

GASKET PICTURE GUIDE

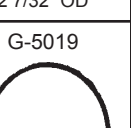



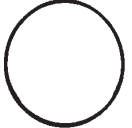













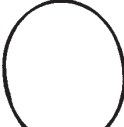
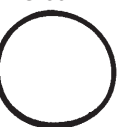

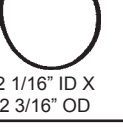

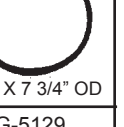



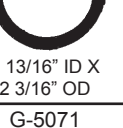

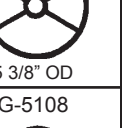
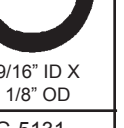



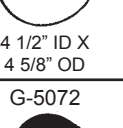

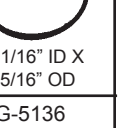







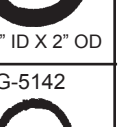

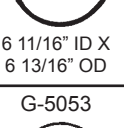



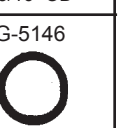

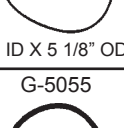







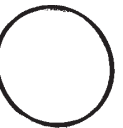

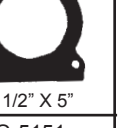

G-4401  4" ID X 14 3/4" OD	G-4410  3 1/4" X 3 1/4"	G-4420  8 1/8" X 3 1/8"	G-4431  5 1/4" X 3"	G-4442  1 1/8" X 3/4"	G-4452  8 1/2" X 3 5/8"	G-4462  9/16" OD	G-4600  3/8" ID X 3/4" OD
G-4402  2 7/16" ID X 16 1/2" OD	G-4411  4 1/2" X 4 1/2"	G-4421  1 1/4" OD	G-4432  3 11/16" X 2 9/16"	G-4443  1 3/16" OD	G-4453  3 3/8" X 6 5/16"	G-4463  14 3/8" X 3 1/4"	G-4601  1/2" ID X 1 9/16" OD
G-4403  3 7/16" ID X 16 5/8" OD	G-4412  6 1/4" X 5 5/8"	G-4422  2 5/8" X 1 7/8"	G-4433  3 7/8" X 3 7/8"	G-4444  6 1/8" X 4 3/4"	G-4454  2 9/16" X 2 1/2"		G-4602  2 13/16" ID X 3 1/4" OD
G-4404  3 1/2" ID X 18 1/2" OD	G-4414  8 1/8" X 3 3/4"	G-4423  3 15/16" X 3"	G-4434  4" X 4"	G-4445  2" OD	G-4455  3 7/16" X 2 7/16"		G-4603  2 3/8" ID X 2 3/4" OD
G-4405  6 1/8" X 7 3/16"	G-4415  1 1/2" OD	G-4424  1 1/2" OD	G-4435  2 3/16" X 2 1/8"	G-4446  1/8" OD	G-4456  3 1/4" X 1 1/8"		G-4604  1/4" ID X 13/16" OD
G-4406  5" OD	G-4416  3 5/8" X 3 5/8"	G-4425  1 3/16" OD	G-4436  4 1/4" X 4 1/4"	G-4447  1 3/16" OD	G-4457  3 11/16" X 3 1/2"		G-4605  7/8" ID X 1 1/8" OD
G-4407  5 5/8" X 4 1/4"	G-4417  7/16" ID X 1 1/4" OD	G-4426  3 1/4" OD	G-4437  1 1/2" X 1 1/2"	G-4448  7 1/2" X 8 1/2"	G-4458  1 5/8" OD		G-4606  2 1/2" ID X 3 3/16" OD
G-4408  4 13/16" X 2 5/8"	G-4418  1 1/4" OD	G-4427  7 3/4" OD	G-4438  5" X 3 1/16"	G-4449  1 5/8" ID X 2 3/8" OD	G-4459  1 3/16" OD		G-4607  1 5/8" ID X 2 3/16" OD
G-4409  3 1/4" X 3 1/4"	G-4419  3 1/4" X 2 1/2"	G-4428  1/4" ID X 3/4" OD	G-4440  5 7/8" X 7 7/8"	G-4450  4" X 4"	G-4460  3/4" OD		G-4608  3" ID X 4" OD

GASKET PICTURE GUIDE

G-4609  5 3/4" ID X 7 1/8" OD	G-4618  5/8" ID X 1" OD	G-4627  2 1/8" ID X 2 7/8" OD	G-4636  4 9/16" ID X 5 11/16" OD	G-4644  2 1/8" ID X 3" OD	G-5001  1" ID X 1 5/16" OD	G-5009  5 1/2" ID X 5 3/4" OD	G-5022  1 3/16" ID X 1 3/8" OD
G-4610  1/2" ID X 11/16" OD	G-4619  5/8" ID X 1" OD	G-4628  3 3/4" ID X 4 1/2" OD	G-4637  5/8" ID X 1" OD	G-4645  1/2" ID X 3/4" OD	G-5002  1 1/16" ID X 1 7/16" OD	G-5010  3 3/4" ID X 4 1/16" OD	G-5023  5 5/8" ID X 6 1/16" OD
G-4611  13/16" ID X 1 9/16" OD	G-4620  1 1/4" ID X 1 5/8" OD	G-4629  1/2" ID X 1 1/8" OD	G-4638  2 5/16" ID X 3 3/8" OD	G-4646  9" ID X 9 1/4" OD	G-5003  1 15/16" ID X 2 3/8" OD	G-5011  6 1/2" ID X 6 7/8" OD	G-5024  9 5/16" ID X 9 13/16" OD
G-4612  1 15/16" ID X 2 5/8" OD	G-4621  2 1/16" ID X 3" OD	G-4630  5/8" ID X 1" OD	G-4639  2 1/8" ID X 3" OD	G-4647  3 3/4" X 3 1/4"	G-5004  13/16" ID X 1 1/32" OD	G-5012  6 1/2" ID X 7 1/16" OD	G-5026  4 3/4" ID X 5" OD
G-4613  1 15/16" ID X 3 1/8" OD	G-4622  1 13/16" ID X 2 1/8" OD	G-4631  3/8" ID X 3/4" OD	G-4640  1" ID X 1 1/2" OD		G-5005  3/32" ID X 1 1/32" OD	G-5014  4 13/16" ID X 5 1/8" OD	G-5027  9 15/16" ID X 10 7/16" OD
G-4614  3 5/8" ID X 6" OD	G-4623  2 1/4" ID X 3 5/16" OD	G-4632  3/8" ID X 3/4" OD	G-4641  6" ID X 6 3/8" OD		G-5006  8 1/16" ID X 8 13/32" OD	G-5016  6 1/2" ID X 6 3/4" OD	G-5028  2" ID X 2 1/4" OD
G-4615  4 1/4" ID X 4 5/8" OD	G-4624  1/8" ID X 5 1/16" OD	G-4633  1/2" ID X 3/4" OD	G-4642  2 1/8" ID X 3" OD		G-5007  6" ID X 6 3/8" OD	G-5017  1 13/16" ID X 2 7/32" OD	G-5031  2 3/4" ID X 3" OD
G-4616  1/8" ID X 5 1/16" OD	G-4625  5/8" ID X 1" OD	G-4634  3 1/8" ID X 3 7/8" OD	G-4643  1 1/2" ID X 2 5/16" OD		G-5008  4 15/16" ID X 5 15/32" OD	G-5019  4 1/16" ID X 4 3/16" OD	G-5033  2" ID X 2 5/16" OD
G-4617  9/16" ID X 1" OD	G-4626  2" ID X 3" OD	G-4635  2 7/8" ID X 3 3/16" OD					

Please Note: Gasket dimensions listed are for identification purposes only

GASKET PICTURE GUIDE

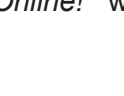
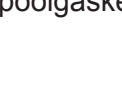
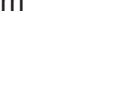
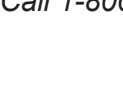
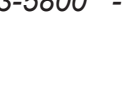
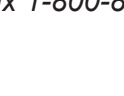
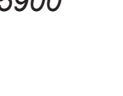
<p>G-5034</p>  <p>1 3/4" ID X 2 3/16" OD</p>	<p>G-5046</p>  <p>2 7/8" ID X 3 1/8" OD</p>	<p>G-5057</p>  <p>1 15/16" ID X 2 11/16" OD</p>	<p>G-5066</p>  <p>3/8" ID X 5/8" OD</p>	<p>G-5078</p>  <p>6 1/4" ID X 6 7/8" OD</p>	<p>G-5104</p>  <p>6 1/16" OD</p>	<p>G-5124</p>  <p>6 1/8" ID X 7 1/2" OD</p>	<p>G-5152</p>  <p>12 1/4" ID X 15" OD</p>
<p>G-5035</p>  <p>6 1/8" ID X 6 7/16" OD</p>	<p>G-5047</p>  <p>2 3/4" ID X 3" OD</p>	<p>G-5058</p>  <p>2 1/16" ID X 2 3/8" OD</p>	<p>G-5067</p>  <p>2 1/16" ID X 2 3/16" OD</p>	<p>G-5079</p>  <p>8 3/4" ID X 9 3/16" OD</p>	<p>G-5105</p>  <p>6 1/16" OD</p>	<p>G-5126</p>  <p>7" ID X 7 3/4" OD</p>	<p>G-5153</p>  <p>9 7/8" ID X 14" OD</p>
<p>G-5036</p>  <p>2 3/16" ID X 2 13/16" OD</p>	<p>G-5048</p>  <p>3/4" ID X 1 5/16" OD</p>	<p>G-5060</p>  <p>6 1/8" ID X 6 3/8" OD</p>	<p>G-5069</p>  <p>1 13/16" ID X 2 3/16" OD</p>	<p>G-5071</p>  <p>4 1/2" ID X 4 5/8" OD</p>	<p>G-5106</p>  <p>5 3/8" OD</p>	<p>G-5129</p>  <p>1 9/16" ID X 2 1/8" OD</p>	<p>G-5154</p>  <p>9 7/8" ID X 14" OD</p>
<p>G-5039</p>  <p>4 5/16" ID X 4 5/8" OD</p>	<p>G-5050</p>  <p>7/16" ID X 3/4" OD</p>	<p>G-5061</p>  <p>10 1/4" ID X 10 3/4" OD</p>	<p>G-5072</p>  <p>1/4" ID X 1/2" OD</p>	<p>G-5073</p>  <p>2 3/16" ID X 2 7/16" OD</p>	<p>G-5108</p>  <p>5 3/8" OD</p>	<p>G-5131</p>  <p>2 11/16" ID X 3 5/16" OD</p>	<p>G-5155</p>  <p>9 7/8" ID X 14" OD</p>
<p>G-5040</p>  <p>2 3/16" ID X 2 7/16" OD</p>	<p>G-5051</p>  <p>3/8" ID X 5/8" OD</p>	<p>G-5062</p>  <p>5 3/4" ID X 6 1/8" OD</p>	<p>G-5074</p>  <p>1 1/2" ID X 1 13/16" OD</p>	<p>G-5075</p>  <p>1/2" ID X 11/16" OD</p>	<p>G-5111</p>  <p>5/8" ID X 1 5/8" OD</p>	<p>G-5136</p>  <p>1 1/2" ID X 2" OD</p>	<p>G-5156</p>  <p>9 7/8" ID X 14" OD</p>
<p>G-5041</p>  <p>1 3/4" ID X 2 3/4" OD</p>	<p>G-5052</p>  <p>6 11/16" ID X 6 13/16" OD</p>	<p>G-5063</p>  <p>3/4" ID X 1 5/16" OD</p>	<p>G-5076</p>  <p>6 1/8" ID X 6 3/8" OD</p>	<p>G-5077</p>  <p>5" ID X 5 1/2" OD</p>	<p>G-5112</p>  <p>3/8" ID X 1 11/16" OD</p>	<p>G-5142</p>  <p>11/16" ID X 13/16" OD</p>	<p>G-5157</p>  <p>9 7/8" ID X 14" OD</p>
<p>G-5043</p>  <p>5/8" ID X 1 1/16" OD</p>	<p>G-5053</p>  <p>5" ID X 5 1/8" OD</p>	<p>G-5064</p>  <p>1 1/4" ID X 2 7/16" OD</p>	<p>G-5078</p>  <p>6 1/4" ID X 6 7/8" OD</p>	<p>G-5079</p>  <p>8 3/4" ID X 9 3/16" OD</p>	<p>G-5114</p>  <p>3/8" ID X 2" OD</p>	<p>G-5146</p>  <p>9/16" ID X 3/4" OD</p>	<p>G-5158</p>  <p>9 7/8" ID X 14" OD</p>
<p>G-5045</p>  <p>7 3/16" ID X 7 7/16" OD</p>	<p>G-5055</p>  <p>6 3/16" ID X 6 9/16" OD</p>	<p>G-5065</p>  <p>2 3/4" ID X 2 7/8" OD</p>	<p>G-5079</p>  <p>8 3/4" ID X 9 3/16" OD</p>	<p>G-5080</p>  <p>8 3/4" ID X 9 3/16" OD</p>	<p>G-5117</p>  <p>7/16" ID X 1 9/16" OD</p>	<p>G-5149</p>  <p>2 1/2" OD</p>	<p>G-5159</p>  <p>9 7/8" ID X 14" OD</p>
<p>G-5046</p>  <p>2 7/8" ID X 3 1/8" OD</p>	<p>G-5057</p>  <p>1 15/16" ID X 2 11/16" OD</p>	<p>G-5066</p>  <p>3/8" ID X 5/8" OD</p>	<p>G-5077</p>  <p>5" ID X 5 1/2" OD</p>	<p>G-5078</p>  <p>6 1/4" ID X 6 7/8" OD</p>	<p>G-5119</p>  <p>6 3/4" OD</p>	<p>G-5150</p>  <p>4 1/2" X 5"</p>	<p>G-5160</p>  <p>9 7/8" ID X 14" OD</p>
<p>G-5047</p>  <p>2 3/4" ID X 3" OD</p>	<p>G-5058</p>  <p>2 1/16" ID X 2 3/8" OD</p>	<p>G-5067</p>  <p>2 1/16" ID X 2 3/16" OD</p>	<p>G-5078</p>  <p>6 1/4" ID X 6 7/8" OD</p>	<p>G-5079</p>  <p>8 3/4" ID X 9 3/16" OD</p>	<p>G-5120</p>  <p>6 3/4" OD</p>	<p>G-5151</p>  <p>1 5/8" ID X 2 3/16" OD</p>	<p>G-5161</p>  <p>9 7/8" ID X 14" OD</p>

REPLACEMENT PUMP SEALS



TYPE: A



TYPE: B



TYPE: C

<p>MS-100 TYPE: A SHAFT DIA.: 5/8" Anthony 04547 Baker Hydro MI-29-3 Purex (Eastside) P-28280 Sears 42G2377W Model 390, 154, 3/HP Sta Rite U109-93SS For Dura Glass, AJ Series, Maxi Glas (Before 1998), PLBC Series; U9-6, A, C, D, F, G, H Series; P2RA 1/3-2 HP; U109-6A Swimquip P-61, XLII, XLIII, XLIV</p>	<p>MS-201 TYPE: A SHAFT DIA.: 3/4" Advance 6C-201 American 395005-Americana, Bronze-Noryl Baker Hydro 35B1109 Flint & Walling 126544, 126545 Gulf 34106201 For Power Tech Harmsco 201 Hayward SPX1600-Z-2-Max Flo, Super, Superll Homelite 75911-A Hydro (All) Jacuzzi 10-1390-04 For Magnum, RC; 10-0420-00, 10-0477-00, 10-0486-00, 10-0487-00, 10-1502-09 Luitweiler 3/4" x 1.373" Marlow 38592 For Argonaut, Mardur Martec 320-119 Pentair/Pac Fab 35-4001 For Hydropump; 35-0002, 35-4894 Premier 31-812-120T, 225/255, 300, 725/756 Purex P-28300 For L Series (Eastside); P-29300 For AH Series Sta Rite U9-358SS-JS, JT Series; U109-047 Swimquip For XLVI/XLVII Series, 37407-0019 Vico PPSFSEAL</p>	<p>MS-501 TYPE: A SHAFT DIA.: 5/8" Purex P-28322 For Aquatron</p>
<p>MS-101 TYPE: A SHAFT DIA.: 3/4" Myers 11416-A, A2, A3</p>	<p>MS-299 TYPE: A SHAFT DIA.: 5/8" Doughboy 306-1006</p>	<p>MS-601 TYPE: B SHAFT DIA.: 3/4" Jandy R0338200 Waterco 634016 For Supatuff Pump</p>
<p>MS-142 TYPE: B SHAFT DIA.: 1/2" Diaclear 35104, 36100 Lomart 040-028 Muskin 72008 (09-2013)</p>	<p>MS-358 TYPE: C SHAFT DIA.: 3/4" Jacuzzi 10-0479-00 Marine 15151</p>	<p>MS-642 TYPE: B SHAFT DIA.: 5/8" Doughboy 1128-1006</p>
<p>MS-150 TYPE: B SHAFT DIA.: 5/8" Lomart Muskin</p>	<p>MS-359 TYPE: C SHAFT DIA.: 5/8" Jacuzzi 10-0478-00, 10-0506-00, 10-1202-00</p>	<p>MS-703 TYPE: C SHAFT DIA.: 7/8" Marine 9524 Sta Rite U109-170 Cup Style</p>
<p>MS-162 TYPE: A SHAFT DIA.: 1/2" Jacuzzi 10-0563-00 Peerless 2665554 Sears 259-043, W6476 Sta Rite U109-068</p>	<p>MS-360 TYPE: A SHAFT DIA.: 1" Pentair/Pac Fab 07-1725 Purex P-28175 For C Series (Eastside)</p>	<p>MS-800 TYPE: C SHAFT DIA.: 5/8" Flint & Walling 131100, 132377, AC-16</p>
<p>MS-163 TYPE: B SHAFT DIA.: 1/2" Ampro 504-D Diaclear 35100 for Cast Iron, Lexan 200 Series; MS-12 Thru MS-18 Lomart 040-027, 040-029 Muskin 09-2001 Sta Rite U109-068</p>	<p>MS-372 TYPE: A SHAFT DIA.: 5/8" Hayward SPX0125-Z-2 Prior to 1967 Purex P-28128</p>	<p>MS-851 TYPE: A SHAFT DIA.: 3/4" Sta Rite 37400-00275</p>
<p>MS-163C TYPE: CERAMIC ONLY SHAFT DIA.: 5/8" Muskin 54048</p>	<p>MS-381 TYPE: C SHAFT DIA.: 1 1/4" Sta Rite U109-220 For CC, C, D Series</p>	<p>MS-877 TYPE: C SHAFT DIA.: 3/4" Jacuzzi 10-1203-01, 10-1203-19</p>
<p>MS-200 TYPE: A SHAFT DIA.: 5/8" Advance 6C-200 Ampro 606-78 Aqua Flo 92509020, 92500150, FF-14 Arneson A-08 Baker Hydro 35B1178 Doughboy 306-1007 Hayward SPX1250X-Z-2 For Cast Iron Jacuzzi 10-1436-00 For LCM, LCU, LR Series; 10-0476-00, 10-0002-06 Letro A-08 Lomart 1121-1057 Pentair/Pac Fab 35-4545 For Challenger, Dynamite, Dynamo, Dynatron, Pinnacle Poolco 2XL XLV SEAL for Vortex XL Pump Sta Rite 17304-0100 for Dura Glas, Maxi Glas (After 1998) WMC JS-1702</p>	<p>MS-406 TYPE: B SHAFT DIA.: 5/8" Marlow 26661, 26469</p>	<p>MS-1000 TYPE: B SHAFT DIA.: 5/8" Acura 1090 American 397012 For Americana II, Bronze-Bronze, Eagle, Maxim, Power Glas, Ultra Flo; 397020 Ampro AP-304D Aqua Flo 92509040 For A, B, C, D Series, Dominator; 92500050; AF-14 Aquatherm Spa Pack 16-070-200B Diaclear AP-304D Doughboy 306-1002, 306-1005, 1128-1006 H & F Lomart 047-015, 047-016, 304 Marine 7700 For A Series Martec 300-009, 310-108 Polaris P-55 For Vac Sweep Premier 31-813 For 455/456, 500, 600 Series Purex P-28323 For Whisperflo; P-28050 Sta Rite U109-136SS For CF, CFA, HP Ser. Swimrite 60-828-813 Waterway 811-1001AB, 318/9-3100B Wet Institute 34-050-311 (1000)</p>
<p>MS-411 TYPE: B SHAFT DIA.: 5/8" Marlow 25353, 26467, 23636, 26661</p>	<p>MS-416A TYPE: C SHAFT DIA.: 1 1/4" Marlow 27223 For 3B Series</p>	<p>MS-2131 TYPE: A SHAFT DIA.: 5/8" (INCLUDES PLASTIC HOUSING) Aqua Flo 91049000 For Flo Master, Tub Mstr. Baker Hydro 35131138, 35B1138 For Spa Pak Doughboy Power Pak II Gulf 341064702 For Power Tech II Hayward SPX1500-KA For PowerFlo, TurboFlo</p> <p><i>(Popular Pumps and Seal Cross Reference on next page)</i></p>

POPULAR PUMPS & SEAL CROSS REF.

FITS OEM	PUMP TYPE	FITS OEM#	SSC#	FITS OEM	PUMP TYPE	FITS OEM#	SSC#	
American Products	Americana	395005	MS-201	Muskin	--	09-2001	MS-163	
	Americana II	397012	MS-1000		--	09-2013	MS-142	
	Bronze-Bronze	397020	MS-1000	Pentair/Pac Fab	Challenger	35-4545	MS-200	
	Bronze-Noryl	395005	MS-201		Dynamite	35-4545	MS-200	
	Eagle	397012	MS-1000		Dynamo	35-4545	MS-200	
	Eagle	397020	MS-1000		Dynatron	35-4545	MS-200	
	Maxim	397012	MS-1000		Hydropump	35-4001	MS-201	
	Power Glas	397012	MS-1000		Pinnacle	35-4545	MS-200	
Ultra Flow	097020	MS-1000						
Ampro/Diaclear	Dia. Cast	AP-504D	MS-163	Polaris	Vac Sweep	P-55	MS-1000	
	Dura Flo	AP-304D	MS-1000					
	Lexan-200 Ser.	AP-504D	MS-163					
	Noryl Turbo	AP-304D	MS-1000					
	XL600	AP-304D	MS-1000					
Anthony	--	04380	MS-1000	Premier	120T Series	31-812	MS-201	
	--	04547	MS-100		220/225 Series	31-813	MS-1000	
			Pre 1988					
			225/255 MKII		31-812	MS-201		
			300 Series		31-813	MS-1000		
			Pre 1988					
			325/355 Series		31-812	MS-201		
			455/456 Series		31-813	MS-1000		
			500 Series		31-813	MS-1000		
			600 Series		31-813	MS-1000		
Aqua Flo	A Series	92509040	MS-1000	Purex/Pentair	AH Series	P-28300	MS-201	
	A Series	92500050	MS-1000		Aquatron	P-28322	MS-501	
	B Series	92509040	MS-1000		C Series	P-28175	MS-360	
	C Series	92500050	MS-1000		L Series	P-28300	MS-201	
	D Series	92509040	MS-1000		L Series	P-28280	MS-100	
	D Series	92500050	MS-1000		Whisperflo	P-28323	MS-1000	
	Dominator-High	92500150	MS-200	Richardson	E-Z Flo	--	MS-201	
	Pre-1995	92500050	MS-1000					
	Dominator-Med.	92500150	MS-200					
	Pre-1995	92500050	MS-1000					
	Flo Master	91049000	MS-2131					
	Flo Master	92500150	MS-200					
Tub Master	91049000	MS-2131	Sonfarrel (Martec)	Pool Master	320-119	MS-201		
Tub Master	92500150	MS-200		Spa Master	300-009	MS-1000		
Arneson	Pool Sweep	A-8	MS-200					
Baker Hydro	--	35B1178	MS-200	Sta Rite	AJ Series	U109-93SS	MS-100	
Diaclear	--	36100	MS-142		CC/C Series	U109-220	MS-381	
					CF/CFA Series	U109-136SS	MS-1000	
Doughboy	--	306-1002	MS-1000		D Series	U109-220	MS-381	
	--	306-1006	MS-200		DJ/JS/JT Series	U109-358SS	MS-201	
					Dura Glas	17304-0100S	MS-200	
					Dura Glas-Pre '98	U109-93SS	MS-100	
					Dura Glas II	U109-93SS	MS-201	
					Dura Glas II-Pre '98	U109-372SS	MS-201	
					Dura Jet	U109-358SS	MS-201	
					Dyna Glas/Max	U109-358SS	MS-201	
					Dyna Jet	17351-0101S	MS-201	
					HP Series	U109-136SS	MS-1000	
					JW/JWA5 Series	U109-358SS	MS-201	
					JWPA Series	U109-358SS	MS-201	
					LT Series	U109-68SS	MS-163	
					Max E Glas	17304-0100S	MS-200	
					Max E Glas-Pre '98	U109-93SS	MS-100	
				Max E Glas II	U109-358SS	MS-201		
				MaxEGlas II-Pre 98	U109-372SS	MS-201		
				PLBC Series	17351-102S	MS-100		
				PLBC Ser-Pre-'95	U109-93SS	MS-100		
Jacuzzi	8M	10-1203-01	MS-877	Swimquip	XL, VI/XL, VII	AS-201	MS-201	
	Cygnnet	10-0002-01	MS-200	Vico	Ultima	PPSFSEAL	MS-201	
	A Series	10-0002-06	MS-200					
	J, JCM Series	10-0002-06	MS-200	Waterway	A.G./Spa	811-1001AB	MS-1000	
	K, KM Series	10-0002-06	MS-200					
	LCM Series	10-1436-00	MS-200	WET Institute	WA	34-050-31	MS-1000	
	LCU Series	10-1436-00	MS-200					
	LR Series	10-0002-06	MS-200					
	Magnum	10-1502-09	MS-201	WMC	AT Series	SS-1600-Z-2	MS-201	
	RC Series	10-1502-09	MS-201		JS Series	JS-1702	MS-200	
	Vector (LVL)	10-0002-06	MS-200					
	Lomart	--	40-027	MS-163				
--		40-029	MS-163					

PUMP REPAIR/SERVICE KITS



SSC's Pump Repair and Service Kits (Go-Kits) make it quick and easy to service pumps. We eliminate the guesswork sometimes needed when getting the right parts together for pump repair or service. All kits include the necessary O-rings, gaskets and pump seals. Each kit's contents and application are clearly identified on the package. All are skin-packed for display and bar-coded.

AMERICAN PRODUCTS

R-6129

AMERICANA & BRONZE PUMP WITH NORYL IMPELLER

- G-5045 Seal Plate O-ring (1)
- MS-201 Pump Seal (1)
- O-2054 Lid O-ring (1)
- G-4409 Pot to Volute Gasket (1)
- O-2026 Volute O-ring (1)

R-6130

EAGLE PUMP

- O-2095 Volute O-ring (1)
- MS-1000 Pump Seal (1)
- O-2060 Lid O-ring (1)
- G-4284 Diffuser Gasket (1)

R-6149

MAXIM, AMERICANA II, POWER GLAS PUMPS

- MS-1000 Pump Seal (1)
- O-2079 Impeller O-ring (1)
- O-2066 Face Plate O-ring (1)
- O-2262 Volute O-ring (1)
- O-2218 Lid O-ring (1)
- G-4206 Water Slinger (1)

R-6143

ULTRA FLOW & BRONZE PUMP WITH BRONZE IMPELLER

- MS-1000 Pump Seal (1)
- O-2111 Diffuser Gasket (1)
- O-1082 Volute Gasket (1)
- G-4409 Pot to Volute Gasket (1)
- O-2054 Lid O-ring (1)
- O-2026 Volute O-ring (1)

R-6126

MULTIPOINT VALVE KIT BEFORE 1976

- G-5146 Teflon Backup O-ring (2)
- O-2133 Shaft O-ring (2)
- O-2410 Quad O-ring (1)
- G-5104 6 Spoke Gasket (1)

R-6127

UNIVERSAL SLIDE VALVE KIT FOR 1 1/2" & 2" BRONZE AND ABS

- G-3148 Valve Cap Gasket (1)
- O-2106 Valve Cap Body O-ring (1)
- O-2024 Stem & Shaft Cap O-ring (1)
- O-2115 Valve Cap O-ring (1)
- O-2068 Valve Piston O-ring (1)
- O-2126 Valve Stem O-ring (1)
- O-2142 Old Style Valve Piston O-ring (2)

R-6128

MULTIPOINT VALVE KIT AFTER 1976

- G-5146 Teflon Backup O-ring (2)
- O-2133 Shaft O-ring (2)
- O-2410 Quad O-ring (1)
- G-5105 5 Spoke Gasket (1)

ANTHONY

R-6111

2" PLASTIC SLIDE VLV-FITS #17810-17770

- O-2008 Piston O-ring (3)
- O-2024 Shaft O-ring (3)
- O-2106 Bulkhead Connector (2)

R-6112

UNIVERSAL SLIDE VALVE KIT FOR 1 1/2" & 2" BRONZE & ABS

- O-2008 Plastic Valve Piston O-ring (3)
- O-2024 Valve Shaft O-ring (3)
- O-2142 Piston Cap O-ring (3)
- O-2115 Piston Cap O-ring (3)
- O-2106 Plastic Vlv B/H Connector O-ring (2)

R-6154

1 1/2" BRASS SLIDE VALVE KIT

- O-2142 Piston O-ring (3)
- O-2024 Shaft O-ring (1)

AQUA FLO

R-6140

DOMINATOR HIGH & MEDIUM HEAD & C SERIES PUMP-BEFORE 1995

- MS-1000 Pump Seal (1)
- O-1082 Seal Plate O-ring (1)
- O-2226 Flange Volute O-ring (1)
- O-2128 Lid O-ring (1)
- O-2195 Diffuser O-ring (1)
- O-2067 Volute O-ring (1)

R-6145

DOMINATOR HIGH & MEDIUM HEAD AND XP SERIES PUMP-AFTER 1995

- MS-200 Pump Seal (1)
- O-1082 Seal Plate O-ring (1)
- O-2226 Flange Volute O-ring (1)
- O-2128 Lid O-ring (1)
- O-2195 Diffuser O-ring (1)
- O-2209 Volute O-ring For XP-D11 Series (1)

R-6141

FLO MASTER FMHP/FMCP/FMVP AND TUBMASTER YMCP/TMF

- MS-2131 Pump Seal (W/ Plastic Housing) (1)
- O-2262 Volute O-ring (1)
- O-2228 Lid O-ring (1)
- O-2025 Volute O-ring (1)
- O-2226 Flange O-ring (1)

R-6142

STANDARD A SERIES-5"

- MS-1000 Pump Seal (1)
- G-3256 Volute Gasket (1)
- G-3275 Trap Gasket (1)
- O-2228 Lid O-ring (1)

COLUMBIA

R-6153

BLUE SEAL ABOVE GROUND PUMP

- O-2128 Cover O-ring (1)
- MS-163 Pump Seal (1)

DOUGHBOY

R-6131

POWER PAK II PUMP

- MS-2131 Pump Seal (W/ Plastic Housing) (1)
- O-2104 Backplate O-ring-For Seal Hsg (1)
- O-2041 Diffuser O-ring (1)
- O-2286 Strainer Body O-ring (1)
- O-2231 O-ring (1)

R-6132

POWER PAK I, LOMART DYNAFLOW

- O-2119 Lid O-ring (1)
- MS-1000 Pump Seal (1)
- O-2017 Volute O-ring (1)
- O-2203 Basket Port O-ring (1)

HAYWARD

R-6106

CAST IRON PUMP-SP-1250 SERIES

- G-3128 Body Gasket (1)
- G-5039 Strainer Cover Gasket (1)
- G-5003 Diffuser Gasket (1)
- G-4227 Slinger (1)
- MS-200 Pump Seal (1)

R-6101

MAX FLO SERIES 1800-2800

- O-1209 Housing O-ring/Gasket (1)
- O-2618 Diffuser O-ring/Gasket (1)
- G-5039 Lid Gasket (1)
- MS-201 Pump Seal (1)

R-6104

POWERFLO PUMP-CLEAR COVER

- O-2152 Strainer Connector O-ring (1)
- G-3125 Pump Gasket-Fiber (1)
- O-2007 Pump Lid O-ring (1)
- MS-2131 Pump Seal (1)

R-6105

POWERFLO PUMP-SOLID COVER

- O-2152 Strainer Connector O-ring (1)
- G-3125 Pump Gasket-Fiber (1)
- O-2025 Valve Lid O-ring (1)
- MS-2131 Pump Seal (1)

R-6118

POWERFLO PUMP-1700 SERIES

- MS-2131 Pump Seal (1)
- MS-1000 Pump Seal (1)
- O-2143 Housing O-ring (1)
- O-2007 Strainer O-ring (1)
- O-2152 Strainer O-ring (1)

PUMP REPAIR / SERVICE KITS (GO-KITS)

R-6173

POWERFLO LX PUMP

MS-2131 Pump Seal (1)
O-2152 O-ring (1)
O-2209 O-ring (1)
O-2025 O-ring (1)

R-6174

NORTHSTAR PUMP

O-2307 Strainer Cover O-ring (1)
O-2047 Seal Plate O-ring (1)
O-2355 Diffuser O-ring (1)
MS-201 Pump Seal (1)

R-6103

SUPER PUMP-SERIES 1600, 2600, 2600X

O-1209 Housing O-ring/Gasket (1)
O-2618 Diffuser O-ring/Gasket (1)
O-1226 Lid O-ring/Gasket (1)
MS-201 Pump Seal (1)

R-6102

SUPER II PUMP-SERIES 3000-3000X

O-2618 Diffuser O-ring/Gasket (1)
O-2247 Pump Lid O-ring (1)
O-1217 Housing O-ring/Gasket (1)
MS-201 Pump Seal (1)

R-6117

TURBOFLO 2000-2100 & POWERFLO 1500 SERIES

MS-2131 Pump Seal (1)
G-4119 Housing Gasket-Rubber (1)
O-2025 Strainer Cover O-ring (1)
O-2007 Strainer Cover O-ring (1)
O-2152 Strainer O-ring (1)
O-2143 Housing O-ring (1)

R-6115

5 SPOKE MULTIPOINT REBUILD KIT-SPX710X/711

G-5106 5 Spoke Gasket (1)
O-2128 Cover O-ring (1)
G-3277 Non-Metallic Bearing Gasket (1)
O-2256 Stem O-ring (1)

R-6116

6 SPOKE MULTIPOINT REBUILD KIT-SPX710/711

G-5108 6 Spoke Gasket (1)
O-2025 Cover O-ring (1)
O-2133 Shaft O-ring (1)
G-5142 Teflon Washer (1)

R-6148

SPX410X SLIDE VALVE KIT

O-2155 Bonnet O-ring (1)
O-2135 Shaft O-ring (1)
O-2150 Large Piston O-ring (1)
O-2008 Small Piston O-ring (1)
O-2165 Connector O-ring (1)

R-6158

CL200 CHLORINATOR KIT

O-2511 Viton Cover O-ring (1)
K-6003 Viton O-ring Kit (1)
G-4267 Gasket (1)

JACUZZI

R-6164

8M & 10M PUMP

MS-877 Pump Seal (1)
G-4186 Rubber Pump Gasket (1)
G-4434 Valve Pump Gasket (1)

R-6163

CYGNET PUMP

MS-200 Pump Seal (1)
O-2059 Lid O-ring (1)
O-2024 O-ring (2)
O-2300 Case O-ring (1)

R-6161

J, JCM, K & KM PUMPS

MS-200 Pump Seal (1)
O-2266 Pump Lid O-ring (1)

R-6167

LPH, LPC, LTPH, LH & LTH PUMPS

MS-200 Pump Seal (1)
G-5060 Pump Square Ring (1)
O-2024 O-ring (2)
O-2304 Lid O-ring (1)

R-6147

LR SERIES PUMP

MS-200 Pump Seal (1)
O-2059 Lid O-ring (1)
O-2024 Plug O-ring (1)
G-5060 Bracket to Case O-ring (1)

R-6119

MAGNUM PUMP

MS-201 Pump Seal (1)
O-2058 Case O-ring (1)
O-2024 Plug O-ring (1)
O-2224 Strainer O-ring (1)
G-5031 Diff. Square Ring (1)

R-6168

P, PC, EP SERIES PUMPS

MS-877 Pump Seal (1)
O-2024 O-ring (2)
G-5046 Diffuser Gasket (1)
G-5035 Square Ring (1)
G-5016 Square Case Ring (1)

R-6165

PH & UPH PUMPS

MS-201 Pump Seal (1)
O-2304 Lid O-ring (1)
O-2024 O-ring (2)
G-5046 Diffuser Gasket (1)

R-6160

PJM PUMP

MS-877 Pump Seal (1)
O-2247 Lid O-ring (1)
G-4186 Rubber Pump Gasket (1)
O-2054 Lid O-ring (1)
G-4433 Flange Gasket (1)
G-3176 Gasket (1)

R-6120

R AND RC SERIES PUMPS

MS-201 Pump Seal (1)
G-5016 Bracket/Case Square Ring (1)
O-2024 Plug O-ring (2)
G-5046 Diff. Square Ring (1)
O-2041 Strainer O-ring (1)

R-6166

SLPH, SLTPH, LCU, LTCU, ULCU, LCM, L3 & L25 PUMPS

MS-200 Pump Seal (1)
O-2139 Lid O-ring (1)
O-2024 O-ring (2)
G-5060 Pump Square Ring (1)

R-6162

ULSB & ULSC PUMPS

MS-877 Pump Seal (1)
O-2266 Lid O-ring (1)
G-4186 Rubber Pump Gasket (1)

PENTAIR / PAC FAB

R-6108

CHALLENGER PUMP

MS-200 Pump Seal (1)
O-2015 Diffuser O-ring (1)
G-5061 Housing Square Ring-New Sty. (1)
O-2046 Housing O-ring-Old Style (1)
O-2226 Strainer O-ring (1)
O-2172 Lid O-ring (1)

R-6121

DYNAMO, DYNAMO II, DYNAMITE & DYNATRON PUMPS

MS-200 Pump Seal (1)
O-2040 Tank Side Ring (1)
O-2139 Tank Lid O-ring(1) (Dynamo II Only)
O-2195 Connection O-ring (2)
O-2214 Bracket Diff. O-ring-Before'93 (1)
O-2286 Bracket Diff. O-ring-After '93 (1)

R-6138

HYDRO PUMP

O-2262 Volute O-ring (1)
O-2106 Pot to Volute O-ring (1)
O-2028 Lid O-ring (1)
O-2080 New Style Lid O-ring (1)
O-2172 Old Style Lid O-ring (1)
MS-201 Pump Seal (1)

R-6139

PINNACLE PUMP

O-2294 Seal Bracket O-ring (1)
MS-200 Pump Seal (1)
O-2409 Diffuser O-ring (1)
O-2172 Lid O-ring (1)

R-6137

UNIVERSAL SLIDE VALVE KIT

-- Retainer Clips (5)
G-3271 Valve Cap Gasket (1)
O-2090 Shaft O-ring (1)
G-5112 Piston Seal (2)
G-5114 Piston Seal (2)
O-2068 Shaft O-ring (2)
O-2124 Diverter O-ring (1)
O-2040 Valve Cap O-ring (1)

R-6107
2" SLIDE VALVE REBUILD KIT
 O-2040 Cap O-ring (2)
 O-2090 Shaft O-ring (2)
 G-5114 Piston Gasket/O-ring (2)

POLARIS
R-6172
POLARIS BOOSTER PUMP-3/4 HP FOR 180, 280 & 380 MODELS
 MS-1000 Pump Seal (1)
 O-2209 Volute O-ring (1)
 O-2024 O-ring (1)

PREMIER
R-6171
355/225 MK2 PUMP
 MS-201 Pump Seal (1)
 O-2195 Tailpiece O-ring (1)
 O-2024 Drain Plug O-ring (1)
 O-2228 Lid O-ring (1)
 O-2262 Volute O-ring (1)

R-6146
555 NORYL
 MS-1000 Pump Seal (1)
 O-2226 Pot to Volute O-ring (1)
 O-2189 Pot to Volute O-ring (1)
 O-2228 Lid O-ring (1)
 O-2209 Volute O-ring (1)

R-6170
756 SERIES PUMP
 MS-201 Pump Seal (1)
 O-1082 O-ring (1)
 O-2167 Cover O-ring (1)
 O-2195 1 1/2" Tailpiece O-ring (1)
 O-2024 Shaft Extension O-ring (1)
 O-2135 2" Tailpiece O-ring (1)

PUREX
R-6124
AQUATRON PUMP
 MS-501 Pump Seal (1)
 O-2041 Lid O-ring (1)
 O-2209 Bracket to Volute Flange O-ring (1)

R-6123
C SERIES PUMP
 O-1067 Lid O-ring (1)
 G-4247 Pot to Volute Flange Gasket (1)
 MS-360 Pump Seal (1)
 O-2604 Bracket to Volute Flange Gask (1)

R-6122
L SERIES & AA SERIES PUMPS
 O-2247 Lid O-ring (1)
 G-3255 Pot to Volute Gasket (1)
 G-3247 Bracket to Volute Flange Gask (1)
 MS-201 Pump Seal (1)
 O-2138 Bracket to Volute O-ring (1)

R-6125
WHISPERFLO PUMP
 O-2216 Seal Plate O-ring (1)
 O-2103 Diffuser O-ring (1)
 O-2208 Impeller O-ring (1)
 MS-1000 Pump Seal (1)

STA RITE
R-6110
CAST IRON PUMP-PP1100-FITS ALL CK & CRA4 MODELS
 G-4253 Water Slinger (1)
 G-5034 Diffuser Ring (1)
 G-3259 Volute Gasket (1)
 O-2099 Cover O-ring (1)
 MS-100 Pump Seal (1)

R-6136
CF/CFA/CF6 SERIES PUMPS
 MS-1000 Pump Seal (1)
 G-3256 Volute Gasket (1)
 O-2167 Lid O-ring (1)
 O-2218 Trap O-ring (1)

R-6109
DURA GLAS/MAXI GLAS & P2RA/P2R PUMPS-BEFORE 1998
 O-1082 Housing O-ring (1)
 G-4411 Gasket (1)
 O-2195 Diffuser O-ring (1)
 O-2060 Lid O-ring (1)
 MS-100 Pump Seal (1)

R-6175
DURA GLAS/MAXI GLAS & P2RA/P2R PUMPS-AFTER-1998
 O-1082 Housing O-ring (1)
 G-4411 Gasket (1)
 O-2195 Diffuser O-ring (1)
 O-2060 Lid O-ring (1)
 MS-200 Pump Seal (1)

R-6144
DYNAGLAS & J SERIES PUMPS
 MS-201 Pump Seal (1)
 O-2002 Diffuser O-ring (1)
 O-2247 Lid O-ring (1)
 O-2266 Seal Plate O-ring-J Series (1)
 O-2305 Seal Plate O-ring-Dynaglas (1)

R-6150
FLO TECH PUMP-AQUATOOLS
 MS-201 Pump Seal (1)
 G-4253 Water Slinger (1)
 O-2002 Diffuser O-ring (1)
 O-2247 Cover O-ring (1)
 O-2305 Seal Plate O-ring (1)

R-6133
MAXI GLAS II & DURA GLAS II-P4E & P4EA PUMPS
 O-2142 Seal Plate O-ring (1)
 O-1082 Seal Plate Housing O-ring (1)
 MS-201 Pump Seal (1)
 O-2002 Diffuser O-ring (1)
 O-2247 Lid O-ring (1)

R-6134
PE & PEA SERIES, P2R & P2RA, AJ SERIES PUMPS
 MS-100 Pump Seal (1)
 O-1082 Clamp O-ring (1)
 O-2195 Diffuser O-ring (1)
 G-3226 Seal Plate Gasket (1)

R-6135
UNIVERSAL SLIDE VALVE KIT-FITS ALL 1 1/2" & 2" VALVES FOR STA RITE, SWIMQUIP, BAKER HYDRO, PUREX AND HYDROTECH
 O-2188 Valve Piston O-ring (3)
 O-2280 Valve Cap O-ring (1)
 O-2082 Index Plate O-ring (2)
 O-2134 Valve Piston O-ring (3)
 O-2010 Valve Piston O-ring (2)
 O-2042 Valve Piston O-ring (3)
 O-2004 Valve Piston O-ring (3)

WATERWAY
R-6155
48 FRAME PUMP
 MS-1000 Pump Seal (1)
 O-2025 Volute O-ring (1)
 O-2172 Lid O-ring (1)
 O-2024 Drain Plug O-ring (1)

R-6156
75-125-200 CYCLONE PUMP
 MS-1000 Pump Seal (1)
 O-2141 Drain Plug O-ring (1)
 O-2172 Lid O-ring (1)
 O-2041 Volute O-ring (1)

If the kit you need is not listed here, please let us know and we'll add it.

SSC offers over 250 different **Pressure, Compound, Vacuum, Liquid Filled and Water Test Gauges**. We have a wide selection at competitive prices. See pgs. 79-82.



FILTER O-RING / GASKET KITS (RO-KITS)

FILTER O-RING/GASKET KITS

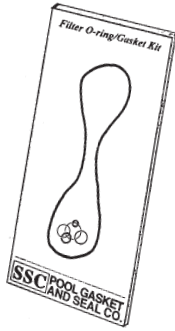

As with our pump kits, we have eliminated the guesswork sometimes needed when gathering parts to service cartridge, D.E. and sand filters. All Filter Kits include the necessary O-rings and gaskets and each kit's contents and application are clearly identified on the package. All are skin-packed for display and bar coded.

AMERICAN

F-8316

CARTRIDGE FILTER-COMMANDER 4 & 6 OZ.-25, 35, 50, 75 & 100 SQ. FT.

- O-2090 Gauge Plug O-ring (1)
- O-2129 Knob Seal O-ring (1)
- O-1059 Tank O-ring (1)

F-8317

CARTRIDGE FILTER-QUANTUM 43.7 & 87.5 SQ. FT.

- O-2231 Drain Plug O-ring (1)
- O-1039 Tank O-ring (1)

F-8215

D.E. FILTER-TITAN-STAINLESS STEEL

- O-2106 Outlet Pipe O-ring (1)
- O-2231 Drain Plug O-ring (1)
- O-2040 Inlet Pipe O-ring (After 1/1/90) (1)
- O-1039 Tank O-ring (Before 1/1/90) (1)
- O-2106 Inlet Pipe O-ring (Before 1/1/90) (1)
- G-4237 Bulkhead Gasket (1)
- G-4278 Bulkhead Gasket (1)

F-8107

SAND FILTER-OLYMPIAN

- O-2106 Bulkhead O-ring (Before 1/1/91) (1)
- O-2040 Bulkhead O-ring (After 1/1/91) (1)
- O-2060 Lid O-ring (1)
- G-4237 Bulkhead Gasket (1)
- G-4278 Thin Gasket (1)

BAKER HYDRO

F-8324

CARTRIDGE FILTER-HYDRO MITE-25, 50, 75, 100, SQ. FT.

- G-5006 Lid O-ring/Gasket (1)

HAYWARD

F-8301

CARTRIDGE FILTER-SUPER STAR CLEAR 3000 & 4000-75, 100 SQ. FT.

- O-2133 Filter O-ring (1)
- O-2270 Filter O-ring (2)
- O-2165 Filter O-ring (2)
- O-1001 Tank O-ring (1)

F-8302

CARTRIDGE FILTER-STAR CLEAR II-75, 100, 150 SQ. FT.

- O-2116 Locking Knob O-ring (1)
- O-1054 Filter O-ring (1)
- O-2261 O-ring (1)

F-8303

CARTRIDGE FILTER-STAR CLEAR-25, 50, 75 SQ. FT.

- O-1215 Tank O-ring (1)
- O-2116 Locking Knob O-ring (1)
- O-2261 O-ring (1)

F-8304

CARTRIDGE FILTER-MICRO STAR CLEAR IN-LINE-12, 20, 25 SQ. FT.

- O-2095 Lid O-ring (1)
- G-5033 Elbow O-ring (1)

F-8305

CARTRIDGE FILTER-SUPER STAR CLEAR C-3000S & C-4000S STAINLESS STEEL TANK-75, 100 SQ. FT.

- O-2040 Base O-ring (1)
- O-2155 Inlet Elbow O-ring (1)
- O-2208 Air Relief Valve Stem O-ring (1)
- O-1099 Tank O-ring (1)
- O-2308 Air Relief Valve Stem O-ring (2)
- G-4212 Valve/Head Gasket (1)

F-8306

CARTRIDGE FILTER-STAR CLEAR PLUS-C900 & C1200-90, 120 SQ. FT.

- O-1082 Filter Head O-ring (1)
- O-2239 Knob O-ring (1)
- O-2261 Drain Plug O-ring (1)
- G-3277 Knob & Cone Washer (2)

F-8201

D.E. FILTER-PERFLEX-EC-65 & EC-75

- O-2135 Bump Shaft O-ring (1)
- G-5152 Diaphragm Gasket-No Holes (1)

F-8202

D.E. FILTER-MICRO CLEAR-VERTICLE GRID-STAINLESS STEEL

- O-2106 Outlet Elbow O-ring (1)
- O-2040 Support Base O-ring (1)
- O-1099 Tank O-ring (1)
- O-2208 Relief Valve O-ring (3)
- G-4212 Relief Valve to Filter Head Gasket (1)

F-8203

D.E. FILTER-PERFLEX-EC-30,40, 50

- O-2135 Bump Shaft O-ring (1)
- G-5153 Diaphragm Gasket-w/ Holes (1)

F-8204

D.E. FILTER-MICRO CLEAR-VERTICLE GRID, DURALON & PERMAGLASS XL

- O-2106 Outlet Elbow O-ring (1)
- O-2208 Relief Valve Stem O-ring (1)
- O-2308 Relief Valve Stem O-ring (2)
- O-1001 Tank O-ring (1)

F-8101

SAND FILTER-GM SERIES-GM140, 142, 142-6, 152, 152HV

- O-2264 Drain Plug O-ring (1)
- O-2058 Valve Tank O-ring (1)
- O-2164 Valve Tank O-ring (1)

F-8102

SAND FILTER-PRO SERIES PLUS-S164T, S166T, S140T, S220T, S244T, S144T, S310T, S180T, S210T, S311X, S311SXV, S360SX, S210S, S220S, S244S, S310S

- O-2133 Air Relief Valve O-ring (1)
- O-2058 Valve Tank O-ring (1)
- O-2164 Valve Tank O-ring (1)
- G-4443 Drain Plug Gasket (1)

F-8103

SAND FILTER-160T

- O-2133 Drain Plug O-ring (Before 1980) (1)
- O-2261 Drain Plug O-ring (After 1980) (1)
- O-2091 Valve Head O-ring (1)
- O-1049 Tank O-ring (1)
- G-4325 Drain Plug Gasket (1)

F-8104

SAND FILTER-S-200

- O-2133 Air Relief O-ring (Before 1980) (1)
- O-2261 Drain Plug O-ring (After 1980) (1)
- O-1106 Tank O-ring (1)
- O-2091 Cap O-ring (1)
- G-4325 Drain Plug Gasket (1)

F-8105

SAND FILTER-S-240

- O-2133 Air Relief O-ring (Before 1980) (1)
- O-2261 Air Relief O-ring (After 1980) (1)
- O-2091 Cover O-ring (1)
- O-1044 Tank O-ring (1)
- G-4443 Drain Plug Gasket (1)

F-8106

SAND FILTER-S-245T & S-190T

- O-2058 Valve Tank O-ring (1)
- O-2261 Drain Plug O-ring (1)
- G-4325 Drain Plug Gasket (1)

JACUZZI

F-8315

CARTRIDGE FILTER-CFR SERIES-50, 75, 100, 150, 200 SQ. FT.

- O-2024 Stem & Crank O-ring (1)
- O-2181 Cover O-ring (1)

F-8314

CARTRIDGE FILTER-CFR 25 IN LINE-25 SQ. FT.

- O-2024 Stem & Crank O-ring (1)
- O-2095 Lid O-ring (1)

F-8322
CARTRIDGE FILTER-TRI-CLOPS & EARTHWORK-75, 150 SQ. FT.
 O-2024 Air Relief O-ring (1)
 O-2165 Bottom O-ring (1)
 O-2264 Manifold Knob O-ring (1)
 O-1015 Tank O-ring (1)

F-8216
D.E. FILTER-LANDSLIDE & SEPARATION TANK
 O-2024 Drain Plug O-ring (1)
 O-2143 Support O-ring (1)
 O-2181 Tank & Cover O-ring (1)

F-8218
D.E. FILTER-EARTHWORKS ONLY
 O-2024 O-ring (1)
 O-1015 Tank O-ring (1)
 O-2264 Valve Shaft O-ring (1)

F-8114
SAND FILTER-LASER-160L, 190L, 225L, 250L, LR3, LR6, MFM15
 O-2024 Drain Plug O-ring (1)
 O-2080 Flange O-ring (1)
 G-5023 Adapter Flange Gasket (1)

F-8119
SAND FILTER-MFM 17, 20, 24
 G-5023 Valve Gasket (1)
 O-2024 O-ring (1)
 O-2058 Bottom Drain O-ring (1)

F-8120
SAND FILTER-RMST-24, ST27, ST33
 O-2098 Filter Lid O-ring (1)
 O-2293 Valve to Adapter O-ring (1)
 O-1101 Valve Lid O-ring (1)
 O-2134 Drain Plug O-ring (1)

PAC FAB

F-8308
CARTRIDGE FILTER-MYTILUS & MITRA-50, 80, 100 SQ. FT.
 O-2141 Gauge & Air Bleeder Adptr O-rng(1)
 O-1048 Tank O-ring (1)

F-8309
CARTRIDGE FILTER-MITRA-60 SQ. FT.
 O-2141 Gauge & Air Bleeder Adptr O-rng(1)
 O-1070 Tank O-ring (1)

F-8310
CARTRIDGE FILTER-MYTILUS FMY FIBER-GLASS-80, 100, 150 SQ. FT. & MYTILUS FIBERGLASS REINFORCED POLYMERIC 60, 80, 100 SQ. FT.
 O-2141 Adapter O-ring (1)
 O-2002 Bulkhead Adapter O-ring (2)
 O-1048 Tank O-ring (1)
 O-2282 Bulkhead O-ring (1)
 G-4324 Bulkhead Diff. Gasket (1)

F-8311
CARTRIDGE FILTER-MYTILUS FIBER-GLASS REINFORCED POLYMERIC-60, 80, 100 SQ. FT.
 O-2141 Air Bleeder O-ring (1)
 O-1048 Tank O-ring (1)
 O-2115 Small Bottom Piping O-ring (1)
 O-2071 Large Bottom Piping O-ring (1)

F-8312
CARTRIDGE FILTER-MITRA STAINLESS STEEL-60, 80, 100 SQ. FT.
 O-2141 Air Bleeder O-ring (1)
 O-2002 Bulkhead Adapter O-ring (2)
 O-2282 2" Bulkhead O-ring (1)
 O-1070 Tank O-ring (1)
 G-4324 Bulkhead Diff. Gasket (1)

F-8211
D.E. FILTER-STAR FIBERGLASS REINFORCED POLYMERIC
 O-1048 Tank O-ring (1)
 O-2115 Small Bottom Center Pipe O-ring (2)
 O-2071 Large Bottom Center Pipe O-ring (1)
 O-2256 Shaft O-ring (1)
 O-2189 Gauge O-ring (1)

F-8212
D.E. FILTER-SM/SMBW 4000 SERIES
 O-2124 Rotor Valve O-ring (1)
 O-1029 Tank O-ring (1)

F-8217
D.E. FILTER-NAUTILUS STAINLESS STEEL
 O-2106 Filter Pump O-ring (1)
 O-1062 Tank O-ring (1)
 O-2002 Bulkhead Valve Adapter O-ring (1)
 O-2302 Bleeder Cartridge Filter O-ring (1)

F-8214
SAND FILTER-2000 SERIES, COLLECTOR & BACKWASH VALVE WITH BRASS & NORYL ROTOR
 O-2124 Rotor Shaft O-ring (1)
 O-2165 Collar Rotor O-ring (3)
 O-2220 Brass Rotor O-ring (1)
 O-2214 Valve Body O-ring (1)
 O-2226 Collar Rotor O-ring (1)

F-8108
SAND FILTER-FIBERGLASS
 O-2141 Air Bleeder Adapter O-ring (1)
 O-2041 Closure O-ring (1)
 O-2082 Drain Plug O-ring (1)
 O-2282 Drain Plug & Bulkhead O-ring (1)
 G-4324 Bulkhead Gasket (1)

F-8110
SAND FILTER-PF & 35/50 STAINLESS STEEL
 O-2100 1 1/2" Bulkhead O-ring (1)
 O-2141 Air Bleeder O-ring (1)
 O-2282 2" Bulkhead O-ring (1)
 O-1062 18" Tank O-ring (1)
 O-1056 22" Tank O-ring (1)
 G-4296 Bulkhead Gasket (1)

F-8111
SAND FILTER-PF-100 STAINLESS STEEL
 O-2141 Air Bleeder O-ring (1)
 O-2282 2" Bulkhead O-ring (1)
 O-1071 16" Tank O-ring (1)
 G-4324 2" Bulkhead Gasket (1)

F-8112
SAND FILTER-TAGLEUS FIBERGLASS-TA30D, TA35D, TA40D, TA50D, TA60D, TA100D, TA30, TA35, TA40, TA50, TA60
 O-2041 Valve Body & Valve Adptr O-ring (2)
 O-2082 Drain Plug O-ring (1)
 O-2091 Valve Body O-ring (1)
 O-2189 Standpipe O-ring (1)
 O-2226 Standpipe O-ring (1)
 O-2294 Valve Adapter O-ring (1)
 O-2292 Valve Body O-ring (1)

PUREX

F-8307
CARTRIDGE FILTER-CF-25 & CF-150-25, 150 SQ. FT.
 O-1063 Lid O-ring (1)

F-8109
SAND FILTER-TAHITIAN HI RATE
 O-2165 Valve Collar O-ring (1)
 O-2221 Rotor Shaft O-ring (1)

RAINBOW

F-8325
CARTRIDGE FILTER-3 & 4 OZ.-25, 50 SQ. FT.
 O-2135 Valve O-ring (1)
 O-2095 Lid O-ring (1)

STA RITE

F-8318
CARTRIDGE FILTER-POSI FLO-35, 50 SQ. FT.
 O-1010 Tank O-ring (1)

F-8319
CARTRIDGE FILTER-POSI FLO II-70, 100 SQ. FT.
 O-1010 Tank O-ring (1)
 O-2046 Lid O-ring (1)

F-8320
CARTRIDGE FILTER-POSI FLO EARLY & LATE MODELS-135 SQ. FT.
 O-2024 Air Release O-ring (1)
 O-1010 Tank O-ring (1)
 G-5061 Lid O-ring (1)

F-8321
CARTRIDGE FILTER-TXC25, TXC25B, TXC50, TXC50B, TXC75, TXC100
 O-2102 Knob O-ring (1)
 O-1215 Lid & Base O-ring (1)

FILTER O-RING / GASKET KITS (RO-KITS)

F-8205

D.E. FILTER-VERTICLE-DEP36, HRP20, HRP20-01B

O-2100 Cap O-ring (1)
O-1106 Tank O-ring (1)
O-2403 Outlet Elbow O-ring (1)

F-8206

D.E. FILTER-VERTICLE-DEP51, HRP24, HRP24-01B

O-2100 Cap O-ring (1)
O-1009 Tank O-ring (1)
O-2403 Outlet Elbow O-ring (1)

F-8207

D.E. FILTER-VERTICLE-DEP83, HRP30, HRP30-01B

O-2100 Cap O-ring (1)
O-1046 Tank O-ring (1)
O-2403 Outlet Elbow O-ring (1)

F-8208

D.E. AND SAND FILTER-VERTICLE-DES25, HRS16-01

O-1133 Tank O-ring (1)

F-8209

D.E. AND SAND FILTER-VERTICLE-DES36, HRS20-01

O-1015 Tank O-ring (1)

F-8210

D.E. AND SAND FILTER-VERTICLE-DES51, DES60, HRS24-01

O-1002 Tank O-ring (1)

F-8116

SAND FILTER-HIGH RATE-36"

G-5006 Lid O-ring (1)
G-5058 Bulkhead O-ring (1)

F-8117

SAND FILTER-PANTERA, PANTERA SKID SYSTEM & T-HRP

G-5012 Valve Tank Square Ring (1)

F-8118

SAND FILTER-SEPARATION TANK ASSEMBLY-415SW-820SW (DISCONTINUED IN 1992)

O-1048 Tank O-ring (1)

WATERWAY

F-8326

CARTRIDGE FILTER-TOP LOAD

O-2095 Lid O-ring (1)
O-2133 Air Bleeder O-ring (1)

If the kit you need is not listed here, please let us know and we'll add it.

Use SSC's Website to Find Your Replacement Parts and Order Online!

- Place orders online using our shopping cart feature.
- Find more than 2700 different listings of gaskets, O-rings and seals using our multi-functional "Part Search" engine. Part listings are also accompanied by a picture for your reference.
- Take advantage of our unique "View Past Orders" section to look at previous orders you've placed. You can then order from this list.
- This Website also enables you to save the current order you are working on by using our "Save Cart" feature. You can come back to it at another time if you are interrupted or save all of your orders for future reference. These can be activated to be your current order/cart at any time.
- Registration is required. This ensures that only Pool & Spa Dealers and Service Companies, not the general public, can see pricing and use the shopping cart.
- Download the SSC catalog, price list and all of our literature from the website.



www.poolgasket.com

GAUGES

PRESSURE, VACUUM & COMPOUND GAUGES

SSC's gauges are constructed with a steel case painted black, all brass internals and a glass lens. Competitively priced, the styles to choose from are pressure, vacuum or compound.

LM = LOWER MOUNT
CBM = CENTER BACK MOUNT

PRESSURE GAUGES

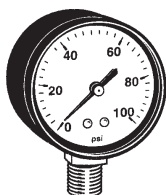

INDIVIDUALLY BOXED

SSC#	DIAL SIZE	MOUNT	PRESSURE
102902	1"	1/8" CBM	30
102903	1"	1/8" CBM	60
102904	1"	1/8" CBM	100
102905	1"	1/8" CBM	160
102907	1"	1/8" CBM	300
102921	1 1/2"	1/8" LM	15
102922	1 1/2"	1/8" LM	30
102923	1 1/2"	1/8" LM	60
102924	1 1/2"	1/8" LM	100
102925	1 1/2"	1/8" LM	160
102926	1 1/2"	1/8" LM	200
102927	1 1/2"	1/8" LM	300
103001	1 1/2"	1/8" CBM	15
103002	1 1/2"	1/8" CBM	30
102991	1 1/2"	1/8" CBM	60
103003	1 1/2"	1/8" CBM	100
102992	1 1/2"	1/8" CBM	160
102993	1 1/2"	1/8" CBM	200
103004	1 1/2"	1/8" CBM	300
102994	1 1/2"	1/8" CBM	400
102995	1 1/2"	1/8" CBM	600
103022	2"	1/8" LM	15
103023	2"	1/8" LM	30
103024	2"	1/8" LM	60
103025	2"	1/8" LM	100
103026	2"	1/8" LM	160
103027	2"	1/8" LM	200
103028	2"	1/8" LM	300
103029	2"	1/8" LM	400
103013	2"	1/4" LM	15
103014	2"	1/4" LM	30
103015	2"	1/4" LM	60
103016	2"	1/4" LM	100
103017	2"	1/4" LM	160
103018	2"	1/4" LM	200
103019	2"	1/4" LM	300
103020	2"	1/4" LM	400
103021	2"	1/4" LM	600
103031	2"	1/8" CBM	15
103032	2"	1/8" CBM	30
103033	2"	1/8" CBM	60
103034	2"	1/8" CBM	100
103035	2"	1/8" CBM	160

SSC#	DIAL SIZE	MOUNT	PRESSURE
103036	2"	1/8" CBM	200
103037	2"	1/8" CBM	300
103039	2"	1/8" CBM	600
103041	2"	1/4" CBM	15
103008	2"	1/4" CBM	30
103009	2"	1/4" CBM	60
103010	2"	1/4" CBM	100
103042	2"	1/4" CBM	160
103011	2"	1/4" CBM	200
103012	2"	1/4" CBM	300
103043	2"	1/4" CBM	400
103044	2"	1/4" CBM	600
103104	2 1/2"	1/4" LM	15
103105	2 1/2"	1/4" LM	30
103106	2 1/2"	1/4" LM	60
103107	2 1/2"	1/4" LM	100
103108	2 1/2"	1/4" LM	160
103109	2 1/2"	1/4" LM	200
103110	2 1/2"	1/4" LM	300
103111	2 1/2"	1/4" LM	400
103112	2 1/2"	1/4" LM	600
103099	2 1/2"	1/4" CBM	15
103100	2 1/2"	1/4" CBM	30
103101	2 1/2"	1/4" CBM	60
103102	2 1/2"	1/4" CBM	100
103120	2 1/2"	1/4" CBM	160
103121	2 1/2"	1/4" CBM	200
103122	2 1/2"	1/4" CBM	300
103123	2 1/2"	1/4" CBM	400
103124	2 1/2"	1/4" CBM	600
103200	3 1/2"	1/4" LM	15
103202	3 1/2"	1/4" LM	30
103203	3 1/2"	1/4" LM	60
103204	3 1/2"	1/4" LM	100
103205	3 1/2"	1/4" LM	160
103206	3 1/2"	1/4" LM	200
103207	3 1/2"	1/4" LM	300
103208	3 1/2"	1/4" LM	400
103209	3 1/2"	1/4" LM	600
103201	3 1/2"	1/4" CBM	30
103221	3 1/2"	1/4" CBM	60
103222	3 1/2"	1/4" CBM	100
103223	3 1/2"	1/4" CBM	160
103224	3 1/2"	1/4" CBM	200
103225	3 1/2"	1/4" CBM	300
103226	3 1/2"	1/4" CBM	400
103227	3 1/2"	1/4" CBM	600
103301	4 1/2"	1/4" LM	15
103302	4 1/2"	1/4" LM	30
103303	4 1/2"	1/4" LM	60
103304	4 1/2"	1/4" LM	100
103305	4 1/2"	1/4" LM	160
103306	4 1/2"	1/4" LM	200
103307	4 1/2"	1/4" LM	300
103308	4 1/2"	1/4" LM	400
103309	4 1/2"	1/4" LM	600
103322	4 1/2"	1/4" CBM	30
103323	4 1/2"	1/4" CBM	60
103324	4 1/2"	1/4" CBM	100
103325	4 1/2"	1/4" CBM	160
103326	4 1/2"	1/4" CBM	200
103327	4 1/2"	1/4" CBM	300

GAUGES

VACUUM GAUGES



INDIVIDUALLY BOXED

SSC#	DIAL SIZE	MOUNT	VACUUM
104990	1 1/2"	1/8" LM	30
104991	1 1/2"	1/8" CBM	30
105002	2"	1/8" LM	30
105001	2"	1/4" LM	30
105003	2"	1/8" CBM	30
105004	2"	1/4" CBM	30
105011	2 1/2"	1/4" LM	30
105012	2 1/2"	1/4" CBM	30

COMPOUND GAUGES

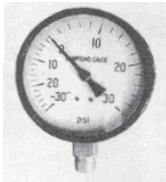

INDIVIDUALLY BOXED

SSC#	DIAL SIZE	MOUNT	VAC / PRESS
101951	1 1/2"	1/8" LM	30 / 30
101961	1 1/2"	1/8" CBM	30 / 30
102000	2"	1/8" LM	30 / 30
102001	2"	1/8" LM	30 / 60
102002	2"	1/8" LM	30 / 150
102003	2"	1/8" LM	30 / 300
101971	2"	1/4" LM	30 / 30
101972	2"	1/4" LM	30 / 60
101973	2"	1/4" LM	30 / 150
101974	2"	1/4" LM	30 / 300
101991	2"	1/8" CBM	30 / 30
101992	2"	1/8" CBM	30 / 60
101993	2"	1/8" CBM	30 / 150
101994	2"	1/8" CBM	30 / 300
101981	2"	1/4" CBM	30 / 30
101982	2"	1/4" CBM	30 / 60
101983	2"	1/4" CBM	30 / 150
101984	2"	1/4" CBM	30 / 300
102011	2 1/2"	1/4" LM	30 / 30
102012	2 1/2"	1/4" LM	30 / 60
102013	2 1/2"	1/4" LM	30 / 150
102014	2 1/2"	1/4" LM	30 / 300
102021	2 1/2"	1/4" CBM	30 / 30
102022	2 1/2"	1/4" CBM	30 / 60
102023	2 1/2"	1/4" CBM	30 / 150
102024	2 1/2"	1/4" CBM	30 / 300
102031	3 1/2"	1/4" LM	30 / 30
102032	3 1/2"	1/4" LM	30 / 60
102033	3 1/2"	1/4" LM	30 / 150

PLASTIC CASE GAUGES

Our plastic case gauges are corrosion and weather resistant. They can be used in extreme environmental situations such as outdoor use or very wet areas where a standard gauge might rust. These economical gauges are constructed with a plastic case, a plastic lens and all brass internals.

PLASTIC CASE PRESSURE GAUGES

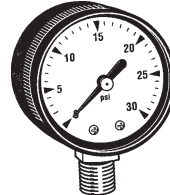

INDIVIDUALLY BOXED

SSC#	DIAL SIZE	MOUNT	PRESSURE
103013PL	2"	1/4" LM	15
103014PL	2"	1/4" LM	30
103015PL	2"	1/4" LM	60
103016PL	2"	1/4" LM	100
103017PL	2"	1/4" LM	160
103018PL	2"	1/4" LM	200
103019PL	2"	1/4" LM	300
103041PL	2"	1/4" CBM	15
103008PL	2"	1/4" CBM	30
103009PL	2"	1/4" CBM	60
103010PL	2"	1/4" CBM	100
103042PL	2"	1/4" CBM	160
103011PL	2"	1/4" CBM	200
103012PL	2"	1/4" CBM	300

PLASTIC CASE VACUUM GAUGES

105001PL	2"	1/4" LM	30VAC
105004PL	2"	1/4" CBM	30VAC

A Picture is Worth a Thousand Words...

Our Gasket Picture Guide (pgs. 60-70) shows all of the gaskets we offer in SSC# order. Gasket dimensions are also included for proper identification.

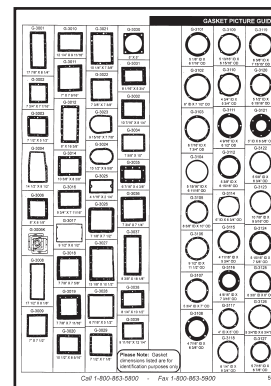

LIQUID (GLYCERIN) FILLED GAUGES

SSC's glycerin filled gauges are good for applications where there is a lot of movement. The liquid inside the gauge acts as a vibration and pulsation damper giving the technician a more accurate read. They are constructed with a stainless steel case, a plastic lens and all brass internals.

LM = LOWER MOUNT
CBM = CENTER BACK MOUNT

LIQUID FILLED PRESSURE GAUGES



INDIVIDUALLY BOXED

SSC#	DIAL SIZE	MOUNT	PRESSURE
100301	1 1/2"	1/8" LM	15
100302	1 1/2"	1/8" LM	30
100303	1 1/2"	1/8" LM	60
100304	1 1/2"	1/8" LM	100
100305	1 1/2"	1/8" LM	160
100306	1 1/2"	1/8" LM	200
100307	1 1/2"	1/8" LM	300
100310	1 1/2"	1/8" CBM	15
100311	1 1/2"	1/8" CBM	30
100312	1 1/2"	1/8" CBM	60
100313	1 1/2"	1/8" CBM	100
100314	1 1/2"	1/8" CBM	160
100315	1 1/2"	1/8" CBM	200
100316	1 1/2"	1/8" CBM	300
100318	1 1/2"	1/8" CBM	600
100332	2"	1/8" LM	30
100333	2"	1/8" LM	60
100334	2"	1/8" LM	100
100335	2"	1/8" LM	160
100336	2"	1/8" LM	200
100337	2"	1/8" LM	300
100339	2"	1/8" LM	600
100340	2"	1/4" LM	15
100341	2"	1/4" LM	30
100342	2"	1/4" LM	60
100343	2"	1/4" LM	100
100344	2"	1/4" LM	160
100345	2"	1/4" LM	200
100346	2"	1/4" LM	300
100348	2"	1/4" LM	600
100350	2"	1/8" CBM	30
100351	2"	1/8" CBM	60
100352	2"	1/8" CBM	100
100353	2"	1/8" CBM	160
100354	2"	1/8" CBM	200
100355	2"	1/8" CBM	300
100357	2"	1/8" CBM	600
100358	2"	1/4" CBM	15
100359	2"	1/4" CBM	30
100360	2"	1/4" CBM	60
100361	2"	1/4" CBM	100
100362	2"	1/4" CBM	160
100363	2"	1/4" CBM	200

SSC#	DIAL SIZE	MOUNT	PRESSURE
100364	2"	1/4" CBM	300
100366	2"	1/4" CBM	600
100381	2 1/2"	1/4" LM	15
100382	2 1/2"	1/4" LM	30
100383	2 1/2"	1/4" LM	60
100384	2 1/2"	1/4" LM	100
100385	2 1/2"	1/4" LM	160
100386	2 1/2"	1/4" LM	200
100387	2 1/2"	1/4" LM	300
100388	2 1/2"	1/4" LM	400
100389	2 1/2"	1/4" LM	600
100390	2 1/2"	1/4" CBM	15
100391	2 1/2"	1/4" CBM	30
100392	2 1/2"	1/4" CBM	60
100393	2 1/2"	1/4" CBM	100
100394	2 1/2"	1/4" CBM	160
100395	2 1/2"	1/4" CBM	200
100396	2 1/2"	1/4" CBM	300
100397	2 1/2"	1/4" CBM	400
100398	2 1/2"	1/4" CBM	600
100410	4"	1/4" LM	15
100411	4"	1/4" LM	30
100412	4"	1/4" LM	60
100413	4"	1/4" LM	100
100414	4"	1/4" LM	160
100415	4"	1/4" LM	200
100416	4"	1/4" LM	300
100417	4"	1/4" LM	400
100418	4"	1/4" LM	600
100419	4"	1/4" CBM	15
100420	4"	1/4" CBM	30
100421	4"	1/4" CBM	60
100422	4"	1/4" CBM	100
100423	4"	1/4" CBM	160
100424	4"	1/4" CBM	200
100425	4"	1/4" CBM	300
100426	4"	1/4" CBM	400
100427	4"	1/4" CBM	600

LIQUID FILLED VACUUM GAUGES

100461	1 1/2"	1/8" CBM	30VAC
100462	2"	1/8" LM	30VAC
100463	2"	1/4" LM	30VAC
100464	2"	1/8" CBM	30VAC
100465	2"	1/4" CBM	30VAC
100466	2 1/2"	1/4" LM	30VAC
100467	2 1/2"	1/4" CBM	30VAC
100468	4"	1/4" LM	30VAC
100469	4"	1/4" CBM	30VAC

If we are missing the gauge you need let us know and we'll try to get it.

Liquid Filled Compound Gauges start on next page...

GAUGES

LIQUID FILLED COMPOUND GAUGES

SSC#	DIAL SIZE	MOUNT	VAC / PRESS.
100105	1 1/2"	1/8" CBM	30 / 30
100125	2"	1/4" LM	30 / 30
100126	2"	1/4" LM	30 / 60
100127	2"	1/4" LM	30 / 150
100150	2 1/2"	1/4" LM	30 / 30
100151	2 1/2"	1/4" LM	30 / 60
100152	2 1/2"	1/4" LM	30 / 150
100153	2 1/2"	1/4" LM	30 / 300
100154	2 1/2"	1/4" CBM	30 / 30
100155	2 1/2"	1/4" CBM	30 / 60
100156	2 1/2"	1/4" CBM	30 / 150
100157	2 1/2"	1/4" CBM	30 / 300
100170	4"	1/4" LM	30 / 30
100171	4"	1/4" LM	30 / 60
100172	4"	1/4" LM	30 / 150
100173	4"	1/4" LM	30 / 300
100174	4"	1/4" CBM	30 / 30
100175	4"	1/4" CBM	30 / 60
100176	4"	1/4" CBM	30 / 150
100177	4"	1/4" CBM	30 / 300

BRASS ADAPTER FITTINGS FOR GAUGES

Our Brass Adapter Fittings are handy to have in case the service technician needs to convert the pipe thread size for the gauge opening on the equipment he is working on to another size to fit the particular gauge he has in his tool box.



BRASS

SSC# CONVERTS THESE PIPE THREADS

106875	1/8" MALE TO 1/4" FEMALE
106876	1/4" MALE TO 1/8" FEMALE
106878	3/8" MALE TO 1/8" FEMALE
106880	3/8" MALE TO 1/4" FEMALE
106882	1/2" MALE TO 1/8" FEMALE
106884	1/2" MALE TO 1/4" FEMALE
106886	3/4" MALE TO 1/8" FEMALE
106888	3/4" MALE TO 1/4" FEMALE
106890	1" MALE TO 1/4" FEMALE

NEEDLE VALVES

SSC's needle valves are handy to use when leaving gauges on equipment. Open the valve to test pressure and turn off when not in use.



FIP x FIP

BRASS



FIP x MIP

SSC#	SIZE
122040	1/8" FIP x 1/8" FIP
122042	1/4" FIP x 1/4" FIP
122046	1/8" FIP x 1/8" MIP
122048	1/4" FIP x 1/8" MIP

WATER TEST GAUGES



INDIVIDUALLY BOXED

106001

WATER TEST GAUGE

2 1/2" Dial Size
3/4" Female Garden Hose Connection; 0-300 PSI
Made of all brass internals, brass fitting, plastic body and plastic lens.

WITH LAZY HAND

The regular pressure hand pushes the lazy hand to the peak operating or surge pressure point where it remains until you manually reset it. The lazy hand comes in handy when you have to determine if equipment is malfunctioning due to intermittent surging pressure.



INDIVIDUALLY BOXED

106002

WATER TEST GAUGE

WITH LAZY HAND
2 1/2" Dial Size
3/4" Female Garden Hose Connection; 0-300 PSI
Made of all brass internals, brass fitting, plastic body and plastic lens.

BRASS ADAPTER FOR WATER TEST GAUGE

Use this adapter to turn any gauge you have on hand temporarily into a water test gauge.



106005

BRASS ADAPTER FOR WATER TEST GAUGE
3/4" Female Garden Hose Connection X 1/4" Female Fitting

SNUBBERS

Snubbers even out spikes in pressure for a more accurate reading.

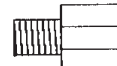

106870

BRASS SNUBBER FOR GAUGES

1/4" Female NPT x 1/4" Male NPT

106872

BRASS SNUBBER FOR GAUGES

1/2" Female NPT x 1/2" Male NPT

106868

STAINLESS STEEL SNUBBER FOR GAUGES

1/4" Female NPT x 1/4" Male NPT

SCHRADER VALVE

This bicycle type air valve allows the service technician to enter air into any system with a compressor or hand pump. It's handy for pressure testing tanks, plumbing systems, pipe, etc.



107140

SCHRADER VALVE
1/8" NPT

GASKET SHEETS

GASKET SHEETS



Available in various thicknesses, SSC's gasket sheets are perfect for emergency repairs and for replacing hard to find gaskets and washers. All materials can be cut into any shape or size. Available in the following materials and sizes:

CORK-RUBBER

The highest quality material of its kind, it can be used to seal applications involving oil or water. It will not shrink, stretch or lose bolt tension.

SSC#	SIZE
GS-1A	6" x 6" x 1/32" TH
GS-1B	6" x 6" x 1/16" TH
GS-1C	12" x 12" x 1/32" TH
GS-1D	12" x 12" x 1/16" TH
GS-1E	24" x 24" x 1/32" TH
GS-1F	24" x 24" x 1/16" TH
GS-1G	20" x 40" x 1/32" TH
GS-1H	20" x 40" x 1/16" TH

BUNA-N RUBBER

This black rubber is ideal for sealing oil applications. It has a high nitrile content which means it is oil resistant.

SSC#	SIZE
GS-2A	6" x 6" x 1/32" TH
GS-2B	6" x 6" x 1/16" TH
GS-2C	6" x 6" x 3/32" TH
GS-2D	6" x 6" x 1/8" TH
GS-2E	12" x 12" x 1/32" TH
GS-2F	12" x 12" x 1/16" TH
GS-2G	12" x 12" x 3/32" TH
GS-2H	12" x 12" x 1/8" TH
GS-2I	24" x 24" x 1/32" TH
GS-2J	24" x 24" x 1/16" TH
GS-2K	24" x 24" x 3/32" TH
GS-2L	24" x 24" x 1/8" TH
GS-2M	20" x 36" x 1/32" TH
GS-2N	20" x 36" x 1/16" TH
GS-2P	20" x 36" x 3/32" TH
GS-2Q	20" x 36" x 1/8" TH

GASKET CUTTING SHEARS

These shears make gasket cutting easy, especially when working with thick material. The design also allows for an accurate cut.



GS-100SH
HEAVY-DUTY SHEARS
FOR CUTTING GASKET
MATERIAL
Made of Hot Drop Forged
Nickel-Plated Steel

RED RUBBER (RAINBOW PACKING)

The most popular rubber for sealing water applications, it can be used on everything from pipe flanges to pump housings. Not to be put in contact with any petroleum product.

SSC#	SIZE
GS-3A	6" x 6" x 1/16" TH
GS-3B	6" x 6" x 1/8" TH
GS-3C	12" x 12" x 1/16" TH
GS-3D	12" x 12" x 1/8" TH
GS-3E	12" x 24" x 1/8" TH
GS-3F	18" x 36" x 1/8" TH
GS-3G	24" x 24" x 1/16" TH
GS-3H	24" x 24" x 1/8" TH
GS-3I	20" x 36" x 1/16" TH

TAN FIBER (FOR OIL)

This has been used successfully in the oil industry for over 20 years. It will seal oil or water.

SSC#	SIZE
GS-4M	6" x 6" x 1/64" TH
GS-4A	6" x 6" x 1/32" TH
GS-4B	6" x 6" x 1/16" TH
GS-4N	12" x 12" x 1/64" TH
GS-4C	12" x 12" x 1/32" TH
GS-4D	12" x 12" x 1/16" TH
GS-4P	24" x 24" x 1/64" TH
GS-4E	24" x 24" x 1/32" TH
GS-4F	24" x 24" x 1/16" TH
GS-4Q	20" x 40" x 1/64" TH
GS-4G	20" x 40" x 1/32" TH
GS-4H	20" x 40" x 1/16" TH

HIGH DENSITY CORK-RUBBER

This high grade material can be used in oil or water applications. It forms to imperfections on the flange and is very durable.

SSC#	SIZE
GS-5A	6" x 6" x 1/32" TH
GS-5B	12" x 12" x 1/32" TH
GS-5C	24" x 24" x 1/32" TH
GS-5D	20" x 36" x 1/32" TH

TAN FIBER (FOR WATER)

This fiber material is designed to be used in applications involving the sealing of water. Especially good for pump housings and flanges. Not to be used in oil applications.

SSC#	SIZE
GS-6A	6" x 6" x 1/32" TH
GS-6B	6" x 6" x 1/16" TH
GS-6C	12" x 12" x 1/32" TH
GS-6D	12" x 12" x 1/16" TH
GS-6E	24" x 24" x 1/32" TH
GS-6F	24" x 24" x 1/16" TH
GS-6G	20" x 40" x 1/32" TH
GS-6H	20" x 40" x 1/16" TH

GASKET SHEETS

BLACK FIBER

This material for higher temperatures can be used in oil or water. It is frequently used for applications like steam and hot water.

SSC#	SIZE
GS-7A	6" x 6" x 1/32" TH
GS-7B	6" x 6" x 1/16" TH
GS-7C	12" x 12" x 1/32" TH
GS-7D	12" x 12" x 1/16" TH
GS-7E	24" x 24" x 1/32" TH
GS-7F	24" x 24" x 1/16" TH
GS-7G	20" x 40" x 1/32" TH
GS-7H	20" x 40" x 1/16" TH

BLACK FIBER WITH ANTI-STICK COATING

Same as black fiber except with the added feature of anti-stick coating. This allows easy removal from flanges.

SSC#	SIZE
GS-8A	6" x 6" x 1/32" TH
GS-8B	6" x 6" x 1/16" TH
GS-8C	12" x 12" x 1/32" TH
GS-8D	12" x 12" x 1/16" TH
GS-8E	24" x 24" x 1/32" TH
GS-8F	24" x 24" x 1/16" TH
GS-8G	20" x 40" x 1/32" TH
GS-8H	20" x 40" x 1/16" TH

NON-ASBESTOS

This is the most popular material used for pipe flange gaskets and gaskets used in higher pressure applications. Excellent with water but not with oil/petroleum product.

SSC#	SIZE
GS-9A	6" x 6" x 1/16" TH
GS-9B	6" x 6" x 1/8" TH
GS-9C	12" x 12" x 1/16" TH
GS-9D	12" x 12" x 1/8" TH
GS-9E	24" x 24" x 1/16" TH
GS-9F	24" x 24" x 1/8" TH
GS-9G	20" x 36" x 1/16" TH
GS-9H	20" x 36" x 1/8" TH

Use SSC's Website to Find Your Replacement Parts and Order Online!

- Place orders online using our shopping cart feature.
- Find your part using our multi-functional "Part Search" engine.
- Registration is required. This ensures that only Pool & Spa Dealers and Service Companies, not the general public, can see pricing and use the shopping cart.

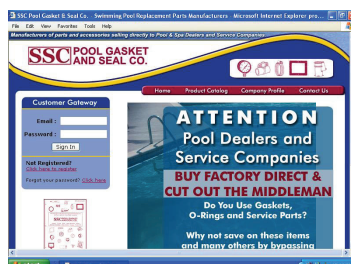

www.poolgasket.com

NEOPRENE

This black rubber is the most popular rubber in the world. Automobile tires are made of neoprene. Very effective in sealing water, it will not dry out or harden as fast as Red Rubber. Do not use this rubber in oil/petroleum product as it will swell up and then break down.

SSC#	SIZE
GS-10A	6" x 6" x 1/32" TH
GS-10B	6" x 6" x 1/16" TH
GS-10C	6" x 6" x 3/32" TH
GS-10D	6" x 6" x 1/8" TH
GS-10E	6" x 6" x 3/16" TH
GS-10F	6" x 6" x 1/4" TH
GS-10G	12" x 12" x 1/32" TH
GS-10H	12" x 12" x 1/16" TH
GS-10I	12" x 12" x 3/32" TH
GS-10J	12" x 12" x 1/8" TH
GS-10K	12" x 12" x 3/16" TH
GS-10L	12" x 12" x 1/4" TH
GS-10M	24" x 24" x 1/32" TH
GS-10N	24" x 24" x 1/16" TH
GS-10P	24" x 24" x 3/32" TH
GS-10Q	24" x 24" x 1/8" TH
GS-10R	24" x 24" x 3/16" TH
GS-10S	24" x 24" x 1/4" TH
GS-10T	20" x 36" x 1/32" TH
GS-10U	20" x 36" x 1/16" TH
GS-10V	20" x 36" x 3/32" TH
GS-10W	20" x 36" x 1/8" TH
GS-10X	20" x 36" x 3/16" TH
GS-10Y	20" x 36" x 1/4" TH
GS-10TA	12" x 24" x 1/8" TH
GS-10TB	12" x 24" x 1/4" TH
GS-10TC	18" x 36" x 1/8" TH
GS-10TD	18" x 36" x 1/4" TH

EPDM

The "Cadillac" of rubber, this black rubber will withstand higher heat and tends not to dry out or harden in extreme environments. This is the material of choice for higher heat steam application such as boiler handhole and manhole gaskets.

SSC#	SIZE
GS-11A	6" x 6" x 1/8" TH
GS-11B	6" x 6" x 1/4" TH
GS-11C	12" x 12" x 1/8" TH
GS-11D	12" x 12" x 1/4" TH
GS-11E	24" x 24" x 1/8" TH
GS-11F	24" x 24" x 1/4" TH
GS-11G	20" x 36" x 1/8" TH
GS-11H	20" x 36" x 1/4" TH
GS-11J	12" x 24" x 1/8" TH
GS-11K	12" x 24" x 1/4" TH
GS-11L	18" x 36" x 1/8" TH
GS-11M	18" x 36" x 1/4" TH

GASKET SHEETS / O-RING CORD

RED EPDM

This rubber has the same properties as black EPDM except it is a much softer material. Good for higher temperature applications where the flange surface is flat or pitted.

SSC#	SIZE
GS-12A	6" x 6" x 3/32" TH
GS-12B	12" x 12" x 3/32" TH
GS-12C	24" x 24" x 3/32" TH
GS-12D	20" x 36" x 3/32" TH

WHITE BUNA-N RUBBER

This material has the same properties as the black Buna-N. It is a high grade material and will not stain equipment.

SSC#	SIZE
GS-14A	6" x 6" x 3/32" TH
GS-14B	12" x 12" x 3/32" TH
GS-14C	24" x 24" x 3/32" TH
GS-14D	20" x 36" x 3/32" TH

FIBERGLASS SHEETS

This high temperature material (good to 1000°F) is perfect for most gasketing or insulating applications involving boilers and furnaces.

SSC#	SIZE
GS-15A	6" x 6" x 1/8" TH
GS-15B	12" x 12" x 1/8" TH
GS-15C	17" x 24" x 1/8" TH
GS-15D	17" x 36" x 1/8" TH

SHIM STOCK MATERIAL

Use this material to shim up an area in small increments.

SSC#	COLOR	SIZE
GS-16A	ORANGE	6" x 6" x .002" TH
GS-16B	ORANGE	12" x 12" x .002" TH
GS-16C	ORANGE	20" x 50" x .002" TH
GS-16D	CREAM	6" x 6" x .003" TH
GS-16E	CREAM	12" x 12" x .003" TH
GS-16F	CREAM	20" x 50" x .003" TH
GS-16G	CLEAR	6" x 6" x .004" TH
GS-16H	CLEAR	12" x 12" x .004" TH
GS-16J	CLEAR	20" x 50" x .004" TH
GS-16K	PURPLE	6" x 6" x .005" TH
GS-16L	PURPLE	12" x 12" x .005" TH
GS-16M	PURPLE	20" x 50" x .005" TH

ALUMINIZED HIGH TEMPERATURE CLOTH

Rated at 2300°, this material is excellent as a thermal barrier. It is used primarily as a **flame shield** when welding or soldering.

SSC#	SIZE
GS-18A	6" x 6" x 1/32" TH
GS-18B	12" x 12" x 1/32" TH
GS-18C	24" x 24" x 1/32" TH
GS-18D	20" x 36" x 1/32" TH

FULL ROLLS OF RED RUBBER (RAINBOW PACKING)



GS-3Y
1/16" THICK RED RUBBER
RAINBOW PACKING
100 lb Roll

GS-3Z
1/8" THICK RED RUBBER
RAINBOW PACKING
100 lb Roll

FULL ROLLS OF NEOPRENE RUBBER



GS-10TX
1/16" THICK
NEOPRENE RUBBER
100 lb Roll

GS-10TY
1/8" THICK
NEOPRENE RUBBER
100 lb Roll

FULL ROLLS OF BUNA-N RUBBER



GS-2Y
1/16" THICK
BUNA-N RUBBER
100 lb Roll

GS-2Z
1/8" THICK
BUNA-N RUBBER
100 lb Roll

O-RING CORD

Priced by the foot, O-ring cord is handy to have in case you have to make emergency O-rings in the field.



SSC#	DIAMETER	SSC#	DIAMETER
OC-7000	1/16"	OC-7006	5/16"
OC-7000A	3/32"	OC-7008	3/8"
OC-7001	1/8"	OC-7010	7/16"
OC-7001A	5/32"	OC-7012	1/2"
OC-7002	3/16"	OC-7014	.535"
OC-7004	1/4"	OC-7016	9/16"
OC-7005	9/32"		

O-RING GUIDE/O-RING BOX//MOTOR PARTS

O-RING CORD INSTANT ADHESIVE

Use this adhesive to bond together O-rings. It's good to have on hand in case you don't have the right O-ring in stock. Sold in 3 gram tubes.



OCAD-7025
O-RING CORD
INSTANT ADHESIVE
3 Gram Tube

LAMINATED O-RING SIZING GUIDE

Use this guide to identify any loose O-rings you have lying around. The guide is laminated for protection and all O-rings are shown life size with the SSC number clearly marked.

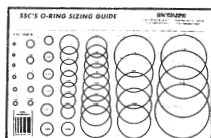

ORG-1
LAMINATED O-RING
SIZING GUIDE
8 Pages

PUMP / MOTOR SHAFT EXTENSIONS

SSC's pump shaft extensions are made of solid brass which ensures durability in a harsh environment. Stainless steel set screws are included and some shafts may fit pumps other than the ones listed.



E-6501
AMERICAN (397013)

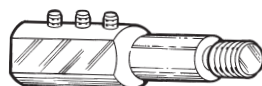

E-6502
PREMIER; AQUA-FLO AF6;
STA RITE (C110-17)

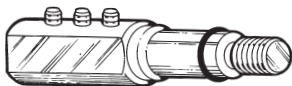

E-6503
SWIMRITE; PREMIER P-8,
104, 475 (31-814);
POLARIS P-45



E-6504
PAC FAB (35-3750)

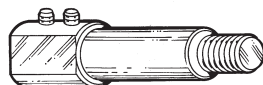

E-6505
JACUZZI (07-3610-09)

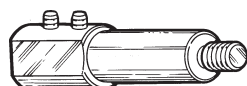

E-6506
SWIMQUIP (16800-29)



E-6510
SET SCREW FOR
SHAFT EXTENSION
Stainless Steel

SMALL SIZED O-RING BOX

This kit contains the 24 most popular small sized O-rings for the Pool & Spa industry (2 3/4" OD and less). Each O-ring is identified with the SSC part number. Reference your SSC catalog to see the multiple listings for each O-ring.

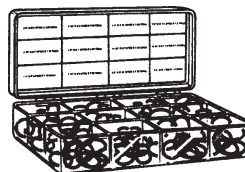

O-9000
SMALL SIZED O-RING BOX
24 different sizes. 10 of each
size O-ring for a total of 240
O-rings in this kit.

PACKED IN A SHATTER PROOF
PLASTIC BOX WITH 24 COMPARTMENTS

MOTOR PARTS TO FIT A.O. SMITH

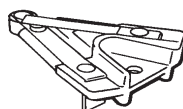

301100
STATIONARY SWITCH
Single Speed

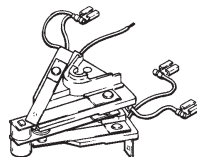

301102
STATIONARY SWITCH
Two Speed



301104
TERMINAL BOARD

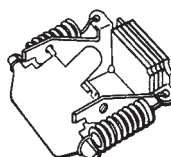

301106
ROTATING SWITCH
Single Speed

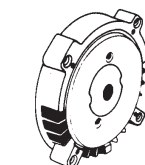

301108
ROTATING SWITCH
Two Speed

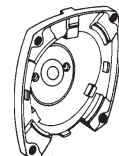

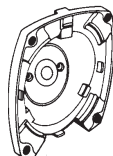

301112
S.E. END BELL-
ROUND BODY
Uses 203 Bearing



301114
S.E. END BELL-
SQUARE FLANGE
Uses 203 Bearing

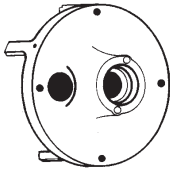
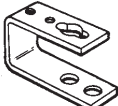
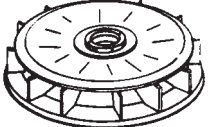
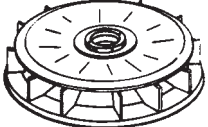

If we are missing the motor part you need let us know and we'll try to get it.

	301118 O.S.E. END BELL Uses 203 Bearing
	301120 BRACKET
	301122 INTERNAL COOLING FAN 25/32" ID x 4 3/4" OD (SHOWN)
	301126 INTERNAL COOLING FAN 21/32" ID x 4 11/16" OD
	301128 BACK COVER

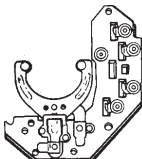
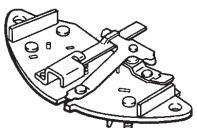
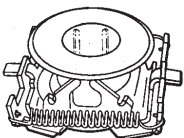
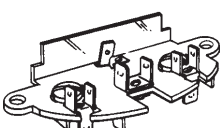
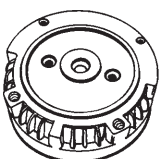
MOTOR PARTS TO FIT CENTURY

	301200 STATIONARY SWITCH Single Speed
	301202 STATIONARY SWITCH Single Speed
	301204 ROTATING SWITCH Single Speed
	301206 TERMINAL BOARD PSC Design
	301208 S.E. END BELL- ROUND BODY Uses 304 Bearing

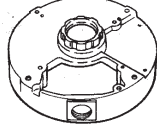
MOTOR PARTS FOR CENTURY / G.E.

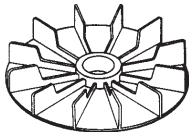
	301212 O.S.E. END BELL Uses 203 Bearing
	301214 TERMINAL BOARD COVER
	301216 INTERNAL COOLING FAN 21/32" ID x 4 3/4" OD

MOTOR PARTS TO FIT GENERAL ELECTRIC

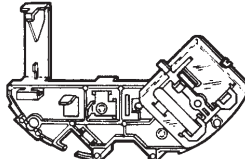
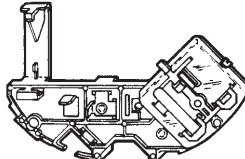
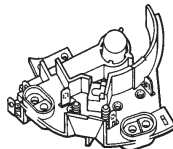
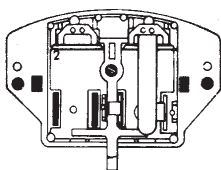
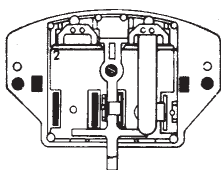
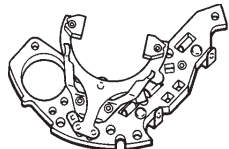
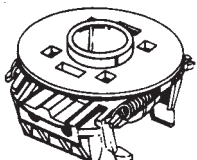
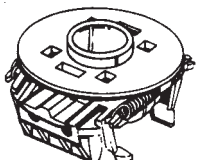
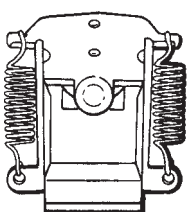
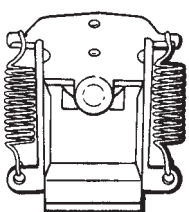
	301300 STATIONARY SWITCH Single Speed
	301302 STATIONARY SWITCH Two Speed
	301306 STATIONARY SWITCH Two Speed
	301308 STATIONARY SWITCH Single Speed
	301310 STATIONARY SWITCH Two Speed
	301312 STATIONARY SWITCH Single Speed
	301316 ROTATING SWITCH Single Speed
	301318 ROTATING SWITCH Two Speed
	301320 ROTATING SWITCH Single Speed
	301322 ROTATING SWITCH Two Speed

MOTOR CAPACITORS

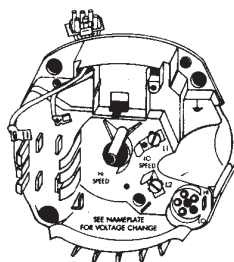

301324
 BASE PLATE-INCLUDES
 QUICK DISCONNECT
 PLUG AND TERMINALS
 Single Speed

301326
 BASE PLATE-INCLUDES
 QUICK DISCONNECT
 PLUG AND TERMINALS
 Two Speed

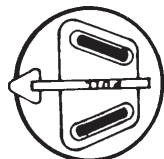

301328
 VOLTAGE CHANGE PLUG

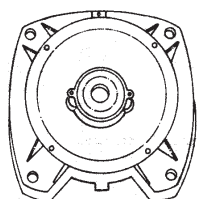

301330
 S.E. END BELL-
 SQUARE FLANGE
 Uses 203 Bearing

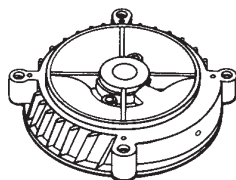

301334
 S.E. END BELL-
 ROUND BODY
 Uses 203 Bearing

301336
 S.E. END BELL-
 ROUND BODY
 Uses 204 Bearing

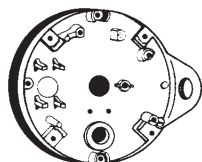

301338
 O.S.E. END BELL
 Uses 203 Bearing

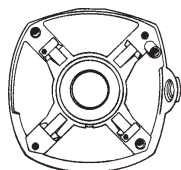

301340
 O.S.E. END BELL
 Uses 203 Bearing

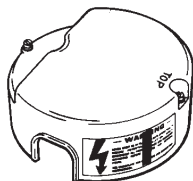

301342
 BACK COVER-2 SCREWS
 Single Speed

301344
 BACK COVER-2 SCREWS
 Two Speed

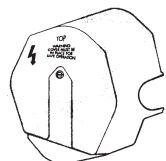

301346
 BACK COVER-
 SINGLE SCREW

MOTOR START AND RUN CAPACITORS



START CAPACITORS

125 Volt AC - 60 Cycle

SSC#	MFD	DIAMETER	HEIGHT
MC-510	72-78	1 7/16"	2 3/4"
MC-511	88-108	1 7/16"	2 3/4"
MC-512	108-130	1 7/16"	2 3/4"
MC-513	124-149	1 7/16"	2 3/4"
MC-514	145-175	1 7/16"	2 3/4"
MC-515	161-193	1 7/16"	2 3/4"
MC-516	189-227	1 7/16"	2 3/4"
MC-517	200-240	1 7/16"	2 3/4"
MC-518	243-292	1 7/16"	2 3/4"
MC-519	270-324	1 7/16"	2 3/4"
MC-520	324-388	1 13/16"	2 3/4"
MC-521	340-408	1 13/16"	3 3/8"
MC-522	378-440	1 13/16"	3 3/8"
MC-523	400-480	1 13/16"	3 3/8"
MC-524	460-552	1 13/16"	3 3/8"
MC-525	540-648	1 13/16"	3 3/8"

RUN CAPACITORS

370 Volts - Round
 Metallized Film - Motor Run

SSC#	MFD	DIAMETER	HEIGHT
MC-540	25	1 3/4"	2 7/8"
MC-541	30	1 3/4"	2 7/8"

CAPACITOR TO FIT AQUA FLO MOTORS



MC-535
 START CAPACITOR
 TO FIT AQUA FLO
 36-43 MFD
 220 VOLTS

CAPACITOR TO FIT MAGNETEC MOTORS



MC-537
 START CAPACITOR
 TO FIT MAGNETEC
 35UF, 370 VAC
 Magnetec #005-1479-RMF

CAPACITOR TO FIT GENERAL ELECTRIC MOTORS



MC-536
 START CAPACITOR
 TO FIT G.E. MOTORS
 53-64 MFD
 220 VOLTS

BALL BEARINGS

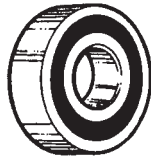

SSC's single row deep groove ball bearings have double, non-contact seals with a high temperature lubricant. They provide quiet, long-life performance with minimum vibration for most electric motors.

SSC#	I.D. (BORE)		OD		WIDTH	
6202	.591"	15mm	1.378"	35mm	.433"	11mm
6202-16	.629"	16mm	1.378"	35mm	.433"	11mm
6203	.669"	17mm	1.574"	40mm	.472"	12mm
6203-625	.625"	15.875mm	1.574"	40mm	.472"	12mm
6204	.787"	20mm	1.854"	47mm	.551"	14mm
6205	.984"	25mm	2.047"	52mm	.590"	15mm
6206	1.181"	30mm	2.440"	62mm	.629"	16mm
6207	1.378"	35mm	2.834"	72mm	.669"	17mm
6303	.669"	17mm	1.854"	47mm	.551"	14mm
6304	.787"	20mm	2.047"	52mm	.590"	15mm

6202 BEARING WILL FIT:

- Older General Electric motors for above ground pumps such as Lomart and Ampro.
- Older Westinghouse motors for above ground pumps such as Lomart and Ampro.

6202-16MM BEARING WILL FIT:

- Newer General Electric motors for above ground pumps.
- Newer Westinghouse motors for above ground pumps.

6203 BEARING WILL FIT:

- A.O. Smith 1/2 HP-1 HP rear end and shaft end 48 frame.
- A.O. Smith 1/2 HP-3 HP rear end.
- Century 1/2 HP-3 HP rear end.
- Century Poolsweep 3/4 HP rear and shaft end.
- Century Spa 1/2 HP-1 HP rear end and shaft end.
- General Electric 1 HP on both ends.
- General Electric 1 1/2 HP-3 HP rear end.
- Franklin 1/2 HP-3 HP rear end.
- Franklin Spa 1/2 HP-1 HP rear and shaft end.
- Polaris 3/4 HP rear and shaft end.

6203-625 (5/8") BEARING WILL FIT:

- Emerson motors since 1974.
- Some above ground pumps such as Lomart.

6204 BEARING WILL FIT:

- A.O. Smith 1 1/2 HP-3 HP shaft end-48 frame.
- General Electric 1 1/2 HP and up-for shaft end only.

6304 BEARING WILL FIT:

- A.O. Smith 1 HP-3 HP rear end and shaft end-48 frame.
- Century 1/2 HP-3 HP shaft end.
- Franklin on pump end.
- Franklin 1/2 HP-3 HP shaft end.

MOTOR BEARING PULLER

This is a special two armed puller designed to fit behind all pool motor bearings, eliminating the need for bearing puller adapters.

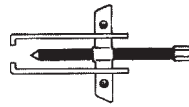

ST-377
MOTOR BEARING PULLER

ARMATURE HOLDING TOOL

This tool holds old style Century and Franklin armatures so the impeller can be removed. It fits into a 5/8" socket wrench.

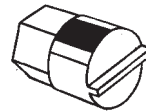

ST-375
ARMATURE HOLDING TOOL

SHAFT PULLER

Our Shaft Puller allows for easy removal of seal shaft extensions from keyed shaft pump motors. Can be used on Sta Rite, H&F, Pac Fab, American, Premier, Aqua Flo and Anthony motors.

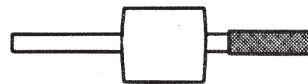

ST-376
SHAFT PULLER

CLOSED IMPELLER WRENCH



ST-362
CLOSED IMPELLER WRENCH
Fits all closed impellers. It has a large handle for leverage

OPEN IMPELLER WRENCH



ST-361
OPEN IMPELLER WRENCH
Fits all open-faced impellers

IMPELLER WEDGE

This tool was designed especially for spa booster pumps. It prevents the impeller from moving as you unscrew the impeller by turning the motor armature counter clockwise.

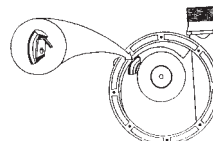

ST-378
IMPELLER WEDGE

BUMP SHAFT RETAINER C-CLIP



STAINLESS STEEL

E-6600
BUMP SHAFT RETAINER
C-CLIP TO FIT HAYWARD
PERFLEX DE FILTERS
Replaces: ECX1014
Stainless Steel

SERVICE TOOLS

SLICK PICK IMPELLER CLEANER

This efficient device allows the service technician to reach the closed impeller face without disassembling the entire pump. Simply turn off the pump and remove the pump lid and lint basket. Insert the opened "pick" and probe for debris using the wire end.



ST-371
"SLICK PICK"
IMPELLER CLEANER

SEAL SETTING TOOL

This makes setting seals a snap. Works on pumps up to 3 HP.



ST-379
SEAL SETTING TOOL

EYEBALL SEAT REMOVAL TOOLS

These tools remove and install 1 1/2" grooved eyeballs (flow fittings) with very little difficulty. They make burdensome eyeball removal a snap.



STEEL
ST-369
EYEBALL SEAT
REMOVAL TOOL
Made of Forged Steel

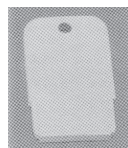

NO RIPPED LINERS WHEN THE PLASTIC ONE IS DROPPED!

PLASTIC
ST-358
EYEBALL SEAT
REMOVAL TOOL
Made of Molded Plastic
Replaces Hayward
#SPX1419T

POLARIS/LETRO WALL FITTING REMOVAL TOOL

This tool allows you to remove the pool cleaner fitting even if the lock tabs on the sides are broken off.



ST-382
POLARIS/LETRO WALL
FITTING REMOVAL TOOL
Made of Forged Steel

WATERWAY JET RETURN FACEPLATE TOOL

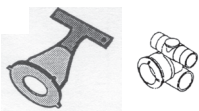

ST-383
WATERWAY JET
FACEPLATE TOOL

If we are missing the tool you need let us know and we'll try to make it.

LOCK NUT WRENCH FOR SOCKETS

Use this handy tool with the sockets listed below to tighten and remove wall fitting nuts.



ST-386
LOCK NUT WRENCH
FOR SOCKETS

SOCKET FOR ABOVE WRENCH TO FIT HAYWARD 3109

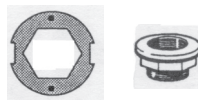

ST-386A
SOCKET TO FIT
HAYWARD 3109

SOCKET FOR ABOVE WRENCH TO FIT HAYWARD IN-GROUND 3110



ST-386B
SOCKET TO FIT HAYWARD
IN-GROUND 3110

SOCKET FOR ABOVE WRENCH TO FIT WATERWAY



ST-386C
SOCKET TO FIT
WATERWAY

SOCKET FOR ABOVE WRENCH TO FIT PENTAIR (PAC FAB)

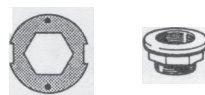

ST-386D
SOCKET TO FIT
PAC FAB (PENTAIR)

SPA JET CLEANER TOOL

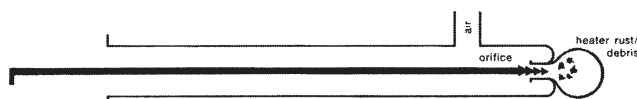

ST-390
SPA JET CLEANER TOOL

PLASTIC D.E. SCOOP - 1 LB

ORANGE
COLOR



ST-367
1 LB D.E. SCOOP

SAFETY COVER ALLEN WRENCH DRILL BITS

Put these bits in your drill to speed up the onerous task of tightening or loosening safety cover anchors. 26" long.



SSC#	SIZE
ST-384	3/16"
ST-385	1/4"

O-RING PULLER TOOL

Save those fingers! This inexpensive tool makes O-ring removal fast and easy.



O-10950
O-RING PICK

BRASS CLEANING BRUSH



SSC-78BR
BRASS CLEANING BRUSH
Hickory Handle
Toothbrush Size

GASKET CUTTING SHEARS

These shears make gasket cutting easy, especially when working with thick material. The design also allows for an accurate cut.



GS-100SH
HEAVY-DUTY SHEARS FOR
CUTTING GASKET MATERIAL

**INSIDE PVC PIPE CUTTER
AND EXTRA WHEELS**

This tool allows the service technician to cut 2" and larger pipe from the inside of the pipe. Just place this tool in your drill and start cutting!

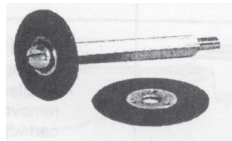

ST-387
INSIDE PVC PIPE CUTTER
Cuts 2" and Larger Pipe
ST-387W
3 EXTRA WHEELS
FOR INSIDE PVC
PIPE CUTTER

PVC WIRE SAW

The PVC wire saw is perfect for tight spots (only needs 1/4" clearance) and quick cuts. It easily cuts through water filled pipes.



ST-365
PVC WIRE SAW

ANCHOR REPAIR PLATE

Our Anchor Repair Plate eliminates the need to replace broken deck anchors. This handy tool allows the wedge to be tightened up against the rail.

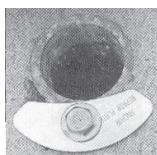

ST-366
ANCHOR REPAIR PLATE

LIGHT WEDGE

This handy tool holds the pool light in when the niche tab is stripped or broken.

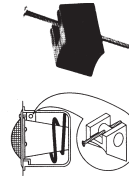

ST-374
LIGHT WEDGE
Made of corrosion
resistant polypropylene
with a stainless steel screw.

CORD STOPPERS

These rubber plugs fit around power cords.

FOR RETROFIT - WITH SLIT



PART#	SIZE	DESCRIPTION
ST-380	3/4" NICHE	REGULAR
ST-381	1" NICHE	REGULAR
ST-394	3/4" NICHE	FOR 12 VOLT
ST-395	1" NICHE	FOR 12 VOLT
ST-398	1" NICHE	2 HOLE-FOR BONDING GROUND

FOR NEW INSTALLATION - No Slit



PART#	SIZE	DESCRIPTION
ST-392	3/4" NICHE	FOR NEW INSTALLATION
ST-393	1" NICHE	FOR NEW INSTALLATION
ST-396	3/4" NICHE	FOR 12 VOLT
ST-397	1" NICHE	FOR 12 VOLT
ST-399	1" NICHE	2 HOLE-FOR BONDING GROUND

ANTI-ELECTROLYSIS ZINC PLATE

This product stops metal erosion and plaster discolorization due to electrolysis. It also functions as a weight to keep skimmer baskets in place.



ST-359
ANTI-ELECTROLYSIS
ZINC PLATE
Bolts Inside or Outside of
any Skimmer Basket

LID REMOVING TOOL

This tool is specially designed to remove Sta Rite, American Products, Swim-Quip and Hayward strainer lids with ease.

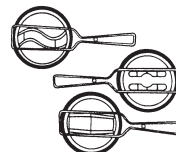

ST-360
LID REMOVING TOOL
Made of Zinc Plated
Steel

TOOLS / TEFLON PRODUCTS / LUBRICANTS

MAGNETIC POLE TIP

Use this tool to pick up bobby pins and other metal objects that are too small to be scooped up by your net and that would otherwise cause ugly, hard-to-remove rust stains.

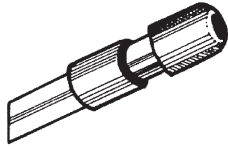

ST-372
MAGNETIC POLE TIP
 Made of durable plastic with a built-in ceramic magnet. Will not corrode.

SCHRADER VALVE

This bicycle type air valve allows the service technician to enter air into any system with a compressor or hand pump. It's handy for pressure testing tanks, plumbing systems, pipe, etc.



107140
SCHRADER VALVE
 1/8" NPT

TEFLON TAPE

REGULAR TEFLON TAPE

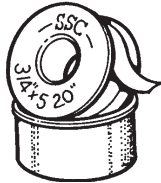

.003" THICK

SSC#	SIZE
TT-312	3/4" X 520"
TT-314	1" X 520"
TT-315	1/2" X 260"
TT-316	1/2" X 520"

YELLOW GAS SEAL TEFLON TAPE

Our Yellow Gas Seal Teflon Tape is UL approved, has 1.6" density and is .004" thick. This extra heavy duty tape is made especially for natural gas, propane, butane, water, oil and chemical lines.



.004" THICK

SSC#	SIZE
TT-324	1/2" X 260"
TT-325	1/2" X 520"
TT-326	3/4" X 520"

TEFLON PASTE (PIPE DOPE)



TT-319
TEFLON PASTE (PIPE DOPE)
 1/2 Pint W/ith Brush Top

TEFLON LUBRICANT

The U.S.D.A. has rated this lubricant as Food Grade Acceptable. Safely lubricate O-rings, seals, bearings, valves, gears, faucet components and more. This is a waterproof, non-melting, pure synthetic grease which will seal out water and lubricate under the most adverse conditions.



3 OZ. TUBE

LUB-985
TEFLON LUBRICANT/ SEALANT
 U.S.D.A. H-1 Rated

COMBINATION TEFLON / SILICONE LUBRICANT

The LUB-986 lubricates and seals with a patented barrier of silicone and teflon. The U.S.D.A. has rated this lubricant as Food Grade Acceptable. It will not melt, dry out, form gummy deposits, separate, crack, evaporate, run or drip. It will safely lubricate O-rings, seals, bearings, valves, gears, faucet components and more.



4 OZ. TUBE

LUB-986
COMBINATION TEFLON/SILICONE LUBRICANT
 U.S.D.A. H-1 Rated

SILICONE LUBRICANT

SSC's Silicone Lube has similar uses as the teflon lube except that it is silicone based, making it a higher grade product than the teflon. It is also rated as Food Grade Acceptable by the U.S.D.A.

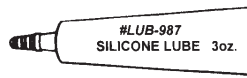

3 OZ. TUBE

LUB-987
SILICONE LUBRICANT/ SEALANT
 U.S.D.A. H-1 Rated

SILICONE BASED SPRAY LUBRICANT

A coating of this food-grade rated spray lubricant will protect everything from O-rings to nuts and bolts. The superior and safe lubrication properties of silicone are packaged here in a spray for a cleaner and easier application.



4 OZ. SPRAY BOTTLE

LUB-989
SILICONE BASED SPRAY LUBRICANT

Our Consolidated O-ring list on pgs. 39-51 will save you money. Check out these listings which show how one O-ring will fit many different applications. See how an O-ring for one OEM's filter will fit another's pump.



LUBRICANTS / DUCT & ELECTRICAL TAPE

ZOOM-SPOUT OILER

Use the high quality turbine oil in SSC's Zoom-Spout Oiler to oil electric motors, heaters, blowers, bushings, shafts, air-conditioners and home and shop appliances. The handy telescoping pole reaches into hard-to-get places.



ZM-322
ZOOM-SPOUT OILER
4oz. Tubes With
Zoom-Spout

STICKY SPRAY

Sticky Spray is a convenient way to hold O-rings and gaskets in place during installation. Spray the surface where you are installing the part, wait 1-2 minutes until it becomes tacky and apply the part. The part can easily be separated from the surface at a later date. This product works especially well in troublesome installations such as putting spoke gaskets in multiport valves or cover gaskets in Hayward Super Pumps.



LUB-990
STICKY SPRAY
4oz. Spray Bottle

GASKET REMOVING SOLUTION

Make the removal of stubborn, baked-on gaskets easy. With this product's foaming action you can remove gaskets without the work and without damage to the part. Sold in 18 oz. spray cans.



GR-957
GASKET REMOVING
SOLUTION
18 oz. Spray Can

**FIBERGLASS TAPE KIT-
USED TO REPAIR PIPES & HOSES**

Use our tape kit to repair broken pipe and hose. Just add water to the tape and wrap the broken area of pipe. Let it cure and the hole is patched. Rated at 300+ psi, -60° F to 800° F. It can be used on all types of pipe--plastics, poly, metal and copper.



SW-350
FIBERGLASS TAPE
PIPE & HOSE
REPAIR KIT
2" Wide x 60" Long

DUCT TAPE

GRAY



DT-317
GRAY COLORED
DUCT TAPE
2" x 60yds.
Each Roll is
Shrink-Wrapped
For Protection

BLACK



DT-320
BLACK COLORED
DUCT TAPE
2" x 50 yds.
Each Roll is
Shrink-Wrapped
For Protection

DUCT TAPE - VARIOUS COLORS



2" X 50 YDS

SSC#	COLOR
DT-320W	WHITE
DT-320B	BLUE
DT-320R	RED
DT-320G	GREEN
DT-320Y	YELLOW
DT-320D	DARK GREEN

ALUMINUM FOIL TAPE

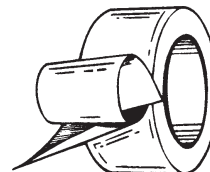

EACH ROLL IS
SHRINK-WAPPED
FOR PROTECTION

SSC#	SIZE
DT-318	2" W x 50 yds.
DT-318A	3" W x 60 yds.

ELECTRICAL TAPE



3/4" W X 60' L
UL APPROVED

SSC#	COLOR
ET-323	BLACK
ET-323B	BLUE
ET-323G	GREEN
ET-323Y	YELLOW
ET-323W	WHITE
ET-323R	RED

SSC's Pump Repair and Service Kits (Go-Kits) make it quick and easy to service pumps. We eliminate the guesswork sometimes needed when getting the right parts together for pump repair or service. All are skin-packed for display and bar-coded. See pgs. 73-75.

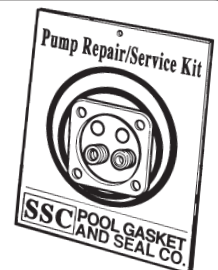

SERVICE ACCESSORIES

DISPOSABLE VINYL GLOVES



PACKED 100/BOX

Our vinyl disposable gloves are an economical way to protect the hands from dirt, grease and other harmful chemicals while working in the field. They can be thrown out after each job or used over and over.

GL-627
DISPOSABLE VINYL
GLOVES
Medium Size

GL-628
DISPOSABLE VINYL
GLOVES
Large Size

DUST MASKS

Use these economical dust masks for protection against chemicals and undesirable odors while servicing pools and spas or while doing general service work.



PACKED 50/BOX

108510
DUST/PARTICLE MASK

ROUGH SERVICE BULBS

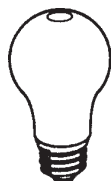

PACKED 4/PACKAGE

LB-608A
ROUGH SERVICE BULB
75 Watt

LB-608B
ROUGH SERVICE BULB
100 Watt

RUBBER GROMMETS

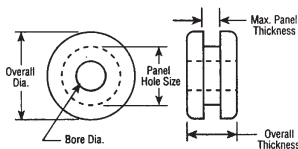

SSC#	BORE DIA.	PANEL HOLE/THICK.	DIA./THICK.
RG-634A	1/8"	1/4" / 1/16"	11/32" / 3/16"
RG-634B	3/16"	5/16" / 1/16"	1/2" / 1/4"
RG-634C	3/16"	5/16" / 3/16"	7/16" / 5/16"
RG-634D	5/16"	7/16" / 1/16"	5/8" / 9/32"
RG-634E	1/2"	1/2" / 1/16"	5/8" / 1/4"
RG-634F	3/8"	3/4" / 3/32"	7/8" / 11/32"
RG-634G	5/8"	7/8" / 1/16"	1 1/8" / 5/16"
RG-634H	3/4"	1 1/16" / 1/16"	1 3/8" / 3/8"
RG-634I	7/8"	1 1/4" / 1/16"	1 5/8" / 7/16"

RUBBER TIE DOWN STRAPS



MADE OF EPDM RUBBER FOR MAXIMUM DURABILITY

SSC#	LENGTH
RS-629A	10"
RS-629B	15"
RS-629C	20"
RS-629D	31"
RS-629E	41"

VIBRO-INSULATORS

Vibro-Insulators are rubber mountings which reduce or prevent the travel of vibrations to or from machinery. They control vibration and reduce noise on electric motors, pumps, compressors, blowers, generators, etc.



VI-633D



VI-633E



VI-633G

SSC#	DESCRIPTION
VI-633A	DOUBLE STUD-1 5/8" DIA.x1 1/2" Hx5/16-18 THR
VI-633B	DOUBLE STUD-1 5/8" DIA.x1"Hx5/16-18 THREAD
VI-633C	DOUBLE FEMALE-1" DIA.x1"Hx5/16-18-24 THR.
VI-633D	DOUBLE STUD-1"DIA.x1"Hx5/16-18 THREAD
VI-633E	DOUBLE STUD-1"DIA.x3/4"Hx1/4-20 THREAD
VI-633F	SINGLE STUD-1 5/8" DIA.x1 1/2"H x5/16-18 THR.
VI-633G	SINGLE STUD-1 5/8" DIA.x1"Hx5/16-18 THREAD

WIRE TIES AND MOUNTS

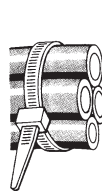

PACKED 100/BAG

SSC#	DESCRIPTION	LENGTH	STRENGTH
WT-625A	WHITE WIRE TIE	4"	18 LBS.
WT-625B	BLACK WIRE TIE	4"	18 LBS.
WT-625C	WHITE WIRE TIE	8"	18 LBS.
WT-625D	BLACK WIRE TIE	8"	18 LBS.
WT-625E	WHITE WIRE TIE	8"	50 LBS.
WT-625F	BLACK WIRE TIE	8"	50 LBS.
WT-625G	WHITE WIRE TIE	12"	50 LBS.
WT-625H	BLACK WIRE TIE	12"	50 LBS.
WT-625I	MNTG WIRE TIE-WH.	8 1/2"	50 LBS.
WT-625J	MNTG WIRE TIE-BL.	8 1/2"	50 LBS.
WT-625K	WIRE TIE MOUNT	3/4"	--
WT-625L	WIRE TIE MOUNT	1"	--
WT-625M	WHITE WIRE TIE	14"	40 LBS.
WT-625N	BLACK WIRE TIE	14"	40 LBS.
WT-625P	WHITE WIRE TIE	28 1/4"	120 LBS.
WT-625R	BLACK WIRE TIE	28 1/4"	120 LBS.

LADDER FOOT BUMPER / LADDER PARTS

LADDER FOOT BUMPER AND KIT

SSC's Ladder Foot Bumper is made of white rubber formulated to withstand the elements. The universal design will fit all major pool ladders.

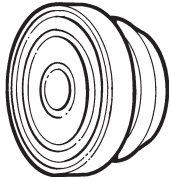

LFB-100
MALE LADDER
FOOT BUMPER
White Rubber

LADDER FOOT BUMPER KIT



LFB-100K
2-PACK OF LADDER
FOOT BUMPERS
Packed in plastic bag
with hanger hole and
label for display.

REPLACEMENT PLASTIC LADDER STEP

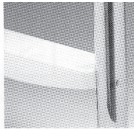

LP-245
PLASTIC LADDER STEP
For 1.9" OD
(Nuts and Bolts Not Included)

POOL WALL STEPS-SET OF 3

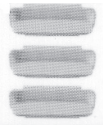

LP-244
POOL WALL STEPS-
SET OF 3
Plastic

HANDRAIL STABILIZING PLUGS

ANCHOR TYPE

When hammered into crushed handrails, it provides a permanent, strong supporting surface for the anchor to tighten against.

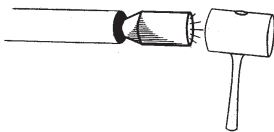

ST-363
HANDRAIL STABILIZING
PLUG-ANCHOR TYPE
Sold by Set

FIGURE 4 TYPE

When tapped into the jig it prevents the jig from collapsing and creates a solid area to tighten the nut and bolt against.



ST-364
HANDRAIL STABILIZING
PLUG-FIGURE 4 TYPE
Sold by Set

LADDER REPLACEMENT PARTS

ALUMINUM WEDGE ANCHOR

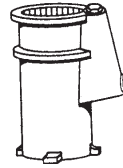

LP-250
WEDGE ANCHOR
SOCKET
4 Inch Aluminum
(Uses Wedge #LP-255)

BRONZE WEDGE ANCHOR

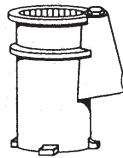

LP-251
WEDGE ANCHOR
SOCKET
4 Inch Bronze
(Uses Wedge #LP-255)

ANCHOR REPAIR PLATE

Our Anchor Repair Plate eliminates the need to replace broken deck anchors. This handy tool allows the wedge to be tightened up against the rail.

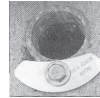

ST-366
ANCHOR REPAIR PLATE

ANCHOR SOCKET COVER

Our Anchor Socket Cover eliminates stubbed toes resulting from open sockets.



LP-232
ANCHOR SOCKET COVER
Bronze

JOHNNY HINGE

Ideal for use on pools with automatic covers, the Johnny Hinge ladder hinge enables anyone to lift the ladder out of the pool and rotate it so it is in a horizontal position. This clears the way for the pool cover. The hinge is hidden from view when the ladder is down and it mounts into all standard anchor sockets.

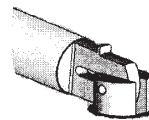

BRONZE

LP-231
JOHNNY HINGE
Fits 1.9" Ladder Rails
Sold in Pairs

1)Raise Escutcheon 2)Lift Ladder 3)Rotate & Lock Ladder

WHITE SLOPING LADDER FLANGE

Use this ladder flange when the mounting surface is sloped. Old Helder Pools is one example of where this can be used.

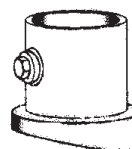

LP-243
SLOPING LADDER
FLANGE
White Aluminum
Fits 1.9" Rails

LADDER PARTS / POOL HARDWARE

IN GROUND FLANGE ANCHOR

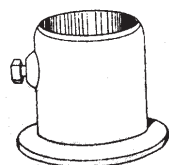

LP-260
LADDER FLANGE ANCHOR
Aluminum
For 1.9" Rail (In Ground)
Hanover #: 24

ABOVE GROUND FLANGE ANCHOR

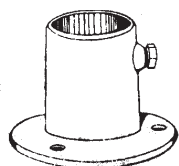

LP-261
LADDER FLANGE ANCHOR
Aluminum
For 1.5" Rail (Above Ground)
Hanover #: 22

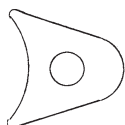

ACTUAL SIZE: 1 1/8" X 1 1/8"

LP-255
WEDGE ASSEMBLY
With Bolt & Washer
Hanover #: 40



ACTUAL SIZE: 15/16" X 5/8"

LP-256
WEDGE ASSEMBLY
With Bolt & Washer
Hanover #: 30



ACTUAL SIZE: 7/8" X 1"

LP-257
WEDGE ASSEMBLY
With Bolt & Washer
For Perma Socket



LP-265
ROUND ESCUTCHEON
Stainless Steel
Fits 1.9" Rail

LP-266
ROUND ESCUTCHEON
White Plastic
Fits 1.9" Rail

LP-267
ROUND ESCUTCHEON
Chrome Plated Plastic
Fits 1.9" Rail



LP-268
KEY HOLE ESCUTCHEON
Chrome Plated Brass
Fits 1.9" Rail

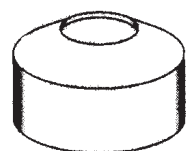

LP-233
EXTRA TALL LADDER ESCUTCHEON
White Aluminum
Fits 1.9" Rail

SLIDE FLANGES

ALUMINUM

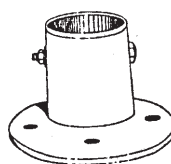

LP-270
WHITE ALUMINUM SLIDE FLANGE
Fits 1.9" Rail
Includes Hardware
Hanover #: 24

PLASTIC

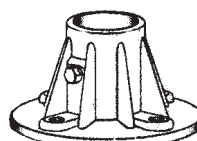

LP-234
WHITE PLASTIC SLIDE FLANGE
Fits 1.9" Rail
Includes Hardware
Hanover #: 24

REPLACEMENT HOOKS



LP-273
1/2" CLEAT TYPE HOOK
FOR SAFETY ROPE
For 1/2" Rope



LP-274
3/4" CLEAT TYPE HOOK
FOR SAFETY ROPE
For 3/4" Rope



LP-275
1/2" LOOP TYPE HOOK
Replaces Hayward #SP-45
Chrome Plated Brass



LP-276
3/4" LOOP TYPE HOOK
Replaces Hayward #SP-47
Chrome Plated Brass









LP-277
S-HOOK
Fits 1/4"-1/2" Rope
Chrome Plated Brass

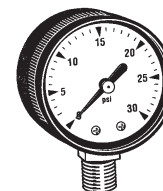





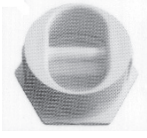
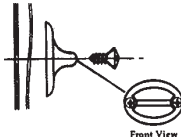
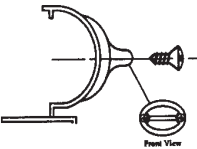

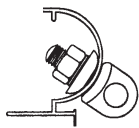
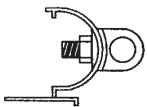

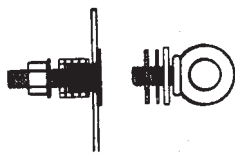
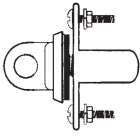
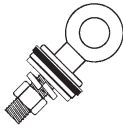
LP-278
S-HOOK
Fits 3/4" Rope
Chrome Plated Brass

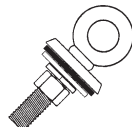
SSC offers over 250 different **Pressure, Compound, Vacuum, Liquid Filled and Water Test Gauges.** We have a wide selection at competitive prices. See pgs. 79-82.

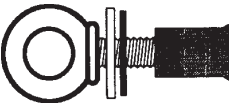
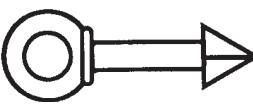

ROPE ANCHORS	
	LP-235 CUP ANCHOR WITH REMOVABLE EYE Chrome Plated Brass
	LP-236 CUP ANCHOR WITH CROSS BAR Chrome Plated Brass
WITH STEEL PIN	
	RA-574 ROPE ANCHOR WITH STEEL PIN TO FIT HAYWARD Replaces: SPX1040 White Plastic
WITH PLASTIC PIN	
	RA-575 ROPE ANCHOR WITH PLASTIC PIN White Plastic
ROPE EYES AND GASKET	
 <small>Front View</small>	LP-290 FLAT OVAL ROPE EYE Chrome Plated Brass Includes Screws Sold by Pair
 <small>Front View</small>	LP-291 CURVED OVAL ROPE EYE FOR COPING MOUNT Chrome Plated Brass Includes Screws Sold by Pair
OVAL ROPE EYE GASKET	
	G-4461 GASKET FOR OVAL ROPE EYE
	LP-240 COPING ROPE EYE WITH STUD Chrome Plated Brass Includes Screws
 <small>SOLD BY PAIR</small>	LP-295 COPING ROPE EYE WITH STUD Chrome Plated Brass Includes Screws

ROPE ANCHORS, EYES AND CLAMPS	
	LP-292 VINYL POOL ROPE EYE Designed for a positive seal with no wrinkling of the liner. Brass with Stainless Steel Fasteners
	LP-239 REMOVABLE ROPE EYE FOR VINYL LINERS Chrome Plated Brass
	LP-241 REMOVABLE ROPE EYE FOR VINYL LINERS Chrome Plated Brass
 <small>WITH 2" STUD</small>	LP-242 REMOVABLE ROPE EYE FOR VINYL LINERS WITH 2" STUD Chrome Plated Brass
	LP-238 STANDARD 7/8" ROPE EYE Chrome Plated Brass
	LP-237 ROPE EYE WITH LAG SHEILD Chrome Plated Brass
	LP-293 THREADED ROPE EYE WITH LEAD SLEEVE 7/8" Drill Wall Chrome Plated Brass
	LP-294 ARROW ROPE EYE For Concrete Pools Chrome Plated Brass
ROPE CLAMPS	
	LP-281 1/2" ROPE CLAMP Chrome Plated Brass
	LP-280 1/4" ROPE CLAMP Chrome Plated Brass
	LP-282 3/4" ROPE CLAMP Chrome Plated Brass

SAFETY COVER HARDWARE / PLUGS

SAFETY COVER HARDWARE



SCH-430
7" STAINLESS STEEL
COVER SPRING
302 Stainless Steel
One side hooks onto brass
anchor; other side connects
to strap buckle.

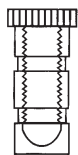

SCH-435
CONCRETE BRASS
ANCHOR
3/4" Dia. x 1.63" L
Has screw body.
Fits into concrete.



SCH-436
WOOD DECK ANCHOR
Has screw body.
Screws into wood deck.



SCH-440
18" LONG ALUMINUM TUBE
(HOLLOW ROD)
Put this tube in less stable
surfaces such as unmortared
brick and stone. The brass
anchor can then be tapped
into this.



SCH-441
18" ALUMINUM STAKE
1/2" Diameter
For grass or dirt surfaces.
Spring hooks directly onto this.

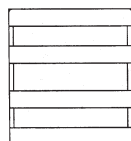

SCH-445
STAINLESS STEEL
BUCKLE
Connects strap on
cover to spring.

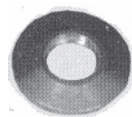

SCH-446
BRASS LAG COLLAR
Hides imperfections in the
concrete surrounding the
anchor made by drill.

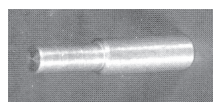

SCH-448
ALUMINUM TAMPING TOOL
Safely drives brass anchor
into concrete.

If we are missing any Safety Cover Hardware that you need, let us know and we'll try to get it.

BUMP SHAFT RETAINER C-CLIP



STAINLESS STEEL

E-6600
BUMP SHAFT RETAINER
C-CLIP TO FIT HAYWARD
PERFLEX DE FILTERS
Replaces: ECX1014
Stainless Steel

AIR BLEEDER VALVES / DRAIN COCKS

Some common uses are to release air from Pool & Spa filters
and water from pool heaters.

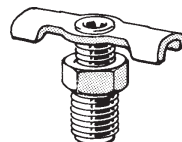

BRASS

SSC#	SIZE
122070	1/8"
122072	1/4"
122074	3/8"

SOLID BRASS PLUGS

Use SSC's solid brass plugs for plugging air-relief valves,
drain openings etc. Similar to our drain cocks except solid.

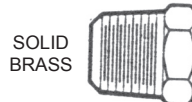

SOLID
BRASS

SSC#	SIZE
122080	1/8"
122082	1/4"
122084	3/8"

SMALL SIZED O-RING BOX

This kit contains the 24 most popular small sized O-rings for
the Pool & Spa industry (2 3/4" OD and less). Each O-ring is
identified with the SSC part number. Reference your SSC
catalog to see the multiple listings for each O-ring.

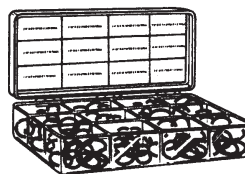

O-9000
SMALL SIZED O-RING BOX
24 different sizes. 10 of each
size O-ring for a total of 240
O-rings in this kit.

PACKED IN A SHATTER PROOF
PLASTIC BOX WITH 24 COMPARTMENTS

TEST PLUG FOR PRESSURE TESTING

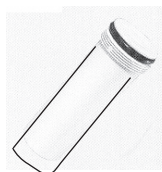

WP-22
TEST PLUG FOR
PRESSURE TESTING
FITS HAYWARD
Replaces: SPX1434TP

VENTED PLUG



WP-23
VENTED PLUG WITH
PERFORATED VENT
2" SP or 1 1/2" SP
Fits 1 1/2" or 2" U-Bend

WINTERIZING PLUGS

MOLDED PLASTIC WINTERIZING PLUGS WITH O-RING

RAISED



WP-20
 RAISED WINTERIZING
 PLUG WITH O-RING
 Made of Molded Plastic
 Replaces: Hayward SPX1022C



O-2115
 O-RING FOR RAISED &
 FLUSH WINTERIZING PLUGS
 Replaces: Hayward SPX1022C

FLUSH



WP-21
 FLUSH WINTERIZING
 PLUG WITH O-RING
 Made of Molded Plastic
 Replaces: Hayward SPX1022B

WINTERIZING EXPANSION PLUGS

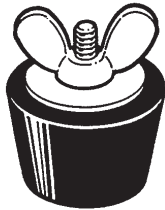

Our Winterizing Plugs are made of a high quality rubber for maximum expandability which ensures a tight seal. These plugs are perfect for pressure testing the system for leaks as well normal winterizing applications. They are made of a stainless steel slotted screw, washers, rubber plug and nylon wing nuts for easy tightening.

SSC#	DIAMETER	FITS
WP-000	.46"	3/8" PIPE
WP-00	.54"	1/2" PIPE
WP-0	.63"	1/2" PIPE
WP-1	.70"	1.2" PIPE
WP-2	.75"	3/4" PIPE
WP-3	.89"	3/4" PIPE
WP-4	.96"	3/4" FITTING & 1" PIPE
WP-5	1.02"	1" TUBE
WP-6	1.20"	1" FITTING
WP-7	1.39"	1 1/4" PIPE
WP-8	1.54"	1 1/2" PIPE
WP-9	1.69"	1 1/4" FITTING & 1 1/2" PIPE
WP-9 1/2	1.73"	1 1/2" WALL FITTING
WP-9 3/4	1.78"	1 1/2" WALL FITTING
WP-10	1.89"	1 1/2" FITTING
WP-11	2.13"	2" PIPE
WP-12	2.42"	2" FITTING
WP-13	2.58"	2 1/2" PIPE
WP-14	3.40"	3" PIPE
WP-15	3.86"	4" PIPE
WP-16	4.64"	4" PIPE

BLOW THRU WINTERIZING PLUGS

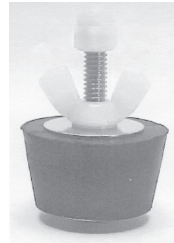

These plugs allows the service technician to release pressure from the pipe or fitting without removing the entire plug. Blow Thru Winterizing Plugs are made of a rubber plug, nylon wing nut and cap, stainless steel washers and a hollow brass blow thru slotted screw.

SSC#	DIAMETER	FITS
WP-2BT	.75"	3/4" PIPE
WP-3BT	.89"	3/4" PIPE
WP-4BT	.96"	3/4" FITTING & 1" PIPE
WP-5BT	1.02"	1" TUBE
WP-6BT	1.20"	1" FITTING
WP-7BT	1.39"	1 1/4" PIPE
WP-8BT	1.54"	1 1/2" PIPE
WP-9BT	1.69"	1 1/4" FITTING & 1 1/2" PIPE
WP-10BT	1.89"	1 1/2" FITTING
WP-11BT	2.13"	2" PIPE
WP-12BT	2.42"	2" FITTING
WP-13BT	2.58"	2 1/2" PIPE

EXTENDED WINTERIZING PLUGS



Extended Winterizing Plugs allow you to locate the plug deeper into the pipe or fitting thus ensuring a positive seal. They are made of a rubber plug, nylon wing nut, stainless steel washers, slotted screw and 1.625" extension.

SSC#	DIAMETER	FITS
WP-2X	.75"	3/4" PIPE
WP-3X	.89"	3/4" PIPE
WP-4X	.96"	3/4" FITTING & 1" PIPE
WP-5X	1.02"	1" TUBE
WP-6X	1.20"	1" FITTING
WP-7X	1.39"	1 1/4" PIPE
WP-8X	1.54"	1 1/2" PIPE
WP-9X	1.69"	1 1/4" FITTING & 1 1/2" PIPE
WP-10X	1.89"	1 1/2" FITTING
WP-11X	2.13"	2" PIPE
WP-12X	2.42"	2" FITTING
WP-13X	2.58"	2 1/2" PIPE

UNIVERSAL WINTERIZING PLUGS AND UNIVERSAL BLOW THRU PLUGS

These plugs are made of the same material described above and fit the range of sizes listed below.

UNIVERSAL PLUGS		UNIVERSAL BLOW THRU	
SSC#	FITS	SSC#	FITS
WP-1-5UP	1 to 5	WP-1-5UPBT	1 to 5
WP-5-7UP	5 to 7	WP-5-7UPBT	5 to 7
WP-7-10UP	7 to 10	WP-7-10UPBT	7 to 10



STEP GASKET / STAIR / SKIMMER SCREWS

TEST PLUGS (DOLLAR PLUGS)



GALVANIZED STEEL FLANGE
MOLDED RUBBER GASKET

SSC#	PIPE SIZE
110202	1 1/2"
110204	2"
110206	3"
110208	4"

STEP SECTION GASKET FOR VINYL LINER POOLS

These 1 1/2" wide x 16' long strips of neoprene rubber will seal the step section under the liner on inground pool installations. Packaged in coils for easy storage on service truck.



SG-200
STEP SECTION
GASKET
1 1/2" Wide x 16' Long
Packed in Coils

STAINLESS STEEL STAIR SCREWS



PACKED 100/BAG

SCR-425
STAINLESS STEEL
STAIR/STEP SCREWS
Packed 100/Bag

STAINLESS STEEL TEK SCREWS (SELF-DRILLING)



PACKED 100/BAG

SCR-427
STAINLESS STEEL
TEK SCREWS
Self Drilling
Packed 100/Bag

A Picture is Worth a Thousand Words...

Our Gasket Picture Guide (pgs. 60-70) shows all of the gaskets we offer in SSC# order. Gasket dimensions are also included for proper identification.

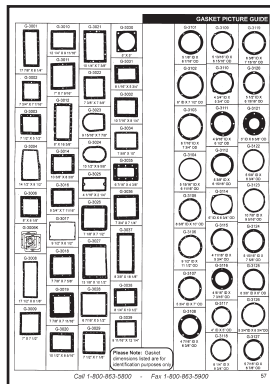

SHEET METAL SCREWS



- #8 thread
- Self piercing
- Hard steel--zinc plated
- Hex head type with screwdriver slot

PACKED 100/BOX

SSC#	SIZE	PACKAGE TYPE
SH-635A	1/2"	100/BOX
SH-635B	3/4"	100/BOX
SH-635C	1"	100/BOX

REPLACEMENT STAINLESS STEEL SKIMMER SCREWS

REGULAR SIZE - 1"



SCR-410
STAINLESS STEEL
SKIMMER SCREWS
Regular Size-1" Long
Packed in a plastic bag
with hanger hole and
label for display
Replaces: SPX1084-Z-4A
and others
PACKAGE OF 12

SCR-412
STAINLESS STEEL
SKIMMER SCREWS
Regular Size-1" Long
PACKAGE OF 100
(BULK PACK)

LONG SIZE - 1 1/4"



SCR-420
STAINLESS STEEL
SKIMMER SCREWS
Long Size-1 1/4" Long
Packed in a plastic bag
with hanger hole and
label for display
Replaces: SPX1030-1C
and others
PACKAGE OF 12

SCR-422
STAINLESS STEEL
SKIMMER SCREWS
Long Size-1 1/4" Long
PACKAGE OF 100
(BULK PACK)

Please Note:

- Our 1" skimmer screw (#SCR-412) can also be used for **main drains**.
- Our 1 1/4" skimmer screw (#SCR-422) can also be used on **Hayward Lights**.

SKIMMER FACEPLATES / AQUADOR

AQUADOR SNAP-ON SKIMMER CLOSURE SYSTEM

The Aquador will save you time and money. When using Aquador you'll never have to lower the water level again when you close a pool for the winter or conduct repair work on a filter. The unique, easy to install design features a snap-on/snap-off lid which will remain flexible to 80° below zero temperatures.

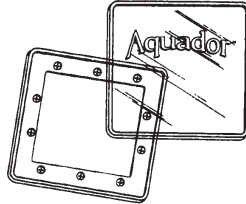

SSC#	DESCRIPTION
AQ-390	FACEPLATE AND LID FOR 1090 (AQ-390 Actual Size: 8 1/4" x 8")
AQ-390L	LID ONLY FOR 1090
AQ-391	FACEPLATE AND LID FOR A/G WIDEMOUTH (AQ-391 Actual Size: 14" x 7 5/8")
AQ-391L	LID ONLY FOR A/G WIDEMOUTH
AQ-392	FACEPLATE AND LID FOR DOUGHBOY (AQ-392 Actual Size: 11" x 7 1/2")
AQ-392L	LID ONLY FOR DOUGHBOY
AQ-393	FACEPLATE AND LID FOR LOMART (AQ-393 Actual Size: 10 1/4" x 10")
AQ-393L	LID ONLY FOR LOMART
AQ-394	FACEPLATE AND LID FOR 1084 (AQ-394 Actual Size: 10 3/4" x 8 5/8")
AQ-394L	LID ONLY FOR 1084
AQ-395	FACEPLATE AND LID FOR I/G 1085 (AQ-395 Actual Size: 18 1/4" x 8 5/8")
AQ-395L	LID ONLY FOR I/G 1085
AQ-397	FACEPLATE AND LID FOR AQUA GENIE I/G (AQ-397 Actual Size: 13 3/8" x 10 1/2")
AQ-397L	LID ONLY FOR AQUA GENIE I/G

BUG BUSTER SKIMMER ADD-ON

The Bug-Buster is designed to fit the Aquador 1090 above ground skimmer faceplate. This snap-on device triples the amount of debris that's drawn into your skimmer with its long, custom-designed tongue.

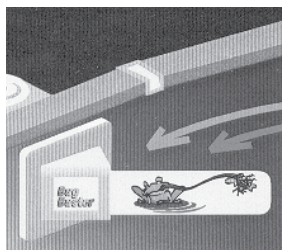

AQ-399
BUG-BUSTER

SKIMMER FACEPLATES TO FIT HAYWARD

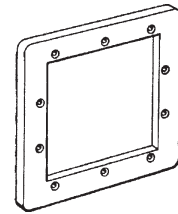

WHITE ABS PLASTIC

SF-450
SKIMMER FACEPLATE TO FIT HAYWARD
1090 SKIMMERS
Use Gasket # G-3006
8" x 8"
Replaces: SPX1090-D (K-2233)

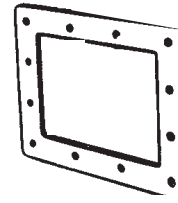

WHITE ABS PLASTIC

SF-451
SKIMMER FACEPLATE TO FIT HAYWARD
1084 SKIMMERS
Use Gasket #G-3020
10 1/2" x 8 1/4"
Replaces: SPX1084-L (K-2868)

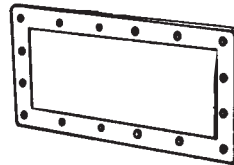

WHITE ABS PLASTIC

SF-452
SKIMMER FACEPLATE TO FIT HAYWARD
1085 WIDEMOUTH SKIMMERS
Use Gasket #G-3001
18 1/4" x 8 5/8"
Replaces: SPX1085-B

SKIMMER FACEPLATE COVERS



WHITE ABS PLASTIC

SF-451C
SKIMMER FACEPLATE COVER TO FIT HAYWARD
1084
8 3/4" x 11"
Replaces: SPX1084-F

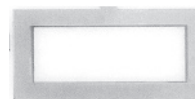

WHITE ABS PLASTIC

SF-452C
SKIMMER FACEPLATE COVER TO FIT HAYWARD
1085 WIDEMOUTH
8 7/8" x 18 1/2"
Replaces: SPX1085-F

Our Consolidated O-ring list on pgs. 39-51 will save you money. Check out these listings which show how one O-ring will fit many different applications. See how an O-ring for one OEM's filter will fit another's pump.



BASKETS / VACUUM PLATES / SKIM. PARTS

SKIMMER COVERS AND COLLAR

SQUARE



ABS PLASTIC

SC-491
SQUARE SKIMMER
COVER
10 1/16" x 10 1/16"
Replaces: SPX1082-E

ROUND

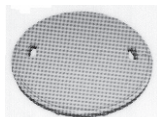

WHITE ABS PLASTIC

SC-492
ROUND SKIMMER COVER
TO FIT 1070
Replaces: SPX1070C

COLLAR TO FIT 1070

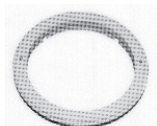

WHITE ABS PLASTIC

MF-458
WHITE 1070 SKIMMER
COVER ADJUSTING COLLAR
Replaces: SPX1070B

SOCKET GUTTER & REPLACEMENT GRATE

COMPLETE

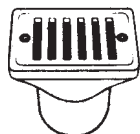

WHITE ABS PLASTIC

GC-495
GUTTER/DECK DRAIN
COMPLETE
2" FIP x 2" Socket
Replaces: SPX1019

GRATE ONLY



WHITE ABS PLASTIC

GC-490
SOCKET GUTTER
REPLACEMENT GRATE
Includes Screws
Replaces: SPX1019-BA

ANTI-HAIR SNARE DRAIN COVER

This drain cover offers an anti-hair entanglement design and a hi-low step design of the fingers on the drain cover which minimizes body entrapment and vacuum sealing (evisceration). The openings in this drain will also lessen the chance of toe and finger entrapment. The universal fastening design allows it to be retrofitted onto every known circular drain except the Sta Rite Swim Quip. This drain has a 2 year limited warranty.

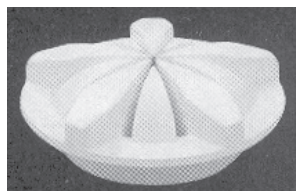

MF-458W
ANTI-HAIR SNARE MAIN
DRAIN COVER
Includes Screws
White Color

BASKETS TO FIT HAYWARD

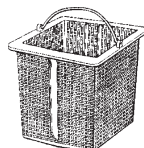

BA-693
BASKET TO FIT HAYWARD
SUPER PUMP
Replaces: SPX1600M



BA-692
BASKET TO FIT HAYWARD
POWER FLO-1992 & PRIOR
Replaces: SPX1250RA

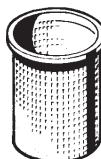

BA-694
BASKET TO FIT HAYWARD
POWER FLO LX
1992 TO PRESENT
Replaces: SPX1500LX



BA-690
BASKET TO FIT HAYWARD
1090 A/G SKIMMER
Replaces: SPX1096CA



BA-691
BASKET TO FIT HAYWARD
1084, 1085 I/G SKIMMER
Replaces: SPX1082CA

SKIMMER VACUUM PLATES TO FIT HAYWARD



VP-695
LARGE I/G SKIMMER
VACUUM PLATE
With Elbow Fitting
Replaces: SPX1107-1



VP-696
SMALL A/G SKIMMER
VACUUM PLATE
With Straight Fitting
Replaces: SPX1104-1











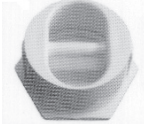

VP-697
VACUUM PLATE
STRAIGHT CONNECTOR

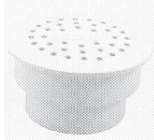

VP-698
VACUUM PLATE
ELBOW CONNECTOR

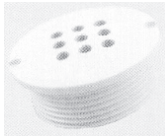
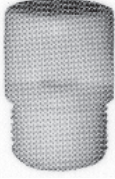
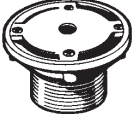
Please see pages 20-22 for our complete list of replacement parts to fit Hayward.

		PLASTIC GOODS, INSERT FITTINGS	
PLASTIC ROPE ANCHORS TO FIT HAYWARD		TEST PLUG FOR PRESSURE TESTING	
 <p>WITH STEEL PIN RA-574 ROPE ANCHOR WITH STEEL PIN TO FIT HAYWARD Replaces: SPX1040 White Plastic</p>	 <p>WP-22 TEST PLUG FOR PRESSURE TESTING Fits Hayward Replaces: SPX1434TP</p>		
 <p>WITH PLASTIC PIN RA-575 ROPE ANCHOR WITH PLASTIC PIN White Plastic</p>	EXTENSION COLLAR TO FIT HAYWARD		
	 <p>EC-573 EXTENSION COLLAR Replaces: SPX1084P1 Plastic</p>		
VOLLEYBALL POLE HOLDER	JET AIR FITTING KIT TO FIT HAYWARD		
 <p>VP-570 VOLLEYBALL POLE HOLDER Plastic</p>	 <p>JA-572 JET AIR FITTING KIT Replaces: SPX1433S Plastic</p>		
POOL CLEANER HOSE FLOAT	VENTED PLUG		
 <p>HF-571 POOL CLEANER HOSE FLOAT</p>	 <p>WP-23 VENTED PLASTIC PLUG WITH PERFORATED VENT 2" SP or 1 1/2" SP Fits 1 1/2" or 2" U-Bend</p>		
3-TIER POOL FOUNTAIN	POOL BUBBLER		
 <p>PF-576 3-TIER PLASTIC POOL FOUNTAIN Includes Fountainhead, Threaded Adapter and Eyeball Fitting</p>	 <p>RF-497 POOL BUBBLER Plastic 1 1/2" MIP</p>		
AERATORS	FLOOR INLET FITTING TO FIT HAYWARD		
<p>STANDARD</p>  <p>AE-578 STANDARD AERATOR Plastic-3/4"</p>	 <p>RF-484 FLOOR INLET FITTING- 1 1/2" SLIP X 2" MIP Replaces: SPX1425S</p>		
<p>ROUND</p>  <p>AE-579 ROUND AERATOR Plastic-3/4"</p>	GRATE INSERT FITTING TO FIT HAYWARD		
	 <p>RF-487 GRATE INSERT FITTING- FOR POOL WALL OUTLETS Replaces: SPX1026</p>		

M.D. RING / RETURN FTGS. / FLOW FTGS.

VINYL POOL MAIN DRAIN SEALING FRAME RING TO FIT HAYWARD



WHITE ABS PLASTIC

MF-457
VINYL POOL MAIN DRAIN SEALING FRAME RING
8" Diameter
Use Gasket #G-3170
Replaces: SPX1048B

RETURN FITTING FACEPLATES TO FIT HAYWARD

1408 FACEPLATE

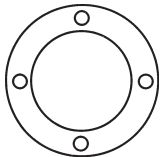

WHITE ABS PLASTIC

RF-455
RETURN FITTING FACEPLATE TO FIT HAYWARD 1408 FITTING
Use Gasket #G-4134
3 1/2" x 2"
Replaces: SPX1408B

1411 FACEPLATE - THREADED

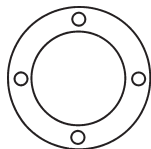

THREADED
WHITE ABS PLASTIC

RF-456
THREADED RETURN FITTING FACEPLATE TO FIT HAYWARD 1411 FITTING
Use Gasket # G-4124
3 1/2" x 2"
Replaces: SPX1411B

RETURN FITTINGS TO FIT HAYWARD

1408 FITTING FOR VINYL POOLS



WHITE ABS PLASTIC

RF-480
VINYL POOL I/O FITTING TO FIT HAYWARD
1 1/2" FIP x 1 1/2" FIP
Replaces: SPX1408

1023 FITTING FOR VINYL POOLS



WHITE ABS PLASTIC

RF-481
VINYL POOL I/O FITTING TO FIT HAYWARD
1 1/2" FIP
Replaces: SPX1023

1023 FITTING WITH EXTENDED LENGTH

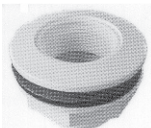

WHITE ABS PLASTIC

RF-483
VINYL POOL I/O FITTING-EXTENDED LENGTH-1 1/2" SKT
Replaces: SPX1023S

1022 FITTING FOR GUNITE POOLS



WHITE ABS PLASTIC

RF-482
GUNITE POOL I/O FITTING TO FIT HAYWARD
1 1/2" Socket x 2" MIP
Replaces: SPX1022

INSIDER FITTING FOR GUNITE POOLS

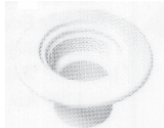

WHITE ABS PLASTIC

RF-489
INSIDER FITTING FOR CONCRETE POOLS
1 1/2" FIP Face x 1 1/2" Slip
Replaces: SPX1022INS

DIRECTIONAL FLOW OUTLET FITTINGS TO FIT HAYWARD

All of our directional flow fittings are made of white ABS plastic.

SLOTTED



DF-485A
SLOTTED SWEEP OPENING
Replaces: SPX1419A

3/8"



DF-485B
3/8" DIRECTIONAL STREAM
Replaces: SPX1419B

1/2"



DF-485C
1/2" DIRECTIONAL STREAM
Replaces: SPX1419C

3/4"



DF-485D
3/4" DIRECTIONAL STREAM
Replaces: SPX1419D

1"



DF-485E
1" DIRECTIONAL STREAM
Replaces: SPX1419E

3/4" WITH EXTENDED FLANGE



RF-486
DIRECTIONAL FLOW FITTING WITH EXTENDED FLANGE
3/4" Opening, 1 1/2" MIP
Replaces: SPX1418D

3/4" INSERT INLET FITTING



RF-488
INSERT INLET FITTING-
1 1/2" SLIP x 1" SKT
3/4" EYEBALL OPENING
Replaces: SPX2551-300

HOSE ADAPTER/HOSE CUFFS/COUPLINGS

EYEBALL SEAT REMOVAL TOOLS

These tools remove and install 1 1/2" grooved eyeballs (flow fittings) with very little difficulty. They make burdensome eyeball removal a snap.



STEEL

ST-369
EYEBALL SEAT
REMOVAL TOOL
Made of Forged Steel

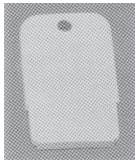

PLASTIC

ST-358
EYEBALL SEAT
REMOVAL TOOL
Made of Molded Plastic
Replaces Hayward
SPX1419T

NO RIPPED LINERS WHEN THE
PLASTIC ONE IS DROPPED!

HOSE ADAPTER

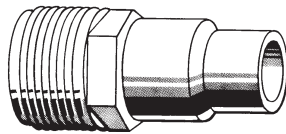

WHITE ABS PLASTIC

HA-460
HOSE ADAPTER
1 1/2" MIP x 1 1/4"
& 1 1/2" HOSE
Replaces: SP-1091-Z-7
(K-1759)

HOSE CUFFS

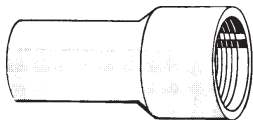

GRAY COLOR

HC-470
1 1/4" HOSE CUFF
Threaded

HC-471
1 1/2" HOSE CUFF
Threaded

HC-472
2" HOSE CUFF
Threaded

HOSE COUPLERS

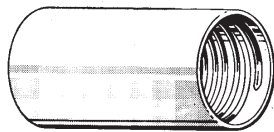

GRAY COLOR

HC-473
1 1/4" HOSE COUPLER
Threaded

HC-474
1 1/2" HOSE COUPLER
Threaded

HC-476
2" HOSE COUPLER
Threaded

9" LONG PLASTIC HOSE CONNECTOR

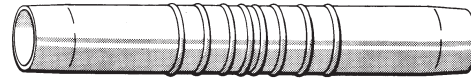

WHITE PLASTIC

HC-475
9" LONG PLASTIC
HOSE CONNECTOR
Fits inside 1 1/4" cuff.

FLEXIBLE PIPE (TRANSITION) COUPLINGS

Our pipe couplings will fit over plastic and cast iron pipe. They feature all stainless steel clamps and thick-walled neoprene sleeves for strength, durability and an easy installation.

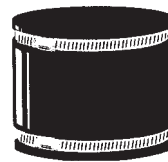

SSC#	PIPE SIZE
110254	1 1/2" x 1 1/2"
110258	2" x 2"
110264	3" x 3"
110270	4" x 3"
110272	4" x 4"

NO-HUB COUPLINGS

SSC's no-hub pipe couplings are used to join no hub cast iron soil pipe and fittings. A stainless steel corrugated shield and hose clamps are assembled over a molded neoprene sleeve to give you a strong, positive seal every time.

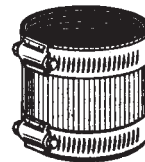

SSC#	PIPE SIZE
110300	1 1/2" x 1 1/2"
110302	2" x 1 1/2"
110304	2" x 2"
110306	3" x 3"
110310	4" x 4"

FLEXIBLE PIPE TEST (CLEAN-OUT) CAPS

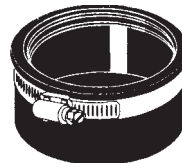

NEOPRENE RUBBER
STAINLESS CLAMP

SSC#	PIPE SIZE
110380	1 1/2"
110382	2"
110384	3"
110386	4"

TEST PLUGS (DOLLAR PLUGS)



GALVANIZED STEEL FLANGE
MOLDED RUBBER GASKET

SSC#	PIPE SIZE
110202	1 1/2"
110204	2"
110206	3"
110208	4"

HOSE CLAMPS

STAINLESS STEEL HOSE CLAMPS WITH PLATED STEEL SCREW

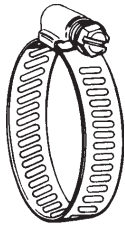

- 304 series stainless steel band
- 430 series stainless steel housing
- Plated steel screw
- 1/2" wide band
- Packed 10 clamps in a box
- Competitively priced

PACKED 10/BOX

SSC#	CLAMP#	SIZE
110506	6	3/8" to 7/8"
110508	8	7/16" to 1"
110510	10	9/16" to 1 1/16"
110512	12	11/16" to 1 1/4"
110516	16	13/16" to 1 1/2"
110520	20	13/16" to 1 3/4"
110524	24	11/16" to 2"
110528	28	1 5/16" to 2 1/4"
110532	32	1 9/16" to 2 1/2"
110536	36	1 13/16" to 2 3/4"
110540	40	2 1/16" to 3"
110544	44	2 5/16" to 3 1/4"
110548	48	2 9/16" to 3 1/2"
110552	52	2 13/16" to 3 3/4"
110556	56	3 1/16" to 4"
110560	60	3 5/16" to 4 1/4"
110564	64	3 9/16" to 4 1/2"
110572	72	4 1/8" to 5"

STAINLESS STEEL HOSE CLAMPS WITH STAINLESS STEEL SCREW

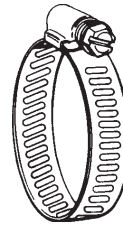

- 304 series stainless steel band
- 304 series stainless steel housing
- 302 series stainless steel screw
- UPC approved
- Commonly known as "Marine Grade"
- 1/2" wide band
- Packed 10 clamps in a box
- Competitively priced

PACKED 10/BOX

SSC#	CLAMP#	SIZE
110406	6	3/8" to 7/8"
110408	8	7/16" to 1"
110410	10	9/16" to 1 1/16"
110412	12	11/16" to 1 1/4"
110416	16	13/16" to 1 1/2"
110420	20	13/16" to 1 3/4"
110424	24	11/16" to 2"
110428	28	1 5/16" to 2 1/4"
110432	32	1 9/16" to 2 1/2"
110436	36	1 13/16" to 2 3/4"
110440	40	2 1/16" to 3"
110444	44	2 5/16" to 3 1/4"
110448	48	2 9/16" to 3 1/2"
110452	52	2 13/16" to 3 3/4"
110456	56	3 1/16" to 4"
110460	60	3 5/16" to 4 1/4"
110464	64	3 9/16" to 4 1/2"
110472	72	4 1/8" to 5"

MINI HOSE CLAMPS WITH PLATED STEEL SCREW



- 304 series stainless steel band
- 430 series stainless steel housing
- Plated steel screw
- 5/16" wide band
- Packed 10 clamps in a box

PACKED 10/BOX

SSC#	CLAMP#	SIZE
110501	4 Mini	7/32" to 5/8"
110502	6 Mini	7/16" to 25/32"

MINI HOSE CLAMPS WITH STAINLESS STEEL SCREW



- 304 stainless steel band & housing
- 302 stainless steel screw
- UPC approved
- 5/16" wide band
- Packed 10 clamps in a box

PACKED 10/BOX

SSC#	CLAMP#	SIZE
110401	4 Mini	7/32" to 5/8"
110402	6 Mini	7/16" to 25/32"

Use SSC's Website to Find Your Replacement Parts and Order Online!

- Place orders online using our shopping cart feature.
- Find your part using our multi-functional "Part Search" engine.
- Registration is required. This ensures that only Pool & Spa Dealers and Service Companies, not the general public, can see pricing and use the shopping cart.

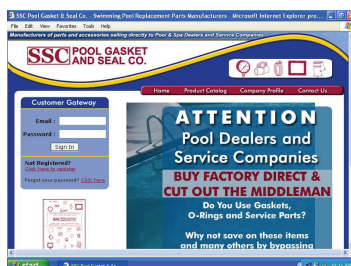

www.poolgasket.com

TORQUE WRENCH FOR HOSE CLAMPS

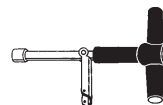

111062
TORQUE WRENCH
Tightens to 60 ft. lbs.

HINGED PIPE REPAIR CLAMPS

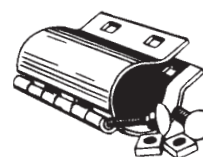

SSC#	PIPE SIZE
110350	1/2"
110352	3/4"
110354	1"
110356	1 1/4"
110358	1 1/2"
110360	2"

PVC EXTENSIONS, UNIONS, FITTINGS

PVC SCHEDULE 40 FITTINGS

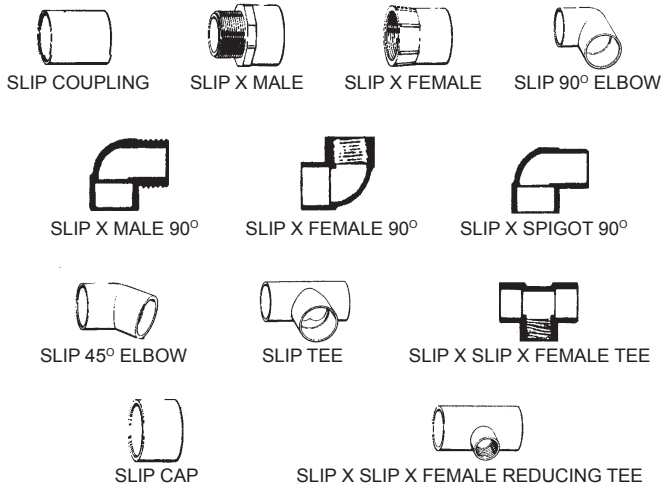

DESCRIPTION	1 1/2" (SSC#)	2" (SSC#)
Slip Coupling	133110	134220
Slip X Male Adapter	133120	134230
Slip X Female Adapter	133130	134240
Slip 90° Elbow	133140	134250
Slip X Male 90° Elbow	133150	134260
Slip X Female 90° Elbow	133160	134270
Slip X Spigot 90° Elbow	133170	134280
Slip 45° Elbow	133180	134290
Slip Tee	133190	134300
Slip X Slip X Female Tee	133200	134310
Slip Cap	133210	134320

1 1/2" Slip X 1 1/2" Slip X 3/4" Female Reducing Tee: #135100

PIPE EXTENSIONS

STANDARD



133220
REGULAR PIPE EXTENSION
1 1/2"

134330
REGULAR PIPE EXTENSION
2"

RIBBED



133230
RIBBED PIPE EXTENSION
1 1/2"

134340
RIBBED PIPE EXTENSION
2"

PVC SCHEDULE 40 UNIONS

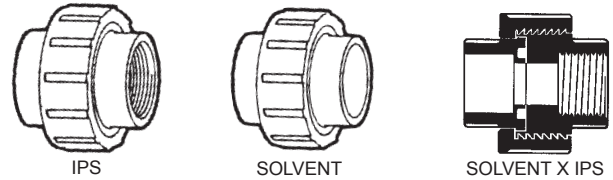

SSC#	SIZE
120230	1 1/2" IPS-FEMALE THREAD
120232	2" IPS-FEMALE THREAD
120250	1 1/2" SOLVENT
120252	2" SOLVENT
120260	1 1/2" SOLVENT X IPS-FEM. THD
120262	2" SOLVENT X IPS-FEM THD

UNIONS TO FIT HAYWARD

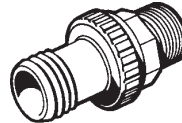

U-560
ECONO UNION
1 1/2" BARB X 1 1/2" MIP
Replaces: SPX1493

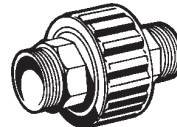

U-561
PVC UNION
1 1/2" MIP x 1 1/2" MIP
Replaces: SPX1480



U-562
SELF ALIGNING DOUBLE
MALE END UNION WITH
90° END SWEEP
Replaces: SPX1485

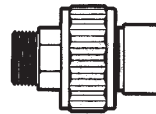

U-563
MALE UNION
1 1/2" MIP X 1 1/2" SOCKET
Replaces: SPX1484



U-564
FLUSH UNION
1 1/2" MIP X 1 1/2" SOCKET
Replaces: SPX14953S



U-565
FLUSH UNION
1 1/2" MIP X 1 1/2" SLIP
Replaces: SPX1482

If we are missing any pipe or plumbing parts that you need let us know and we'll try to get them.

BALL VALVES

SINGLE UNION PVC BALL VALVES

SSC's Single Union Ball Valves are lightweight and compact and designed for Pool & Spa installations. The full port ball gives minimum pressure drop and the valves are rated at 225 psi test pressure and 150 psi working pressure.

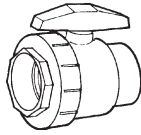

SOCKET / IPS (FIP) END

SSC#	SIZE
120270	1 1/2" SOLVENT END
120272	2" SOLVENT END
120280	1 1/2" IPS (FIP)
120282	2" IPS (FIP)

1 1/2" PVC SINGLE UNION BALL VALVE WITH NIPPLE END TO FIT HAYWARD

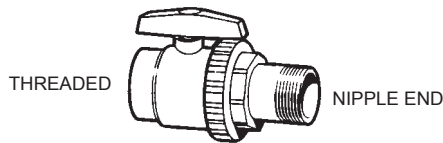

THREADED

NIPPLE END

120292
1 1/2" THREADED MIP PVC
SINGLE UNION BALL
VALVE WITH NIPPLE END
Replaces: SPX723

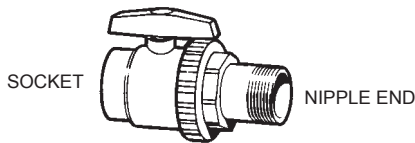

SOCKET

NIPPLE END

120290
1 1/2" SOCKET PVC
SINGLE UNION BALL
VALVE WITH NIPPLE END
Replaces: SPX723S

BUMP SHAFT RETAINER C-CLIP



STAINLESS

E-6600
BUMP SHAFT RETAINER
C-CLIP TO FIT HAYWARD
PERFLEX DE FILTERS
Replaces: ECX1014
Stainless Steel

PVC BALL VALVES

IPS

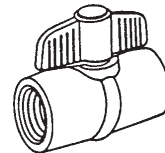

1 PIECE CONSTRUCTION
1/4 TURN OPERATION

SSC#	SIZE
122324	1/2"
122326	3/4"
122328	1"
122330	1 1/4"
122332	1 1/2"
122334	2"

SOLVENT WELD

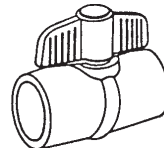

1 PIECE CONSTRUCTION
1/4 TURN OPERATION

SSC#	SIZE
122354	1/2"
122356	3/4"
122358	1"
122360	1 1/4"
122362	1 1/2"
122364	2"

FULL PORT FORGED BRASS BALL VALVES - 600 WOG

IPS

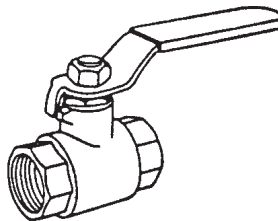

- Full Port
- 600 WOG / 150 WSP
- Forged Brass
- Yellow Vinyl Covered Handle

SSC#	SIZE
122130	1/4"
122132	3/8"
122134	1/2"
122136	3/4"
122138	1"
122140	1 1/4"
122142	1 1/2"
122144	2"

C x C

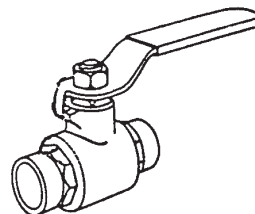

- Full Port
- 600 WOG / 150 WSP
- Forged Brass
- Yellow Vinyl Covered Handle

SSC#	SIZE
122104	1/2"
122106	3/4"
122108	1"
122110	1 1/4"
122112	1 1/2"
122114	2"

CHECK VALVES/COMPRESSION COUPLINGS

BRASS SWING CHECK VALVES

Our brass swing check valves have a hinged flap and can be used in water or oil applications.

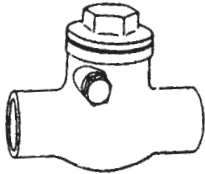

IPS



C x C

SSC#	SIZE
121004	1/2" CxC
121006	3/4" CxC
121008	1" CxC
121010	1 1/4" CxC
121012	1 1/2" CxC
121014	2" CxC
121032	1/2" IPS
121034	3/4" IPS
121036	1" IPS
121038	1 1/4" IPS
121040	1 1/2" IPS
121042	2" IPS

PVC CHECK VALVES - SPRING LOADED

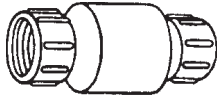

IPS

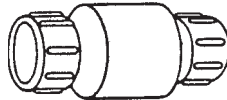

SOLVENT WELD

SSC#	SIZE
121132	1 1/2" IPS
121150	1 1/2" SOLVENT
121152	2" SOLVENT

SEWAGE EJECTOR CHECK VALVE

COMBINATION SIZE - FITS 1 1/4" & 1 1/2" IPS

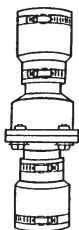

121170
SEWAGE EJECTOR
CHECK VALVE
Plastic Valve Body with
Rubber Ends & Hose Clamps
Combination Size: 1 1/4" &
1 1/2" IPS

PVC COMPRESSION COUPLINGS - LONG PATTERN

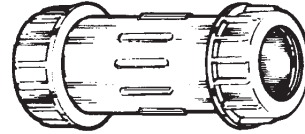

SSC#	DESCRIPTION	PIPE SIZE
121222	LONG PATTERN	1/2"
121224	LONG PATTERN	3/4"
121226	LONG PATTERN	1"
121228	LONG PATTERN	1 1/4"
121230	LONG PATTERN	1 1/2"
121232	LONG PATTERN	2"

GALVANIZED COMPRESSION COUPLINGS - LONG PATTERN



SSC#	DESCRIPTION	PIPE SIZE
121253	LONG PATTERN	1/2"
121255	LONG PATTERN	3/4"
121257	LONG PATTERN	1"
121259	LONG PATTERN	1 1/4"
121261	LONG PATTERN	1 1/2"
121263	LONG PATTERN	2"

BOILER DRAINS

MALE IRON PIPE

122408
BOILER DRAIN WITH
STUFFING BOX
3/4" Hose End
Brass
1/2" MIP

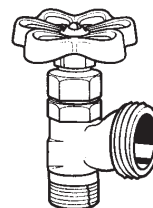

122410
BOILER DRAIN WITH
STUFFING BOX
3/4" Hose End
Brass
3/4" MIP

FEMALE IRON PIPE

122404
BOILER DRAIN WITH
STUFFING BOX
3/4" Hose End
Brass
1/2" FIP

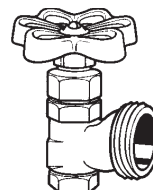

SSC's Pump Repair and Service Kits (Go-Kits) make it quick and easy to service pumps. We eliminate the guesswork sometimes needed when getting the right parts together for pump repair or service. All are skin-packed for display and bar-coded. See pgs. 73-75.



SILCOCKS / FROST FREE / KEY

STOP AND WASTE VALVES

C x C

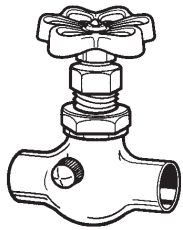

122606
STOP AND WASTE VALVE
With Bleeder Cap
Brass
1/2"

122608
STOP AND WASTE VALVE
With Bleeder Cap
Brass
3/4"

STOP AND WASTE CAP



122620
STOP AND WASTE CAP
5/16" x 24T
Includes Washer
Brass

HOSE BIBBS

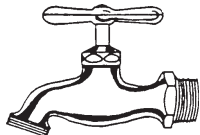

CHROME PLATED BRASS

SSC#	TYPE	SIZE
160010	3/4" HOSE END	1/2" MIP
160020	3/4" HOSE END	3/4" MIP
160030	PLAIN END	1/2" MIP
160035	PLAIN END	3/4" MIP

4-WAY SILCOCK KEY

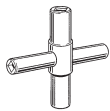

111020
4-WAY SILCOCK KEY
Fits 1/4", 9/32", 5/16", 11/32"

SELF-TAPPING SADDLE VALVE



INDIVIDUALLY BAGGED

122600
SELF-PIERCING
SADDLE VALVE
Connects 1/4" bleed
lines to copper tubing
from 3/8" to 1 3/8"

ANGLE SILCOCKS

FEMALE IRON PIPE

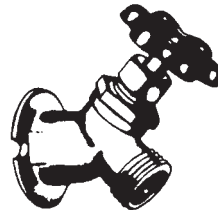

122544
ANGLE SILCOCK
3/4" Hose Outlet
Brass
1/2" FIP

122546
ANGLE SILCOCK
3/4" Hose Outlet
Brass
3/4" FIP

C x C

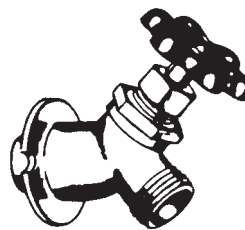

122540
ANGLE SILCOCK
3/4" Hose Outlet
Brass
1/2" C x C

122542
ANGLE SILCOCK
3/4" Hose Outlet
Brass
3/4" C x C

FROST FREE SILCOCKS

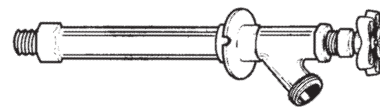

CHROME PLATED BRASS

SSC#	DESCRIPTION	LENGTH
122505	1/2" MIP x 1/2" CxC	6"
122507	1/2" MIP x 1/2" CxC	8"
122509	1/2" MIP x 1/2" CxC	10"
122511	1/2" MIP x 1/2" CxC	12"

ANTI-SYPHON FROST FREE SILCOCKS

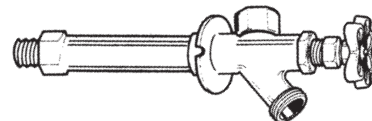

CHROME PLATED BRASS

SSC#	DESCRIPTION	LENGTH
122525	1/2" MIP x 1/2" CxC	6"
122527	1/2" MIP x 1/2" CxC	8"
122529	1/2" MIP x 1/2" CxC	10"
122531	1/2" MIP x 1/2" CxC	12"

If we are missing the plumbing or pipe part that you need, let us know and we'll try to add it to our line.

HOSE CAPS AND GASKETS

BRASS HOSE CAP WITH GASKET INCLUDED

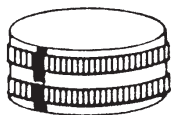

INCLUDES GASKET

HC-305
 BRASS HOSE CAP
 FOR 3/4" THREAD
 For capping boiler drains,
 valves, hoses etc.
 Made of knurled brass
 Includes G-194 gasket

PLASTIC HOSE CAP WITH GASKET INCLUDED

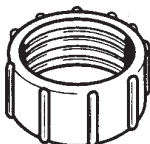

INCLUDES GASKET

HC-306
 PLASTIC HOSE CAP
 FOR 3/4" THREAD
 Same as above except
 made of plastic
 Includes G-194 gasket

HOSE CAP WASHERS



ACTUAL SIZE: 1 1/16" OD
 X 9/16" ID

G-194
 HOSE CAP WASHER
 Neoprene (Black Rubber)

G-194RR
 HOSE CAP WASHER
 Red Rubber

MISCELLANEOUS HOSE PARTS

HOSE INLET FILTER SCREEN



122569
 Prevents Sediment
 3/4"

SIAMESE HOSE CONNECTION



122568
 With Dual Shut-Off
 3/4"

REPAIR COUPLING - MALE END



122565
 Plastic
 3/4"

REPAIR COUPLING - FEMALE END



122566
 Plastic
 3/4"

HOSE MENDER



122567
 Connects 2 Hose Pieces
 Plastic
 3/4"

HOSE BACKFLOW PREVENTER



122570
 HOSE BACKFLOW
 PREVENTER (Vacuum
 Breaker)
 Rough Brass
 3/4" Female Hose X 3/4" M
 With Break-off Set Screw

BRASS HOSE FITTINGS

FEMALE HOSE TO FEMALE PIPE



122573
 3/4" FH X 3/4" FIP

MALE HOSE TO FEMALE PIPE



122576
 3/4" MH X 3/4" FIP

MALE HOSE TO MALE HOSE



122579
 3/4" MH X 3/4" MH

FEMALE HOSE TO MALE PIPE



122581
 3/4" FH X 3/4" MIP
 (1/2" FIP TAPPED)

MALE HOSE TO MALE PIPE



122584
 3/4" MH X 3/4" MIP
 (1/2" FIP TAPPED)

FEMALE HOSE TO FEMALE HOSE SWIVEL



122587
 3/4" FH X 3/4" FH

FEMALE HOSE TO FEMALE PIPE SWIVEL

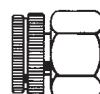

122590
 3/4" FH X 3/4" 3/4" FIP

PACKING / PIPE FLANGE GASKETS

AIR BLEEDER VALVES / DRAIN COCKS

Some common uses are to release air from Pool & Spa filters and water from pool heaters.

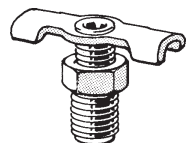

BRASS

SSC#	SIZE
122070	1/8"
122072	1/4"
122074	3/8"

SOLID BRASS PLUGS

Use SSC's solid brass plugs for plugging air-relief valves, drain openings etc. Similar to our drain cocks except solid.

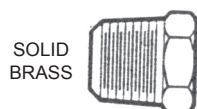

SOLID BRASS

SSC#	SIZE
122080	1/8"
122082	1/4"
122084	3/8"

MECHANICAL PACKING - GRAPHITE, TEFLON AND NON-STAINING GRAPHITE

SSC's packing can be used to seal shafts, valve plugs and other general service applications.



PACKED IN 1 LB. SPOOLS & INDIVIDUALLY BOXED

SSC#	TYPE	SIZE	FT/LB	TEMP.
PAC-29A	N/S GRAPHITE	1/8"	101	550°
PAC-29B	N/S GRAPHITE	3/16"	60	550°
PAC-29C	N/S GRAPHITE	1/4"	25	550°
PAC-29D	N/S GRAPHITE	5/16"	14.1	550°
PAC-29E	N/S GRAPHITE	3/8"	10	550°
PAC-29F	N/S GRAPHITE	1/2"	5.7	550°
PAC-30A	GRAPHITE	1/8"	101	550°
PAC-30B	GRAPHITE	3/16"	60	550°
PAC-30C	GRAPHITE	1/4"	25	550°
PAC-30D	GRAPHITE	5/16"	14.1	550°
PAC-30E	GRAPHITE	3/8"	10	550°
PAC-30F	GRAPHITE	1/2"	5.7	550°
PAC-31A	TEFLON	1/8"	75.5	500°
PAC-31B	TEFLON	3/16"	34.3	500°
PAC-31C	TEFLON	1/4"	20.9	500°
PAC-31D	TEFLON	5/16"	13.4	500°
PAC-31E	TEFLON	3/8"	8.7	500°
PAC-31F	TEFLON	1/2"	6	500°

PIPE FLANGE GASKETS

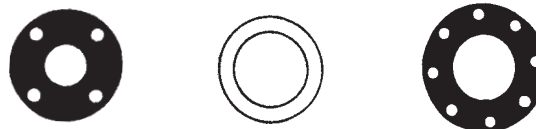

For 150 lb. flanges and fittings. Old standard or new ANSI. Inside measurements are used.

MATERIAL: 1/8" THICK RED RUBBER

SIZE	RING GASKET	FULL FACE GASKET
1/2	PF-50RR8	PF-50RF8
3/4	PF-75RR8	PF-75RF8
1	PF-100RR8	PF-100RF8
1 1/4	PF-125RR8	PF-125RF8
1 1/2	PF-150RR8	PF-150RF8
2	PF-200RR8	PF-200RF8
2 1/2	PF-250RR8	PF-250RF8
3	PF-300RR8	PF-300RF8
3 1/2	PF-350RR8	PF-350RF8
4	PF-400RR8	PF-400RF8
4 1/2	PF-450RR8	PF-450RF8
5	PF-500RR8	PF-500RF8
6	PF-600RR8	PF-600RF8
7	PF-700RR8	PF-700RF8
8	PF-800RR8	PF-800RF8
10	PF-1000RR8	PF-1000RF8
12	PF-1200RR8	PF-1200RF8

MATERIAL: 1/16" THICK RED RUBBER

SIZE	RING GASKET	FULL FACE GASKET
1/2	PF-50RR16	PF-50RF16
3/4	PF-75RR16	PF-75RF16
1	PF-100RR16	PF-100RF16
1 1/4	PF-125RR16	PF-125RF16
1 1/2	PF-150RR16	PF-150RF16
2	PF-200RR16	PF-200RF16
2 1/2	PF-250RR16	PF-250RF16
3	PF-300RR16	PF-300RF16
3 1/2	PF-350RR15	PF-350RF16
4	PF-400RR16	PF-400RF16
4 1/2	PF-450RR16	PF-450RF16
5	PF-500RR16	PF-500RF16
6	PF-600RR16	PF-600RF16
7	PF-700RR16	PF-700RF16
8	PF-800RR16	PF-800RF16
10	PF-1000RR16	PF-1000RF16
12	PF-1200RR16	PF-1200RF16

Our Consolidated O-ring list on pgs. 39-51 will save you money. Check out these listings which show how one O-ring will fit many different applications. See how an O-ring for one OEM's filter will fit another's pump.



PIPE FLANGE GASKETS

MATERIAL: 1/8" THICK NEOPRENE (BLACK) RUBBER

SIZE	RING GASKET	FULL FACE GASKET
1/2	PF-50NR8	PF-50NF8
3/4	PF-75NR8	PF-75NF8
1	PF-100NR8	PF-100NF8
1 1/4	PF-125NR8	PF-125NF8
1 1/2	PF-150NR8	PF-150NF8
2	PF-200NR8	PF-200NF8
2 1/2	PF-250NR8	PF-250NF8
3	PF-300NR8	PF-300NF8
3 1/2	PF-350NR8	PF-350NF8
4	PF-400NR8	PF-400NF8
4 1/2	PF-450NR8	PF-450NF8
5	PF-500NR8	PF-500NF8
6	PF-600NR8	PF-600NF8
7	PF-700NR8	PF-700NF8
8	PF-800NR8	PF-800NF8
10	PF-1000NR8	PF-1000NF8
12	PF-1200NR8	PF-1200NF8

MATERIAL: 1/16" THICK NEOPRENE (BLACK) RUBBER

SIZE	RING GASKET	FULL FACE GASKET
1/2	PF-50NR16	PF-50NF16
3/4	PF-75NR16	PF-75NF16
1	PF-100NR16	PF-100NF16
1 1/4	PF-125NR16	PF-125NF16
1 1/2	PF-150NR16	PF-150NF16
2	PF-200NR16	PF-200NF16
2 1/2	PF-250NR16	PF-250NF16
3	PF-300NR16	PF-300NF16
3 1/2	PF-350NR16	PF-350NF16
4	PF-400NR16	PF-400NF16
4 1/2	PF-450NR16	PF-450NF16
5	PF-500NR16	PF-500NF16
6	PF-600NR16	PF-600NF16
7	PF-700NR16	PF-700NF16
8	PF-800NR16	PF-800NF16
10	PF-1000NR16	PF-1000NF16
12	PF-1200NR16	PF-1200NF16

MATERIAL: 1/16" THICK NON-ASBESTOS

SIZE	RING GASKET	FULL FACE GASKET
1/2	PF-50AR16	PF-50AF16
3/4	PF-75AR16	PF-75AF16
1	PF-100AR16	PF-100AF16
1 1/4	PF-125AR16	PF-125AF16
1 1/2	PF-150AR16	PF-150AF16
2	PF-200AR16	PF-200AF16
2 1/2	PF-250AR16	PF-250AF16
3	PF-300AR16	PF-300AF16
3 1/2	PF-350AR16	PF-350AF16
4	PF-400AR16	PF-400AF16
4 1/2	PF-450AR16	PF-450AF16
5	PF-500AR16	PF-500AF16
6	PF-600AR16	PF-600AF16
7	PF-700AR16	PF-700AF16
8	PF-800AR16	PF-800AF16
10	PF-1000AR16	PF-1000AF16
12	PF-1200AR16	PF-1200AF16

MATERIAL: 1/8" THICK NON-ASBESTOS

SIZE	RING GASKET
1/2	PF-50AR8
3/4	PF-75AR8
1	PF-100AR8
1 1/4	PF-125AR8
1 1/2	PF-150AR8
2	PF-200AR8
2 1/2	PF-250AR8
3	PF-300AR8

BOLT PACKS



SSC's Bolt Packs include any of the above listed Pipe Flange Gaskets individually packed with the appropriate ASTM-A307 Grade 2 hex head bolts with finished hex nuts. These kits offer the convenience of having all flange parts in one package. To order a kit just add the letters "BP" to the end of the gasket number listed above. For example to order a 4" full faced flange gasket (1/8" Red Rubber) bolt pack, use part #PF-400RF9BP.

PIPE FLANGE BOLTS AND NUTS

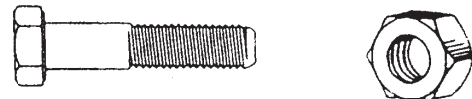

SSC#	DESCRIPTION
PF-100B	BOLT FOR 1/2", 3/4", 1", 1 1/4", 1 1/2" PIPE FLGS.
PF-100N	NUT FOR 1/2", 3/4", 1", 1 1/4", 1 1/2" PIPE FLGS.
PF-200B	BOLT FOR 2", 2 1/2", 3", 3 1/2", 4", 4 1/2" PIPE FLG
PF-200N	NUT FOR 2", 2 1/2", 3", 3 1/2", 4", 4 1/2" PIPE FLGS.
PF-500B	BOLT FOR 5", 6", 7", 8" PIPE FLANGES
PF-500N	NUT FOR 5", 6", 7", 8" PIPE FLANGES
PF-1000B	BOLT FOR 10", 12" PIPE FLANGES
PF-1000N	NUT FOR 10", 12" PIPE FLANGES

CROSS REFERENCE-SCP TO SSC

SCP#	SSC#	SCP#	SSC#	SCP#	SSC#	SCP#	SSC#	SCP#	SSC#	SCP#	SSC#	SCP#	SSC#
AMP-051-1050	G-4371	BAK-051-1489	G-5058	HAY-101-1464	O-2104	JDY-561-2294	O-2220	PUR-051-4906	O-1073	STA-101-7529	G-3151		
AMP-051-1064	O-1143	BAK-051-1490	G-5011	HAY-101-1959	BA-692	JDY-561-2411	O-2049	PUR-051-4907	O-1029	STA-101-7530	G-3197		
AMP-051-1068	O-1141	BAK-051-1545	O-2082	HAY-101-1962	G-5039	LAR-151-1524	G-5066	PUR-051-7290	G-3175	STA-101-7802	G-3240		
AMP-051-1073	O-2106	BAK-051-5102	K-6006	HAY-101-1995	O-2040	LAR-151-2515	G-4463	PUR-061-3401	O-2165	STA-101-8510	O-1163		
AMP-051-1074	O-2378	BAK-051-6742	O-2188	HAY-101-2001	MS-2131	LAR-151-2539	O-2223	PUR-061-3402	O-2209	STA-101-8518	G-3411		
AMP-051-1085	O-2106	BAK-051-7514	O-2040	HAY-101-2004	O-2007	LAR-151-2615	G-5063	PUR-061-3403	O-2220	STA-101-8523	O-2167		
AMP-051-1086	G-4278	BAK-061-6355	G-4268	HAY-101-2006	O-2152	LAR-151-2623	G-5151	PUR-061-3406	O-2124	STA-101-8533	O-1032		
AMP-051-1087	G-4237	BOL-451-5126	O-2228	HAY-101-2013	BA-693	LAR-151-2632	G-4612	PUR-061-3406	O-2124	STA-101-8539	G-4620		
AMP-051-1088	O-2224	BOL-451-5135	G-4617	HAY-101-2016	O-2618	LAR-151-7536	G-4037	PUR-101-3369	G-4123	STA-101-8546	O-2142		
AMP-051-1089	G-4647	BOL-451-5168	O-2524	HAY-101-2018	O-1209	LET-201-1020	O-2369	PUR-101-3400	O-2041	STA-101-8557	O-2002		
AMP-051-1090	O-2120	COM-561-1918	O-2220	HAY-101-2020	MS-201	LET-201-1023	O-2124	PUR-101-3404	O-1067	STA-251-2824	G-3401		
AMP-051-1121	O-1039	EZC-451-113	G-4610	HAY-101-2041	O-2143	LET-201-2021	G-4391	PUR-101-3430	MS-201	STA-251-8761	G-3032		
AMP-051-1142	O-1042	EZC-451-114	O-2082	HAY-101-2066	O-2247	LET-201-2083	O-2242	PUR-101-4890	MS-360	STA-301-532	G-4614		
AMP-051-1154	G-4290	FST-30-6642	O-2112	HAY-101-2067	O-1217	OLY-251-2103	G-3006K	PUR-101-4891	O-2249	STA-601-5141	MS-1000		
AMP-051-1154	O-2239	FST-30-6643	G-4622	HAY-101-2081	O-2209	PAC-051-102	G-4295	PUR-101-6166	G-4633	SWQ-051-3899	O-1133		
AMP-051-1165	O-2106	HAR-051-1705	O-2188	HAY-101-5095	G-3125	PAC-051-1474	O-2220	PUR-101-6168	MS-1000	SWQ-051-3900	O-1015		
AMP-051-1217	G-4458	HAR-051-1706	O-1207	HAY-101-5095	G-4119	PAC-051-1478	O-2115	PUR-101-6172	O-2216	SWQ-051-3901	O-1002		
AMP-051-1217	G-4611	HAR-051-1707	G-4402	HAY-101-7223	O-2518	PAC-051-1899	O-2041	PUR-101-6173	O-2103	SWQ-051-3912	O-1106		
AMP-051-1231	O-2054	HAR-051-1710	G-4334	HAY-101-8007	O-2286	PAC-051-2829	O-2282	PUR-101-9943	O-2208	SWQ-051-3915	O-1009		
AMP-051-1235	O-2040	HAR-051-1722	O-2165	HAY-101-8008	O-2100	PAC-051-2835	G-4324	PUR-151-4883	G-4329	SWQ-051-3918	O-1046		
AMP-051-1246	O-2375	HAR-051-1723	O-2189	HAY-101-8010	O-2128	PAC-051-2844	O-2141	PUR-151-4975	G-4455	SWQ-051-3953	O-2082		
AMP-051-7976	O-1142	HAR-051-1725	G-4404	HAY-101-8011	MS-200	PAC-051-2871	103015PL	PUR-561-2789	O-2030	SWQ-051-3958	O-2134		
AMP-051-8018	O-2090	HAR-051-1727	G-4403	HAY-101-9848	O-2252	PAC-051-2876	O-2189	PUR-561-2790	O-2044	SWQ-051-3961	O-2004		
AMP-061-1066	O-2410	HAR-061-7711	O-2002	HAY-251-1531	HA-460	PAC-051-2884	O-1048	PUR-561-9409	O-2040	SWQ-051-3964	O-2403		
AMP-061-1068	O-2133	HAR-061-9334	O-2200	HAY-251-1879	G-4243	PAC-051-2921	O-2082	RAI-051-3476	O-2135	SWQ-051-4728	O-2100		
AMP-061-1071	G-5105	HAY-031-2086	G-5126	HAY-251-1883	MF-457	PAC-051-2935	O-2215	RAI-051-3477	G-4337	SWQ-061-3812	G-5012		
AMP-061-1071	G-4300	HAY-051-1378	K-6020	HAY-251-1885	G-3170	PAC-051-2936	O-2106	RAI-051-3478	O-2095	SWQ-061-3827	G-4619		
AMP-061-1073	O-2024	HAY-051-1413	O-1144	HAY-251-1885	G-4116	PAC-051-2964	O-1037	RAI-051-3499	O-2082	SWQ-061-3955	O-2239		
AMP-061-1075	O-2068	HAY-051-1463	O-2306	HAY-251-1894	SC-492	PAC-051-2996	O-2374	RAI-401-6204	O-2041	SWQ-061-3956	O-2280		
AMP-061-1092	O-2297	HAY-051-1465	O-2239	HAY-251-1911	BA-691	PAC-051-3053	O-1070	RAI-451-4013	O-2522	SWQ-061-3959	O-2010		
AMP-061-1122	O-2175	HAY-051-1469	O-2124	HAY-251-1923	G-3020	PAC-051-6979	G-4296	RAI-451-4020	G-4327	SWQ-061-3963	O-2297		
AMP-061-6338	O-2126	HAY-051-1748	O-2095	HAY-251-1923	G-4065	PAC-051-6981	O-2100	RAI-451-4212	O-2112	SWQ-101-3843	O-2095		
AMP-061-8950	O-2115	HAY-051-1757	O-1215	HAY-251-1924	G-3014	PAC-051-8099	O-2292	RAI-451-4216	G-4393	SWQ-101-3962	O-2025		
AMP-101-1012	O-1082	HAY-051-1766	O-2116	HAY-251-1927	SF-451	PAC-061-3002	O-2124	RAY-151-1294	K-6021	SWQ-251-3957	O-2041		
AMP-101-1014	O-2111	HAY-051-1780	O-1054	HAY-251-1932	SCR-410	PAC-061-3024	O-2040	RAY-151-3615	G-4314	SWQ-301-3786	G-5124		
AMP-101-1020	O-2095	HAY-051-1798	O-1001	HAY-251-1934	SF-452	PAC-061-3049	O-2068	RAY-151-3616	G-4420	SWQ-301-5850	G-4148		
AMP-101-1031	O-2060	HAY-051-1802	O-2106	HAY-251-1935	G-3001	PAC-061-3050	O-2008	RAY-151-3710	O-2393				
AMP-101-1034	G-4284	HAY-051-1818	G-5153	HAY-251-1935	G-4064	PAC-061-7497	G-5106	RAY-151-4099	G-5036				
AMP-101-1039	G-4409	HAY-051-1825	E-6600	HAY-251-1937	SCR-420	PAC-061-7499	O-2025	RAY-151-9046	G-4357				
AMP-101-1043	O-2082	HAY-051-1837	G-5152	HAY-251-1947	G-4041	PAC-061-7716	G-4362	STA-051-2511	O-1162				
AMP-101-1096	O-2054	HAY-051-1849	O-2105	HAY-251-1947	G-3002	PAC-061-8966	O-2261	STA-051-2589	O-1157				
AMP-101-1112	O-2066	HAY-051-1858	103015PL	HAY-251-1967	RF-455	PAC-061-8967	O-2266	STA-051-2701	O-2002				
AMP-101-2775	O-2079	HAY-051-1859	103009PL	HAY-251-1968	G-4134	PAC-061-8979	O-2302	STA-051-2703	O-2114				
AMP-101-4011	O-2218	HAY-051-1859	103009PL	HAY-251-1969	RF-456	PAC-061-9576	G-5120	STA-051-2705	O-2092				
AMP-251-1261	G-3034	HAY-051-1864	O-2135	HAY-251-1971	G-4124	PAC-061-9577	O-2091	STA-051-2721	O-2046				
AMP-251-1261	G-4008	HAY-051-1867	O-2058	HAY-251-1973	DF-485A	PAC-101-3059	O-2080	STA-051-2809	O-1164				
AMP-251-1281	O-2224	HAY-051-1922	O-2090	HAY-251-1974	DF-485B	PAC-101-3059	O-2172	STA-051-2947	O-2040				
AMP-251-1339	O-2239	HAY-051-1994	G-5033	HAY-251-1975	DF-485C	PAC-101-3060	O-2408	STA-051-2948	O-2231				
AMP-251-5052	G-3011	HAY-051-1998	O-2355	HAY-251-1976	DF-485D	PAC-101-3060	O-2028	STA-051-3747	O-2047				
AMP-251-5053	G-3009	HAY-051-2094	O-2261	HAY-251-1977	DF-485E	PAC-101-3061	O-2262	STA-051-3783	O-1010				
AMP-301-1222	O-1205	HAY-051-2179	O-1049	HAY-251-1984	O-2195	PAC-101-3078	MS-201	STA-051-5014	G-4615				
AMP-301-1228	O-1211	HAY-051-2200	O-2261	HAY-251-2175	G-3003	PAC-101-3093	O-2139	STA-051-6225	O-1151				
AMP-301-1242	G-3157	HAY-051-2202	O-2270	HAY-251-2175	G-4067	PAC-101-3099	MS-200	STA-051-6226	O-1155				
AMP-301-1244	G-3146	HAY-051-2203	O-2165	HAY-251-5638	O-2195	PAC-101-3103	O-2195	STA-051-6227	O-1156				
AMP-301-1263	O-2001	HAY-051-2204	O-2133	HAY-251-5648	U-562	PAC-101-3107	O-2409	STA-051-7933	O-2134				
AMP-301-2668	O-2120	HAY-051-2205	O-2091	HAY-251-8755	G-3124	PAC-101-3133	G-5061	STA-051-7933	O-2094				
AMP-301-5549	G-3158	HAY-051-2206	O-1106	HAY-251-8755	G-3137	PAC-101-3133	O-2046	STA-051-8378	O-2259				
AMP-301-5549	G-4165	HAY-051-2208	G-4325	HAY-301-2080	G-3165	PAC-101-3134	O-2226	STA-061-5819	O-2209				
AMP-301-9091	G-4160	HAY-051-2217	O-1044	HAY-301-8873	G-3132	PAC-101-3135	O-2015	STA-061-5823	O-2111				
AQF-101-2138	O-2141	HAY-051-4043	O-2116	HAY-301-8881	K-6002	PAC-101-3148	O-2060	STA-061-6579	O-2255				
AQF-101-5039	G-3220	HAY-051-7004	O-2395	HAY-451-4206	O-2511	PAC-101-5287	O-2217	STA-061-7142	O-2041				
AQF-101-5040	G-3275	HAY-051-7010	K-6023	HAY-451-6400	O-2504	PAC-101-7225	O-2294	STA-061-9680	G-5120				
AQF-101-5149	O-2228	HAY-051-8241	O-2199	HAY-561-2149	O-2155	PAC-301-3156	G-4616	STA-101-1470	MS-851				
AQF-101-5150	O-2247	HAY-051-9390	O-1099	HAY-561-9009	O-2008	PAC-301-3177	O-2071	STA-101-2767	O-2067				
AQF-101-6691	O-2270	HAY-051-9392	O-2253	HAY-56-4042	120292	PAC-301-3178	O-2256	STA-101-3721	G-4441				
AQF-101-6694	O-2253	HAY-051-9469	O-2186	JAC-051-2701	G-4459	PEX-85-8824	O-2195	STA-101-3743	O-2195				
AQF-101-6715	O-2226	HAY-051-9787	O-2307	JAC-051-2710	103009PL	PEX-85-8825	O-1082	STA-101-3745	O-2306				
AQF-101-7222	G-3256	HAY-061-2093	G-5142	JAC-051-6418	O-2024	POL-201-1447	K-6022	STA-101-3746	O-2060				
AQF-101-7278	O-2262	HAY-061-2101	O-2128	JAC-051-6420	O-2181	POL-201-3268	O-2144	STA-101-4104	G-3249				
AQF-101-7737	MS-200	HAY-061-2108	G-5108	JAC-051-8788	G-5023	POL-201-3293	O-2024	STA-101-4104	G-3256				
AQF-101-7737	MS-1000	HAY-061-2121	O-2025	JAC-051-8880	O-2264	POL-201-3297	MS-1000	STA-101-5156	MS-1000				
AQF-101-8458	O-2211	HAY-061-2135	O-2067	JAC-051-8881	O-2153	POL-201-3302	O-2209	STA-101-5168	O-1011				
AQF-101-8473	G-3151	HAY-061-2140	O-2266	JAC-051-8882	G-5026	POL-201-3303	O-2001	STA-101-5836	G-4412				
AQF-101-8481	G-3240	HAY-061-2171	K-6001	JAC-051-8883	G-5060	POL-201-3305	O-2098	STA-101-5841	MS-163				
AQF-101-8507	MS-2131	HAY-061-3192	G-5106	JAC-101-5679	O-2139	POL-201-7828	O-2004	STA-101-6226	O-2231				
AQF-101-8565	MS-200	HAY-061-6294	O-2248	JAC-101-6204	O-2266	POL-201-8832	O-2329	STA-101-6583	O-2121				
AQF-101-8584	O-2025	HAY-061-6301	O-2208	JAC-101-6454	O-2059	PRE-101-6517	O-2024	STA-101-6585	G-3226				
AQF-101-8584	O-2252	HAY-061-6387	O-2515	JAC-101-6466	O-2058	PRE-101-8359	O-2228	STA-101-7158	O-2107				
ARN-201-8724	O-2300	HAY-061-8989	O-2339	JAC-101-6913	O-2224	PRE-101							

CROSS REFERENCE-ALADDIN TO SSC

ALD.#	SSC#	ALD.#	SSC#	ALD.#	SSC#	ALD.#	SSC#	ALD.#	SSC#	ALD.#	SSC#	ALD.#	SSC#	ALD.#	SSC#
GASKETS								O-RINGS							
G-001	G-3177	G-095	O-1209	G-196	G-4305	G-297	G-3112	O-002	O-1225	O-160	O-2217	O-263	O-2058	O-366	O-1054
G-002	G-3116	G-096	G-3165	G-197	G-3253	G-298	G-3258	O-004	O-2100	O-161	O-2604	O-264	G-5016	O-367	O-2211
G-003	G-3151	G-097	G-4409	G-198	G-4403	G-299	G-4209	O-005	O-2102	O-163	O-2214	O-265	G-5052	O-368	O-2017
G-004	G-3216	G-098	G-4324	G-199	G-4404	G-300	G-4335	O-006	G-4217	O-165	O-2223	O-266	G-5014	O-370	O-2010
G-005	G-3114	G-099P	G-3241	G-200	G-4334	G-301	G-5022	O-010	G-4254	O-168	O-2155	O-267	G-5010	O-371	G-5055
G-006	G-3117	G-099RS	G-4441	G-201	G-3133	G-303	G-4314	O-012	G-2247	O-169	O-2404	O-268	O-1030	O-372	O-1028
G-007	G-3257	G-100	G-3121	G-202	G-4309	G-305	G-5036	O-013	O-2167	O-170	O-1212	O-269	O-2140	O-373	O-1130
G-008	G-3162	G-101	G-3109	G-203	G-3136	G-307	G-5012	O-014	O-2240	O-171	O-2086	O-270	G-5017	O-374	O-1040
G-009	G-3107	G-102R	G-4122	G-204	G-3118	G-308	G-5057	O-015	O-2099	O-172	G-5126	O-271	K-6006	O-375	O-1080
G-010	G-3130	G-103	G-4264	G-205	G-3271	G-309	G-4432	O-016	G-4444	O-173	G-5124	O-272	O-2200	O-376	O-1127
G-011	G-3207	G-104	G-4273	G-206	G-4323	G-310	G-4256	O-017	O-2109	O-174	G-5108	O-273	O-2117	O-377	O-1033
G-012	G-3211	G-105	G-4332	G-207	G-3235	G-311	G-4223	O-018	O-2218	O-175	G-5106	O-274	O-2256	O-378	O-1050
G-013	G-3236	G-106	G-4121	G-208	G-3150	G-312	G-4246	O-019	O-2218	O-176A	G-5106	O-275	O-2067	O-379	O-1038
G-014	G-3104	G-107	G-4261	G-209	G-3122	G-313	G-4031	O-020	O-2138	O-177	O-1226	O-276	O-2139	O-380	O-1077
G-015	G-3126	G-108	G-4306	G-210	G-3122	G-314	G-4015	O-021	G-4248	O-178	K-6002	O-277	G-5142	O-381	O-1131
G-016	G-3152	G-109	G-4438	G-211	G-3250	G-315	G-4012	O-022	G-4233	O-179	O-2282	O-280	O-1126	O-382	O-1060
G-017	G-4128	G-110	G-3158	G-212	G-4226	G-316	G-5046	O-023	G-4287	O-180	O-2150	O-281	O-2125	O-384	O-2164
G-018	G-3240	G-110R	G-4165	G-213	G-4281	G-317	O-1210	O-024	O-2106	O-182	O-2028	O-282	O-2203	O-385	O-1095
G-018R	G-4033	G-111	G-4436	G-214	G-3233	G-318	G-4295	O-025	O-2141	O-183	O-2032	O-283	O-2114	O-389	O-2410
G-019	G-3248	G-112P	G-3170	G-215	G-4206	G-319	G-4405	O-026	O-2008	O-184	O-1062	O-283V	O-2522	O-390	O-2221
G-020	G-3139	G-112R	G-4116	G-216	G-4267	G-320	G-4114	O-027	O-2133	O-185	O-1056	O-284	O-2091	O-391	O-2223
G-021	G-3147	G-113	G-3020	G-217	G-4244	G-321	G-3143	O-027V	O-2611	O-186	O-2208	O-285	O-2177	O-392	G-5104
G-022	G-4003	G-113R	G-4065	G-218	G-3148	G-322	G-4439	O-030	O-2135	O-186V	O-2521	O-286	O-2066	O-392A	G-5105
G-023	G-4004	G-114	G-5034	G-219	G-3220	G-323	G-4294	O-030V	O-2502	O-188	O-2144	O-287	O-2189	O-394	O-1004
G-024	G-4027	G-115P	G-3006	G-220	G-4406	G-324	G-3144	O-032	O-2254	O-188V	O-2510	O-288	O-2239	O-395	O-2409
G-025	G-3246	G-115R	G-4001	G-221	G-4412	G-325	G-3209	O-032V	O-2505	O-189	O-2263	O-288V	O-2514	O-396	O-2137
G-027	G-3102	G-116	G-4419	G-222	G-4422	G-326	G-3180	O-034	O-2405	O-190	G-5117	O-289	O-1132	O-397	O-2087
G-028	G-4210	G-117	G-4251	G-223	G-3242	G-327	G-3269	O-037	O-2009	O-191	O-1063	O-292	O-1070	O-398	O-2261
G-029	G-4315	G-118	G-4208	G-224	G-4134	G-328	G-3149	O-039	O-2024	O-192	G-5024	O-294	O-1052	O-399	O-2414
G-030	G-4326	G-119	G-4275	G-225	G-4265	G-329	G-4014	O-039V	O-2519	O-193	O-1122	O-295	O-1064	O-400	O-2079
G-031	G-4011	G-120	G-3206	G-226	G-3146	G-330	G-3008	O-040	O-2231	O-194	O-1022	O-296	O-1051	O-401	O-2012
G-032	G-3204	G-121	G-4019	G-227	G-4215	G-331	G-4026	O-041	O-2040	O-195	O-1026	O-298	O-1058	O-402	O-2266
G-033	G-4414	G-122	G-4434	G-228	G-3268	G-332	G-3230	O-043	O-2270	O-196	O-1037	O-299	O-2209	O-403	O-2004
G-034	G-4327	G-123	G-4410	G-229	G-4312	G-333	G-3225	O-045	O-2406	O-197	O-1121	O-300	G-5045	O-404	G-5053
G-035	G-4240	G-124	G-4252	G-230	G-3009	G-334	G-4228	O-047	O-2124	O-198	O-1090	O-301	O-2226	O-405	O-1120
G-036	G-3023	G-125	G-3138	G-231	G-3011	G-335	G-3304	O-048	O-2128	O-199	O-1045	O-302	O-2080	O-406	G-5131
G-037	G-5048	G-126	G-3154	G-232	G-4417	G-336	G-3132	O-049	O-2195	O-200	O-1025	O-303	O-2104	O-407	O-2122
G-040	G-3259	G-127C	G-3202	G-233	G-4232	G-337	G-4250	O-050	O-2006	O-201	O-1031	O-304	O-2216	O-408	O-2127
G-041	G-4242	G-127R	G-4186	G-234	G-4225	G-338	G-4202	O-054	O-2165	O-202	G-5114	O-305	O-1215	O-409	O-2304
G-042	G-5043	G-130	G-4230	G-235	G-4312	G-339	G-4263	O-056	G-4238	O-203	O-2188	O-306	O-1041	O-410	O-1012
G-043	G-3108	G-132	G-3217	G-236	G-4312	G-341	G-4263	O-067	G-5129	O-204	G-4253	O-307	O-2212	O-411	O-2181
G-044	G-3256	G-133	G-4203	G-237	G-5050	G-342	G-4408	O-068	G-4322	O-205	G-5111	O-308	O-1034	O-412	O-1129
G-044A	G-3249	G-134	G-4427	G-238	G-5051	G-343	G-4266	O-069	O-2264	O-206	G-5112	O-309	O-1052	O-413	O-1065
G-045	G-3266	G-135	G-3153	G-239	G-3022	G-344	G-4201	O-070	G-4418	O-207	O-1018	O-312	O-1023	O-414	K-6003
G-046	G-3166	G-136	G-3176	G-240	G-3145	G-345	O-1217	O-071	O-2068	O-208	O-2038	O-313	O-2101	O-415	G-5028
G-047	G-3219	G-137	G-3172	G-241	G-4286	G-346	G-4220	O-072	O-2119	O-209	O-1016	O-314	O-1069	O-416	K-6001
G-048	G-3224	G-138	G-4125	G-242	G-4304	G-347	G-4424	O-073	G-4285	O-210	G-5006	O-315	O-2092	O-417	O-5061
G-049	G-3111	G-139	G-4433	G-243	G-4224	G-349	G-4407	O-074	O-2121	O-211	O-2029	O-316	O-1022	O-418	O-2046
G-050	G-3103	G-140	G-3021	G-244	G-4255	G-354	G-4234	O-076	G-5039	O-212	O-1035	O-317	O-1027	O-419	O-2015
G-051	G-3105	G-141	G-3171	G-245	G-4442	G-355	G-4222	O-079	G-5003	O-213	O-2060	O-318	O-2172	O-420	O-2219
G-052	G-3229	G-142	G-4102	G-246	G-4282	G-356	G-4111	O-080	O-2228	O-214	O-2257	O-319	O-2030	O-421	O-1124
G-053	G-3140	G-143	G-4258	G-247	G-4303	G-357	G-3017	O-081	O-2417	O-215	O-220	O-320	O-2044	O-422	O-1124
G-054	G-3226	G-144	G-5041	G-248	G-4310	G-358	G-4007	O-082	O-2402	O-216	O-2020	O-321	O-2243	O-423	O-2105
G-055	G-3178	G-145	G-5023	G-249	G-4211	G-359	G-5008	O-083	O-2002	O-217	O-2020	O-322	O-1036	O-424	O-1017
G-056	G-3127	G-146	O-1125	G-250	G-4316	G-361	G-4018	O-085	O-1074	O-218	O-2234	O-323	O-1036	O-425	O-1123
G-057	G-3275	G-147	G-5027	G-251	G-4316	G-363	G-3277	O-086	O-1073	O-219	O-2255	O-324	O-2224	O-426	O-2408
G-058	G-3120	G-150	G-3124	G-252	G-4297	G-364	G-4216	O-087	O-1039	O-220	O-225V	O-325	O-2106	O-427	O-1001
G-059	G-4431	G-151	G-3131	G-253	G-4311	G-365	G-3129	O-088	O-1067	O-221	O-2020	O-326	O-2129	O-430	O-1099
G-060	G-4005	G-152	G-3173	G-254	G-4311	G-366	G-3208	O-089	O-1032	O-222	O-2020	O-327	O-2116	O-431	O-2001
G-061	G-4017	G-153	G-3137	G-255	G-4025	G-367	G-4426	O-090	O-1014	O-223	O-2020	O-328	O-2089	O-432	O-1076
G-062	G-4008	G-154	G-3016	G-256	G-4310	G-368	G-3123	O-091	O-1008	O-224	O-2252	O-329	O-2026	O-433	O-1128
G-063	G-4115	G-155	G-3003	G-257	G-4333	G-369	G-3014	O-092	O-1008	O-225	O-2146	O-330	O-2095	O-434	G-5058
G-064P	G-3125	G-156	G-3018	G-258	G-3274	G-370	G-4284	O-093	O-1042	O-226	O-2272	O-332	G-5035	O-435	O-1021
G-064R	G-4119	G-157	G-3001	G-259	G-3025	G-371	G-4221	O-096	O-1014	O-227	O-2007	O-333	O-1029	O-436	O-2160
G-065	G-3168	G-157R	G-4064	G-260	G-3245	G-372	G-4440	O-099	O-1048	O-228	O-231V	O-334	O-1007	O-437	O-2053
G-066	G-4336	G-158	G-3019	G-261	G-4262	G-373	G-3237	O-100	O-1133	O-229	O-2224	O-335	O-1006	O-438	O-2118
G-068	G-3128	G-159	G-4110	G-262	G-3134	G-374	G-4260	O-101	O-1015	O-230	O-2278	O-336	O-2224	O-439	O-2175
G-069	G-3228	G-160	G-4280	G-263	G-3101	G-374	G-4260	O-102	O-1043	O-231	O-2172	O-337	O-1071	O-440	O-2098
G-070	G-3255	G-161	G-4328	G-264	G-3254	G-375	G-4002	O-103	O-1106	O-232	O-1055	O-338	O-1116	O-441	

CROSS REFERENCE-HYDROVALVE TO SSC

ALD.#	SSC#	ALD.#	SSC#	HYD.#	SSC#	HYD.#	SSC#	HYD.#	SSC#	HYD.#	SSC#	HYD.#	SSC#	HYD.#	SSC#
PLASTIC PARTS															
7000	ST-358	GOKIT31	R-6123	K-1155	G-3144	K-1627	E-6506	K-2755	O-2209	K-3644	G-3256	K-5778	G-4212	K-5887	O-2280
7008	RF-455	GOKIT32	R-6125	K-1169	G-3214	K-1647	O-2025	K-2756	O-2262	K-3645	O-1010	K-5779	O-2106	K-5888	O-2141
801	WP-20	GOKIT33	R-6124	K-1170	G-3218	K-1648	O-2041	K-2760	G-3256	K-3646	O-1074	K-5780	O-2105	K-5889	O-2041
802	WP-21	GOKIT34	R-6141	K-1203	G-3209	K-1654	DF-485C	K-2761	O-2116	K-3647	O-1073	K-5781	O-2116	K-5890	O-2282
913	VP-696	GOKIT35	R-6142	K-1204	G-3006	K-1655	DF-485D	K-2762	O-2167	K-3726	G-4284	K-5784	G-4443	K-5891	O-2082
914	VP-695	GOKIT36	R-6140	K-1211	G-3166	K-1656	DF-485E	K-2763	E-6503	K-3770	G-3236	K-5785	G-4325	K-5892	O-2002
915	VP-697	GOKIT37	R-6112	K-1216	G-3143	K-1660	RF-481	K-2764	O-2228	K-4015	O-2041	K-5786	G-4313	K-5893	O-2100
916	VP-698	GOKIT38	R-6133	K-1217	O-2020	K-1730	O-1039	K-2768	G-3220	K-4018	O-2095	K-5788	O-2105	K-5894	O-1062
917	SF-450	GOKIT40	R-6146	K-1226	G-3282	K-1732	O-2106	K-2769	O-2032	K-4040	O-2114	K-5789	O-2080	K-5895	O-1056
918	SF-451	GOKIT41	R-6147	K-1227	G-3125	K-1751	O-2133	K-2770	K-6008	K-4048	G-4327	K-5790	G-4120	K-5896	G-4324
919	HA-460	GOKIT42	R-6148	K-1227	G-3125	K-1753	G-5104	K-2771	K-6009	K-4125	G-3175	K-5791	O-1060	K-5897	G-4296
B-152	BA-691	GOKIT43	R-6149	K-1232	G-3128	K-1754	G-3239	K-2775	O-2262	K-4135	O-1029	K-5792	O-2195	K-5898	O-1071
B-167	BA-693	GOKIT44	R-6150	K-1233	G-3250	K-1755	G-5146	K-2777	O-2172	K-4136	O-1063	K-5793	O-2262	K-5899	O-2189
B-168	BA-690	GOKIT45	R-6145	K-1234	G-3178	K-1759	HA-460	K-2778	O-2028	K-4277	O-2218	K-5794	G-4221	K-5900	O-2059
B-169	BA-692	GOKIT46	R-6121	K-1239	G-5039	K-1761	G-3011	K-2779	O-2106	K-4465	G-4298	K-5795	O-2129	K-5901	O-2215
B-220	BA-694	GOKIT47	R-6144	K-1240	G-5003	K-1762	G-3009	K-2780	G-4104	K-4471	O-2402	K-5796	G-4002	K-5904	O-1100
		GOKIT49	R-6170	K-1241	G-4290	K-1781	G-3170	K-2782	O-2041	K-4491	O-2124	K-5797	G-3141	K-5905	O-2024
		GOKIT50	R-6171	K-1242	G-4227	K-1801	G-4294	K-2783	E-6504	K-4494	O-2041	K-5798	G-4290	K-5906	O-2071
		GOKIT51	R-6155	K-1244	G-4124	K-1802	G-3230	K-2792	O-2236	K-4620	O-2111	K-5799	O-2195	K-5907	O-1048
		GOKIT52	R-6156	K-1258	G-3020	K-1803	G-3225	K-2793	G-5046	K-4621	O-1082	K-5800	O-2160	K-5908	O-2256
		GOKIT54	R-6175	K-1260	O-2121	K-1804	G-3145	K-2795	O-2266	K-4625	G-4409	K-5801	O-2053	K-5909	O-2115
		GOKIT55	R-6158	K-1263	G-5053	K-1805	G-4309	K-2796	O-2139	K-4839	G-4337	K-5802	O-2017	K-5910	O-2040
		GOKIT57	R-6160	K-1264	G-3150	K-1965	G-4134	K-2797	G-5016	K-4840	G-4008	K-5803	O-2106	K-5911	O-1070
		GOKIT58	R-6162	K-1265	O-2112	K-1966	G-3203	K-2800	O-2195	K-4939	O-2006	K-5804	O-2208	K-5912	O-2015
		GOKIT59	R-6166	K-1266	G-3259	K-2009	O-2002	K-2801	O-2124	K-4944	O-2195	K-5805	G-4310	K-5914	O-2226
		GOKIT60	R-6167	K-1267	O-2017	K-2011	O-2200	K-2802	O-2135	K-5030	O-2124	K-5806	G-5024	K-5915	O-2080
		GOKIT61	R-6165	K-1268	O-2134	K-2014	O-2104	K-2803	O-2133	K-5035	O-2144	K-5807	O-2142	K-5916	O-2409
		GOKIT62	R-6168	K-1269	G-5034	K-2016	O-2188	K-2804	O-2261	K-5060	O-2024	K-5808	G-4278	K-5917	G-5061
		GOKIT63	R-6164	K-1271	O-2038	K-2019	O-2126	K-2805	O-2091	K-5063	O-2209	K-5809	G-4237	K-5918	O-2294
		GOKIT64	R-6163	K-1272	O-2135	K-2020	O-2024	K-2806	O-1106	K-5098	O-2256	K-5810	O-2175	K-5919	O-2214
		GOKIT65	R-6161	K-1274	O-2209	K-2021	O-2115	K-2807	O-2270	K-5187	RF-455	K-5811	O-2067	K-5920	O-2007
				K-1282	O-2086	K-2022	O-2068	K-2808	O-1044	K-5221	O-2224	K-5813	G-4311	K-5921	O-2195
				K-1286C	G-3202	K-2023	G-4285	K-2809	O-2165	K-5225	O-2024	K-5814	O-1042	K-5924	G-3163
				K-1286R	G-4186	K-2024	G-5045	K-2810	O-1049	K-5227	G-5031	K-5815	O-2239	K-5927	G-3155
				K-1301	G-3283	K-2025	O-2054	K-2811	O-2116	K-5236	O-2058	K-5816	O-2226	K-5930	G-3271
				K-1302	G-4133	K-2026	E-6501	K-2812	O-1215	K-5243	O-2095	K-5818	O-2224	K-5931	O-2090
				K-1303	G-4132	K-2027	O-2026	K-2813	O-1054	K-5244	O-2181	K-5819	O-2165	K-5932	G-5112
				K-1306	O-2025	K-2029	O-1059	K-2814	O-2095	K-5245	O-1116	K-5820	O-2227	K-5933	G-5114
				K-1307	O-2152	K-2030	O-2223	K-2815	O-2164	K-5246	G-5023	K-5821	O-2256	K-5934	O-2124
				K-1308	O-2226	K-2031	O-1211	K-2816	G-4280	K-5250	G-4223	K-5822	G-5035	K-5936	O-2261
				K-1311	O-2255	K-2032	O-1212	K-2817	O-2067	K-5251	O-2218	K-5823	O-2059	K-5937	O-2253
				K-1312	O-2240	K-2033	O-2239	K-2819	O-2248	K-5254	G-3157	K-5826	O-2153	K-5940	O-2106
				K-1313	G-4131	K-2035	G-3149	K-2820	O-2248	K-5255	G-3158	K-5827	O-2264	K-5942	O-2200
				K-1314	G-4030	K-2036	G-4440	K-2821	O-2256	K-5259	O-2236	K-5828	O-2248	K-5943	O-2209
				K-1316	G-4026	K-2037	G-3148	K-2822	O-2280	K-5263	O-2134	K-5829	G-5026	K-5944	O-2067
				K-1317	G-4114	K-2038	O-1014	K-2823	O-2124	K-5306	O-2214	K-5830	O-1101	K-5945	O-2086
				K-1318	G-4405	K-2039	O-1060	K-2824	O-2155	K-5404	O-2282	K-5831	O-2224	K-5946	O-2249
				K-1322	O-2104	K-2040	O-2040	K-2825	O-2117	K-5411	G-4319	K-5832	O-2034	K-5947	G-3247
				K-1336	G-5108	K-2041	O-2114	K-2826	G-3002	K-5535	DF-485A	K-5833	O-2220	K-5948	G-4123
				K-1367	G-3010	K-2042	O-2203	K-2827	G-3003	K-5614	G-3012	K-5834	O-2090	K-5949	O-2209
				K-1383	O-2195	K-2043	G-4309	K-2830	O-2095	K-5618	WP-20	K-5836	O-2199	K-5950	O-2189
				K-1384	O-2060	K-2044	O-2142	K-2867	G-3238	K-5685	O-2106	K-5837	O-2049	K-5951	O-2079
				K-1385	O-1082	K-2045	O-2266	K-2868	SF-451	K-5692	O-2175	K-5838	O-2058	K-5952	O-1067
				K-1386	O-1115	K-2046	G-4295	K-2945	G-3006K	K-5693	O-2220	K-5839	O-2278	K-5953	G-3255
				K-1387	O-1102	K-2048	G-4328	K-2954	R-6109	K-5730	O-2090	K-5841	G-3026	K-5954	O-2208
				K-1388	O-1041	K-2049	G-3273	K-2955	R-6110	K-5731	G-5009	K-5842	G-3021	K-5955	O-2144
				K-1389	G-3242	K-2051	O-2104	K-2965	G-4441	K-5732	O-2008	K-5843	O-2165	K-5956	O-2103
				K-1389	G-4290	K-2052	G-3022	K-2966	G-4253	K-5733	O-2150	K-5844	O-2080	K-5957	O-2216
				K-1391	WP-04	K-2054	G-4439	K-2969	O-2099	K-5734	K-6002	K-5845	O-2247	K-5958	O-2024
				K-1392	WP-06	K-2055	O-1102	K-2970	G-3277	K-5738	O-2133	K-5846	O-2054	K-5959	O-2030
				K-1393	WP-07	K-2057	O-1159	K-2982	O-1217	K-5739	O-2261	K-5847	O-2205	K-5960	O-2044
				K-1394	WP-08	K-2058	O-1119	K-2983	O-2247	K-5740	O-2128	K-5848	O-2131	K-5961	O-2243
				K-1395	WP-09	K-2100	G-3004	K-2991	G-4425	K-5742	G-3262	K-5850	O-2222	K-5962	O-2040
				K-1396	WP-10	K-2102	O-2082	K-2992	G-3278	K-5743	G-4299	K-5851	O-2231	K-5963	O-2270
				K-1397	WP-11	K-2103	O-2135	K-2995	G-4305	K-5744	G-4243	K-5852	O-2271	K-5965	O-2221
				K-1398	WP-12	K-2104	O-2208	K-2997	G-4220	K-5745	G-3262	K-5853	O-2203	K-5967	O-2189
				K-1420	O-1226	K-2105	O-2263	K-3000	G-4029	K-5746	G-3137	K-5854	O-2203	K-5968	O-2155
				K-1424	O-2247	K-2106	O-2144	K-3001	O-1041	K-5747	G-3124	K-5855	O-2231	K-5969	O-2090
				K-1425	O-2138	K-2111	R-6115	K-3002	O-2024	K-5749	O-2098	K-5856	O-1015	K-6023	O-2115
				K-1426	O-2167	K-2112	K-6005	K-3003	O-2170	K-5750	G-4229	K-5859	G-3226	K-6025	G-5114
				K-1429	O-2128	K-2125	R-6105	K-3004	O-2141	K-5751	G-5033	K-5860	O-2266	K-6027	O-2226
				K-1430	O-2058	K-2126	R-6103	K-3005	O-2212	K-5752	O-2020	K-5862	G-3261	K-6028	O-1050
				K-1431	O-1095	K-2127	R-6106	K-3006	O-2205	K-5753	O-2040	K-5863	G-3164	K-6029	O-2058

A.O. Smith Type Motor Parts	86-87	Handrail Stabilizing Plugs	95	Return Fittings	104
Adhesive-For O-ring Cord	86	Hooks	96	Reverse Cross Ref. (SSC# Order)	39-59
Air Bleeder Valves	112	Hose Adapter	105	ROKIT Type Kits	76-78
Aladdin Part # Cross Reference	115-116	Hose Bibbs	110	Rope Clamps	97
Alphabetical Parts Listing	14-38	Hose Caps	111	Rope Eyes	97
Anchors-Ladder	95-96	Hose Clamps	106	Rough Service Bulbs	94
Aquador Skimmer System	101	Hose Connector	105	Rubber Pipe Couplings	105
Armature Holding Tool	89	Hose Cuffs	105	Saddle Valve	110
Ball Bearings	89	Hose Parts	111	Safety Cover Hardware	98
Ball Valves	108	Hydrovalve Part # Cross Reference	116	Schrader Valve	82
Baskets	102	Impeller Wedge	89	SCP Part # Cross Reference	114
Bearings	89	Impeller Wrenches	89	Screws	100
Boiler Drains	109	Ladder Foot Bumper and Kit	95	Seals	71-72
Brass Ball Valves	108	Ladder Replacement Parts	95-96	Service Tools	89-92
Brass Brush	91	Light Wedge	91	Sewage Ejector Check Valve	109
Bug Buster	101	Liquid Filled Gauges	81-82	Shaft Extensions	86
Bulbs-Rough Service	94	Lubricants	92-93	Shaft Puller	89
Bump Shaft C-Clip	108	Magnetic Pole Tip	92	Sheet Metal Screws	100
Bumpers-Ladder	95	Main Drain Sealing Ring	104	Silicone Lubricant	92
Capacitors	88	Mfr.'s Part # Cross Reference	14-38	Sillcock Key	110
Century Type Motor Parts	87	Mechanical Packing	112	Sillcocks	110
Check Valves	109	Motor Bearing Puller	89	Single Union Ball Valves	108
Compound Gauges	80	Motor Capacitors	88	Skimmer Covers	102
Compression Couplings	109	Motor Parts	86-90	Skimmer Faceplate Covers	101
Cord Stoppers	91	Needle Valves	82	Skimmer Faceplates	101
Couplings-Pipe	105, 109	No-Hub Couplings	105	Skimmer Screws	100
Cross Reference-Aladdin to SSC	115-116	OEM Part Number Cross Reference	14-38	Slick Pick Impeller Cleaner	90
Cross Reference-By Equipment	1-13	O-ring / Gasket Kits	59	Slide Flange Hardware	96
Cross Reference-By Manufacturer's #	14-38	O-ring Box	86	Socket Gutter and Grate	102
Cross Reference-By OEM #	14-38	O-ring Cord	85	South Central Pool Supply Cross Ref.	114
Cross Reference-By Popular Seals	71-72	O-ring Cord Adhesive	86	Stair Screws	100
Cross Reference-Hydrovalve to SSC	116	O-ring List (SSC# Order)	39-51	Step Section Gasket	100
Cross Reference-SCP to SSC	114	O-ring Puller	91	Sticky Spray	93
D.E. Scoop	90	O-ring Sizing Guide	86	Stop and Waste Valves	110
Dollar Plugs	100	Outlet Fittings	104	Teflon Lubricant	92
Drain Cocks	112	Packing	112	Teflon Paste	92
Duct Tape	93	Picture Guide (Gaskets)	60-70	Teflon Tape	92
Dust Masks	94	Pipe Couplings	105-109	Tek Screws	100
Equipment Cross Reference	1-13	Pipe Dope	92	Test Caps	105
Escutcheons	96	Pipe Extensions	107	Tie Down Straps	94
Eyeball Seat Removal Tools	105	Pipe Flange Bolts and Nuts	113	Tools	89-92
Faceplates (Skimmer & Return)	101	Pipe Flange Gaskets	112-113	Torque Wrench	106
Fiberglass Tape Kit	93	Pipe Repair Clamps	106	Transition Couplings	105
Filter O-ring / Gasket Kits	76-78	Pipe Repair Tape	93	Unions	107
Fittings-Flow	104	Plastic Case Gauges	80	Vacuum Gauges	80
Frost Free Sillcocks	110	Plastic Goods	101-105	Vacuum Plates	102
G.E. Type Motor Parts	87-88	Plugs-Brass	112	Valves-PVC, Brass	109-110
Gasket Cutting Shears	83	Pool Hardware	95-98	Vibro-Insulators	94
Gasket List (SSC# Order)	52-59	Pressure Gauges	76-82	Vinyl Gloves	94
Gasket Picture Guide	60-70	Pump / Motor Shaft Extensions	86	Water Test Gauges	82
Gasket Removing Solution	93	Pump Repair / Service Kits	73-75	Wedges-Ladder	96
Gasket Sheets	83-85	Pump Seals (SSC# Order)	71-72	Winterizing Plugs	99
Gauges	79-82	PVC Ball Valves	108	Winterizing Plugs-Plastic	99
Gloves-Vinyl	94	PVC Fittings	107	Wire Saw	91
GOKIT Type Kits	73-75	PVC Unions	107	Wire Ties	94
Grate Insert Fitting	103	PVC Wire Saw	91	Zinc Plate	91
Grommets	94	Return Fitting Faceplates	104	Zoom-Spout Oiler	93

Use SSC's Website to Find Your Replacement Parts and Order Online!

- Place orders online using our shopping cart feature.
- Find more than 2700 different listings of gaskets, O-rings and seals using our multi-functional "Part Search" engine. Part listings are also accompanied by a picture for your reference.
- Take advantage of our unique "View Past Orders" section to look at previous orders you've placed. You can then order from this list.
- This Website also enables you to save the current order you are working on by using our "Save Cart" feature. You can come back to it at another time if you are interrupted or save all of your orders for future reference. These can be activated to be your current order/cart at any time.
- Registration is required. This ensures that only Pool & Spa Dealers and Service Companies, not the general public, can see pricing and use the shopping cart.
- Download the SSC catalog, price list and all of our literature from the website.

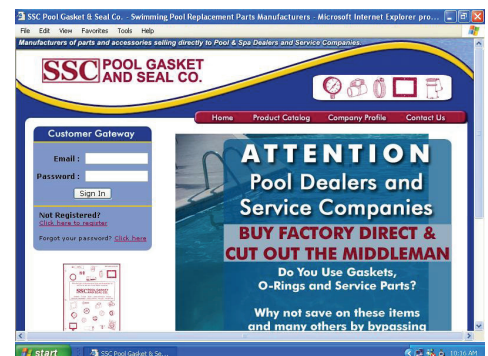

www.poolgasket.com